



APPLICATION AND PRODUCT GUIDE



Experience The Difference!

WWW.MEYERPRODUCTS.COM

APPLICATION AND PRODUCT GUIDE



RETAILER HOTLINE IMPORTANT INFORMATION

**216-486-1313 or
800-877-PLOW (7569)**

Enter your custom PIN # above

Dear Meyer Retailer,

Since inventing the automotive snowplow more than 80 years ago, Meyer has worked hard to provide reliable equipment that makes a tough job easier. To stay true to our purpose, Meyer recently completed a transformation that ensures we continue to provide you the very best products in the industry.

Meyer Products...

A New Company, 80 Years In The Making.

The Meyer transformation includes:

- Investing millions of dollars in new manufacturing equipment
- Redesigning all our products
- Hiring a new management team
- Backing our equipment with the longest, most comprehensive warranty in the business

With these changes, I invite you to **experience the difference** in our **reliability, performance** and **ease of use**.

Backed by an industry-leading 3- to 5-year warranty, our equipment will minimize your downtime. New plow designs let you push more snow faster and leave the job site clearer. Plows take seconds to mount using our new mounting systems.

As you head into another challenging winter, there is no better time to **Experience the Meyer Difference**. We are confident your customers and crew will appreciate the results that the new Meyer delivers.

Sincerely,

Andrew L. Outcalt
President, Meyer Products LLC

Table of Contents

Mount Selection	4-15
Snow Plows	
Drive Pro™.....	16-17
Lot Pro™.....	18-19
Road Pro™.....	20-21
Diamond Edge – Contractor Plow.....	22-23
Super-V – Contractor Plow.....	24-25
Classic Plows – TM Series.....	26
Classic Plows – STL and ST Series.....	27
Classic Plows – C Series.....	28
Classic Plows – HML and HM Series.....	29
Classic Plows – AG Series.....	30
Snow Plow Accessories	31-34
Spreaders	
Broadcast Spreaders – Hotshots.....	36-37
Tailgate Spreaders – 240, Mate™ and Mini Jr.™.....	38-39
Tailgate Spreaders – Blaster.....	40-41
Insert Hopper Spreaders – LPV and PV.....	42-43
Insert Hopper Spreaders – MDV and PolyHawk.....	44-45
Dump Truck Spreaders – UTG and RTG.....	46-47
Dump Truck Crossover Conveyor.....	48-49
Anti-Icers.....	50-51
Spreader Accessories	52-59
Insert Dump Body	60-61
Allied Product Information	
Timbren.....	62-65
Whelen Safety Lights.....	66
ShurTrax.....	67
Plow Carts.....	67
Resources	
OEM Vehicle Recommendations.....	68-71
Headlight Adapter Cross-Reference.....	72-73
Meyer Brand Features.....	74-79
Limited Warranties	80-81

HOW TO USE THIS GUIDE

STEP 1:

Match the vehicle with a mounting system and the desired plow:

MOUNT SELECTION – EZ MOUNT PLUS

Year	Vehicle	Mount #	Headlight Adapter	DP 7.6	STL	ST	C	LP	DE	HML	SV	Timbren
CHEVROLET/GMC												
												Front Rear
1988 to 2000	K1500 PICKUP 4/WD (7.5 Only)	17119	Pgs. 72-73	X		X			X			GMFK35C GMRCK25
1992 to 1994	BLAZER, JIMMY, YUKON (7.5 Only)	17119	Pgs. 72-73			X	X	X	X			GMFK35C GMRCK25
	SUBURBAN 4/WD (7.5 Only)											GMFK35C GMRCK25
1999 to 2002	K1500 PICKUP 4/WD (7.5 Only)	17140	07108	X		X			X			GMFK15A GMRCK15S
	1999 NEW FRAME											GMFK15A GMRCK15S

STEP 2:

Select desired plow, accessories, lift frame, PAF/SAF carton, hydraulic unit and plow lights.

Drive Pro 7'6" Moldboard and Accessories										
PART NO.	DESCRIPTION	CUTTING EDGES			DEFLECTORS			CURB GUARDS	HYDRAULIC LOCK	REPLACEABLE SHOES
		Steel	Rubber	Urethane	Molded	Rubber	Poly			
09275	DP 7.6 STEEL	08178*	08189	09224	12039	08109	12078	08344	07695C	09127*
09278	DPP 7.6 POLY	08178*	08189	09224	12039	08109	12078*	08344	07695C	09127*

* Included with moldboard

Lift Frame		PAF/SAF Carton		Hydraulic Unit <small>ONLY ORDER 1</small>		Plow Lights <small>ONLY ORDER 1</small>	
PART NO.	DESCRIPTION	PART NO.	DESCRIPTION	PART NO.	DESCRIPTION	PART NO.	DESCRIPTION
16531	CLF PLUS	16546	PAF PLUS MOUNT	15988	E-58H HYD CARTON	07234	NITE SABER I
11255	LF CLASSIC	16548	PAF CLASSIC MOUNT	15602	E-58H 24V HYD CTN	07550	NITE SABER II
Included in 16556		16556	PAF HAT/TUG	08878	CENTRAL HYD KIT	07404	EURO 24V

KEY:

PAF = Pivot A-Frame
SAF = Sector A-Frame

STEP 3:

Drive Pro Poly System for K1500 (2000)

Part numbers required for a complete plow system that fits a 2000 K1500 New Frame Vehicle with an EZ Mount Plus and a DPP 7.6 poly plow with Nite Saber® II lights, rubber deflector and curb guards added.

Plow Systems*							Accessories			
Mount	Headlight Adapter	Moldboard	Lift Frame	PAF/SAF Carton	Hydraulic Unit	Plow Lights	Cutting Edge	Deflector	Curb Guard	Hydraulic Lock
17140	07108	09278	16531	16546	15988	07550		08109	08344	

* Must order one of each to make a complete plow system

MOUNT SELECTION – EZ MOUNT PLUS



Year	Vehicle	Mount #	Headlight Adapter	DP 7.6	STL	ST	C	LP	DE	HML	SV	Timbren	
												Front	Rear
CHEVROLET/GMC													
1988 to 2000	K1500 PICKUP 4/WD (7.5 Only)	17119	Pgs. 72-73	X		X			X			GMFK35C	GMRCK25
1992 to 1994	BLAZER, JIMMY, YUKON (7.5 Only)	17119	Pgs. 72-73			X	X	X	X			GMFK35C	GMRCK25
	SUBURBAN 4/WD (7.5 Only)											GMFK35C	GMRCK25
1999 to 2002	K1500 PICKUP 4/WD (7.5 Only)	17140	07108	X		X			X			GMFK15A	GMRCK15S
	1999 NEW FRAME											GMFK15A	GMRCK15S
2000 to 2002	K1500 YUKON / YUKON XL	17140	07108	X	X							GMFK15A	GMRCK15S
2000 to 2002	TAHOE / SUBURBAN 4/WD	17140	07108	X	X							GMFK15A	GMRCK15S
2003 to 2007	K1500 PICKUP 4/WD (7.5 Only)	17140	07400	X		X			X			GMFK15A	GMRCK15S
	1999 NEW FRAME											GMFK15A	GMRCK15S
2003 to 2006	K1500 YUKON / YUKON XL	17140	07400	X		X						GMFK15A	GMRCK15S
2003 to 2006	TAHOE / SUBURBAN 4/WD	17140	07400	X								GMFK15A	GMRCK15S
2001 to 2002	K1500 HD CREW CAB	17139	07108	X	X							GMFK25S	GMRCK25S
2003 to 2009	K1500 HD CREW CAB	17139	07400	X	X							GMFK25S	GMRCK25S
2007 to 2009	K1500 YUKON / YUKON XL	17165	07334	X	X							GMFK15C	GMRCK15D
	WITHOUT VYU OPTION											GMFK15C	GMRCK15D
2007 to 2009	K1500 YUKON / YUKON XL (VYU)	17165	07343	X	X							GMFK15C	GMRCK15D
2007 to 2009	K1500 AVALANCHE SUBURBAN 4WD	17165	07344	X	X							GMFK15C	GMRCK15D
2007 to 2009	K1500 PICKUP 4/WD (7.5 Only)	17165	07333	X		X			X			GMFK15C	GMRCK15D
1988 to 2000	K2500 and K3500 4/WD (1988 FRAME)	17119	Pgs. 72-73				X	X	X		X	GMFK35C	GMRCK25
	K3500 DUAL REAR (1988 FRAME)											GMFK35C	GMRCK25
1991 to 2002	HD 3500 2/WD (8.5 -10.0)	17127	Pgs. 72-73				X	X	X	X	X	GMF25HDA	GMR35HDM
	15,000 lb. G.V.W.R.											GMF25HDA	GMR35HDM
1999 to 2002	K2500 / K2500HD / K3500	17139	Pgs. 72-73				X	X	X		X	GMFK25S	GMRCK25S
2000 to 2002	K2500 YUKON / YUKON XL (7.5 Only)	17139	07108	X		X			X			GMFK25S	GMRSB4S
2002	K2500 AVALANCHE (7.5 Only)	17139	07108	X		X			X			GMFK25S	GMRSB4S
	SUBURBAN 4/WD (7.5 Only)											GMFK25S	GMRSB4S
2003 to 2009	K2500 YUKON / YUKON XL (7.5 Only)	17139	07400	X		X			X			GMFK25S	GMRSB4S
2003 to 2009	K2500 AVALANCHE (7.5 Only)	17139	07400	X		X			X			GMFK25S	GMRSB4S
	SUBURBAN 4/WD (7.5 Only)											GMFK25S	GMRSB4S
2003 to 2009	K2500 / K2500HD / K3500	17139	07400				X	X	X		X	GMFK25S	GMRCK25S
2003 to 2009	C2500 / C3500 PICKUP 2WD/4WD	17139	07400				X	X	X		X	GMFK25S	GMRCK25S
2007 to 2008	K2500 YUKON / YUKON XL (7.5 Only)	17139	07334	X		X			X			GMFK25S	GMRSB4S
	WITHOUT VYU OPTION											GMFK25S	GMRSB4S
2007 to 2009	K2500 YUKON / YUKON XL (7.5 Only)	17139	07343	X		X			X			GMFK25S	GMRSB4S
	WITH VYU OPTION											GMFK25S	GMRSB4S
2007 to 2009	K2500 AVALANCHE (7.5 Only)	17139	07344	X		X			X			GMFK25S	GMRSB4S
	SUBURBAN 4/WD											GMFK25S	GMRSB4S
2007 to 2009	K2500 / K2500HD / K3500 4/WD	17139	07333				X	X	X		X	GMFK25S	GMRCK25S
2003 to 2009	C4500 / C5500 4/WD 16000 GVWR	17158	Pgs. 72-73				X	X	X	X	X	GMFTK	GMRP30MH
NEW MOUNTS													

MOUNT SELECTION – EZ MOUNT PLUS (CONT.)





Year	Vehicle	Mount #	Headlight Adapter	DP 7.6	STL	ST	C	LP	DE	HML	SV	Timbren	
FORD												Front	Rear
1992	BRONCO 3,800 lb. F.G.A.W.R.	17126	07102	X		X			X			FF1504H	FAR001
1992 to 1996	F150 PICKUP / BRONCO (7.5 Only)	17126	07102	X		X			X			FF1504H	FR250SDE
1997 to 1999	F150 PICKUP 4/WD	17124	07102	X	X							FF150974A	FR1525HD
2000 to 2003	F150 PICKUP 4/WD (7.5 Only)	17124	07102	X		X			X			FF150974A	FR1525HD
	7,700 lb. G.V.W.R.			X		X			X			FF150974A	FR1525HD
2004 to 2008	F150 PICKUP 4/WD (7.5 Only)	17141	07417	X		X			X			FF150974A	FR1525HD
	8,200 lb. G.V.W.R.			X		X			X			FF150974A	FR1525HD
2009 and Later	F150 PICKUP 4/WD (7.5 Only)	17171	07417	X		X			X			FF150F	FR1504D
	8,200 lb. G.V.W.R.			X		X			X			FF150F	FR1504D
1992 to 1998	F250 4600 FGAWR 4WD	17125	07102				X	X	X		X	FF2504A	FR250DE
1997 to 1999	F250 LD 4/WD (7.5 Only)	17124	07102	X		X			X			FF150974A	FR1525HD
	7,700 lb. G.V.W.R.			X		X			X			FF150974A	FR1525HD
1999 to 2004	F250 4WD	17162	Pgs. 72-73				X	X	X		X	FF350SD4B	FR350SDE
2000 to 2005	EXCURSION 4/WD	17162	07102	X	X							FF350SD4	FREXC4
2005 to 2007	F250 4/WD	17162	Pgs. 72-73				X	X	X		X	FF350SDC	FR250SDF
2008 and Later	F250 4/WD	17163	Pgs. 72-73				X	X	X		X	FF350SDC	FR250SDF
1999 to 2004	F350 4/WD	17162	Pgs. 72-73				X	X	X		X	FF350SD4B	FR350SDE
2005 to 2007	F350 4/WD	17162	Pgs. 72-73				X	X	X		X	FF350SDC	FR250SDF
1992 to 1998	F350 4800 FGAWR 4WD	17128	07102				X	X	X		X	FF3504A	FR350SDE
	DIESEL F350 5000 FGAWR 4WD						X	X	X		X	FF3504A	FR350SDE
2008 and Later	F350 4/WD	17163	Pgs. 72-73				X	X	X		X	FF350SDC	FR250SDF
1992 to 1998	F450 CAB CHASSIS 2/WD (8.5-9.5)	17128	07102				X	X	X		X	FFSD	FRSD
	15,000 lb. G.V.W.R.						X	X	X		X	FFSD	FRSD
1999 to 2004	F450 and F550 (8.5-10.0)	17162	Pgs. 72-73				X	X	X	X	X	FFSD4	FRSD
	CAB CHASSIS						X	X	X		X	FFSD4	FRSD
	2/WD and 4/WD						X	X	X		X	FFSD4	FRSD
2005 to 2007	F450 and F550 (8.5-10.0)	17162	Pgs. 72-73				X	X	X	X	X	FF550SDE	FRSD
	CAB CHASSIS						X	X	X		X	FF550SDE	FRSD
	2/WD and 4/WD						X	X	X		X	FF550SDE	FRSD
2008 and Later	F450 and F550 (8.5-10.0)	17163	Pgs. 72-73				X	X	X	X	X	FF550SDH	FRSD
	CAB CHASSIS						X	X	X		X	FF550SDH	FRSD
	2/WD and 4/WD						X	X	X		X	FF550SDH	FRSD
2006 to 2007	L45 / L55 (8.5-10.0)	17156	Pgs. 72-73				X	X	X	X	X	GMFW4C	BDLCFR
NEW MOUNTS													





Year	Vehicle	Mount #	Headlight Adapter	DP 7.6	STL	ST	C	LP	DE	HML	SV	Timbren	
HUMMER												Front	Rear
2003 to 2007	HUMMER H2	17143	07106	X	X							GMFK25S	GMRH2
NEW MOUNTS													

MOUNT SELECTION – EZ MOUNT PLUS (CONT.)

Year	Vehicle	Mount #	Headlight Adapter	DP 7.6	STL	ST	C	LP	DE	HML	SV	Timbren	
												Front	Rear
	HINO												
	2005 to 2007	HINO 145 / 165 / 185 (8.5-10.0)	17152	07180				X	X	X	X	X	HIF338
NEW MOUNTS													

Year	Vehicle	Mount #	Headlight Adapter	DP 7.6	STL	ST	C	LP	DE	HML	SV	Timbren	
												Front	Rear
	INTERNATIONAL												
	2006 to 2007	INTERNATIONAL CF 500 (8.5-10.0)	17156	07403				X	X	X	X	X	TOFTUN4
	INTERNATIONAL CF 600						X	X	X	X	X	TOFTUN4	URMDE
NEW MOUNTS													

Year	Vehicle	Mount #	Headlight Adapter	DP 7.6	STL	ST	C	LP	DE	HML	SV	Timbren		
												Front	Rear	
	MITSUBISHI FUSO FG													
	1998 to 2004	MITSUBISHI FUSO FG 4/WD (8.5-10.0)	17131	07101				X	X	X	X	X	MFFFG	MFRFG
	2005 to 2007	MITSUBISHI FUSO FG 4/WD (8.5-10.0)	17155	Pgs. 72-73				X	X	X	X	X	TORTUN4	MFRFG
NEW MOUNTS														

Year	Vehicle	Mount #	Headlight Adapter	DP 7.6	STL	ST	C	LP	DE	HML	SV	Timbren		
												Front	Rear	
	NISSAN													
	2004 to 2010	NISSAN TITAN	17151	07205	X	X							NF1004A	NRTTN
	2004 to 2010	NISSAN PATHFINDER ARMADA	17151	07205	X	X							NF1004A	NRARM
NEW MOUNTS														

Year	Vehicle	Mount #	Headlight Adapter	DP 7.6	STL	ST	C	LP	DE	HML	SV	Timbren		
												Front	Rear	
	TOYOTA													
	2000 to 2006	TOYOTA TUNDRA	17160	07180	X	X							TOFTUN4	TORTUN4
	2007 to 2010	TOYOTA TUNDRA	17167	07353	X	X							TOFTUN4	TORTUN4
NEW MOUNTS														

Year	Vehicle	Mount #	Headlight Adapter	DP 7.6	STL	ST	C	LP	DE	HML	SV	Timbren	
												Front	Rear
EXPORT TRUCKS ONLY													
1998 to 2004	MITSUBISHI CANTER (FG 4X4)	17131	07180					X	X		X	N/A	N/A
2005 to 2010	MITSUBISHI CANTER (FG 4X4)	17155	07180					X	X		X	N/A	N/A
2004 to 2010	NISSAN CAB STAR	17132	07635	X	X							N/A	N/A
2004 to 2010	NISSAN NAVARA/PATHFINDER/TITAN	17151	07635	X	X							N/A	N/A
NEW MOUNTS													

MOUNT SELECTION – DRIVE PRO 6'0" AND 6'8"



Year	Vehicle	Mount #	Headlight Adapter	DP	Timbren	
CHEVROLET/GMC					Front	Rear
2004 and Later	COLORADO	18504	07213	X	GMFC4	GMRCC
2004 and Later	CANYON	18504	07213	X	GMFC4	GMRCC
2002 and Later	TRAILBLAZER	18500	08143	X	N/A	N/A
1988 to 2000	K1500 PICKUP 4/WD	17119	Pgs. 72-73	X	GMFK35C	GMRCK25
1999 to 2002	K1500 PICKUP 4/WD	17140	07108	X	GMFK15A	GMRCK15S
2000 to 2002	K1500 YUKON / YUKON XL	17140	07108	X	GMFK15A	GMRCK15S
2000 to 2002	TAHOE / SUBURBAN 4/WD	17140	07108	X	GMFK15A	GMRCK15S
2001 to 2002	K1500 HD CREW CAB	17139	07108	X	GMFK25S	GMRCK25S
2003 to 2007	K1500 PICKUP 4/WD	17140	07400	X	GMFK15A	GMRCK15S
2003 to 2006	K1500 YUKON / YUKON XL	17140	07400	X	GMFK15A	GMRCK15S
2003 to 2007	K1500 HD CREW CAB	17165	07400	X	GMFK25S	GMRCK25S
2003 to 2006	TAHOE / SUBURBAN 4/WD	17140	07400	X	GMFK15A	GMRCK15S
2007 to 2010	K1500 YUKON / YUKON XL	17140	07334	X	GMFK15C	GMRCK15D
	WITHOUT VYU OPTION				GMFK15C	GMRCK15D
2007 to 2010	K1500 YUKON / YUKON XL	17165	07343	X	GMFK15C	GMRCK15D
	WITH VYU OPTION				GMFK15C	GMRCK15D
2007 to 2010	K1500 AVALANCHE	17165	07344	X	GMFK15C	GMRCK15D
2007 to 2010	K1500 PICKUP 4/WD	17165	07333	X	GMFK15C	GMRCK15D



Year	Vehicle	Mount #	Headlight Adapter	DP	Timbren	
DODGE					Front	Rear
2004 to 2010	DURANGO 4WD	17159	Pgs. 72-73	X	DDF974C	DDR05
2005 to 2010	DAKOTA 4WD	17159	Pgs. 72-73	X	DDF05A	DDR05
1994 to 2001	W1500 4WD	17123	Pgs. 72-73	X	DF25004B	DR1525H4
2002 to 2005	W1500 4WD	17130	Pgs. 72-73	X	DF15004C	DR2500CA
2006 to 2008	W1500 4WD	17130	Pgs. 72-73	X	DF15004B	DR1525H4
2009 and Later	W1500 4WD	17172	Pgs. 72-73	X	DF15004B	DR1500DS



Year	Vehicle	Mount #	Headlight Adapter	DP	Timbren	
FORD					Front	Rear
1998 and Later	RANGER	18505	07102	X	FXF1004	FRR0504A
2006 and Later	EXPLORER	18501	07417	X	N/A	N/A
2002 to 2005	EXPLORER	18508	07417	X	GMFK10	GMFK10
1992 to 1996	F150 PICKUP / BRONCO	17126	07102	X	FF1504H	FR250SDE
1997 to 1999	F150 PICKUP 4/WD	17124	07102	X	FF150974A	FR1525HD
2000 to 2003	F150 PICKUP 4/WD	17124	07102	X	FF150974A	FR1525HD
2004 to 2008	F150 PICKUP 4/WD	17141	07417	X	FF150974A	FR1525HD
2009 and Later	F150 PICKUP 4/WD	17171	07417	X	FF150F	FR1504D



Year	Vehicle	Mount #	Headlight Adapter	DP	Timbren	
HUMMER					Front	Rear
2003 to 2007	HUMMER H2	17143	07106	X	GMFK25S	GMRH2

MOUNT SELECTION – EZ MOUNT XPRESS



Year	Vehicle	Mount #	Headlight Adapter	AG	LP	DE	Timbren	
							Front	Rear
2000 to 2002	K2500 TAHOE / SUBURBAN 4/WD (7.5 Only)	17146	07108	X	X	X	GMFK25S	GMRSB4S
2000 to 2002	K2500 YUKON / YUKON XL 4/WD (7.5 Only)	17146	07108	X	X	X	GMFK25S	GMRSB4S
2002	K2500 AVALANCHE 4/WD (7.5 Only)	17146	07108	X	X	X	GMFK25S	GMRSB4S
2003 to 2010	K2500 TAHOE / SUBURBAN 4/WD (7.5 Only)	17146	07400	X	X	X	GMFK25S	GMRSB4S
2003 to 2010	K2500 AVALANCHE 4/WD (7.5 Only)	17146	07400	X	X	X	GMFK25S	GMRSB4S
2003 to 2007	K2500 YUKON / YUKON XL 4/WD (7.5 Only)	17146	07400	X	X	X	GMFK25S	GMRSB4S
2007 to 2010	K2500 YUKON / YUKON XL (7.5 Only)	17146	07334	X	X	X	GMFK25S	GMRSB4S
	WITHOUT VYU OPTION						GMFK25S	GMRSB4S
2007 to 2010	K2500 YUKON / YUKON XL (7.5 Only)	17146	07343	X	X	X	GMFK25S	GMRSB4S
	WITH VYU OPTION						GMFK25S	GMRSB4S
2007 to 2010	K2500 AVALANCHE (7.5 Only)	17146	07344	X	X	X	GMFK25S	GMRSB4S
	SUBURBAN 4/WD (7.5 Only)						GMFK25S	GMRSB4S
1999 to 2002	C/K2500 / K2500HD C/K3500 CHASSIS	17146	07108	X	X	X	GMFK25S	GMRCK25S
	NEW BODY STYLE						GMFK25S	GMRCK25S
2003 to 2007	C/K2500 / K2500HD	17146	07400	X	X	X	GMFK25S	GMRCK25S
	C/K3500 CHASSIS						GMFK25S	GMRCK25S
	NEW BODY STYLE						GMFK25S	GMRCK25S
2007 to 2010	K2500 / K2500/ K3500	17146	07333	X	X	X	GMFK25S	GMRCK25S
	K3500 CHASSIS						GMFK25S	GMRCK25S



Year	Vehicle	Mount #	Headlight Adapter	DP	DP	DP	Timbren	
							Front	Rear
1994 to 2002	W2500 4/WD	17149	07106	X	X	X	DF25004B	DR2500CA
2003 to 2010	W2500 4/WD	17148	07102	X	X	X	DF25004B	DR2500CA
1994 to 2002	W3500 4/WD	17149	07106	X	X	X	DF25004B	DR3500CA
2003 to 2010	W3500 4/WD	17148	07102	X	X	X	DF25004B	DR3500CA
2008 and Later	W4500 and W5500 4/WD	17169	Pgs. 72-73	X	X	X	DF5500HD	DRTT4500



Year	Vehicle	Mount #	Headlight Adapter	DP	DP	DP	Timbren	
							Front	Rear
1999 to 2004	F250 4WD	17145	Pgs. 72-73	X	X	X	FF350SD4B	FR350SDE
2005 to 2007	F250 4WD	17145	Pgs. 72-73	X	X	X	FF350SDC	FR250SDF
2008 and Later	F250 4/WD	17164	Pgs. 72-73	X	X	X	FF350SDC	FR250SDF
1999 to 2004	F350 4/WD	17145	Pgs. 72-73	X	X	X	FF350SD4B	FR350SDE
2005 to 2007	F350 4/WD	17145	Pgs. 72-73	X	X	X	FF350SDC	FR250SDF
2008 and Later	F350 4/WD	17164	Pgs. 72-73	X	X	X	FF350SDC	FR250SDF
1999 to 2004	F450 thru F550 4/WD	17145	Pgs. 72-73	X	X	X	FFSD4	FRSD
2005 to 2007	F450 thru F550 4/WD	17145	Pgs. 72-73	X	X	X	FF550SDE	FRSD
2008 and Later	F450 thru F550 4/WD	17164	Pgs. 72-73	X	X	X	FF550SDH	FRSDD

MOUNT SELECTION – EZ MOUNT CLASSIC



Year	Vehicle	Mount #	Headlight Adapter	TM	DP 6.8	DP 7.6	STL	ST	C	LP	HML	Timbren	
CHEVROLET/GMC												Front	Rear
1983 to 1994	S-BLAZER / S-JIMMY	18056	Pgs. 72-73	X								GMFS10	GMRS10A
1983 to 1994	S-BLAZER / S-JIMMY	18056DP	Pgs. 72-73		X							GMFS10	GMRS10A
1983 to 1993	S- PICK-UP 4/WD	18056	07180	X								GMFS10	GMRS10A
1983 to 1993	S- PICK-UP 4/WD	18056DP	07180		X							GMFS10	GMRS10A
1994	S- PICK-UP 4/WD	18078	07180	X								GMFS10	GMRS10A
1994	S- PICK-UP 4/WD	18078DP	07180		X							GMFS10	GMRS10A
1981 to 1987	K-10 (V-10), BLAZER	17091	Pgs. 72-73			X		X				GMFK10	GMRK10
1981 to 1991	JIMMY, SUBURBAN 4X4	17091	Pgs. 72-73			X		X				GMFK10	GMRK10
1988 to 2000	K1500 PICKUP 4/WD 1988 BODY	17089	Pgs. 72-73			X		X				GMFK35C	GMRCK25
1992 to 1994	BLAZER, JIMMY, SUBURBAN (7.5 Only)	17089	Pgs. 72-73			X		X	X			GMFK35C	GMRCK25
1999 to 2002	K1500 PICKUP 4/WD NEW BODY STYLE	17138	07108			X		X				GMFK15A	GMRCK15S
2001 to 2002	K1500 HD CREW CAB	17111	07108			X	X					GMFK25S	GMRCK25S
2000 to 2002	K1500 TAHOE / YUKON / SUBURBAN 4WD	17138	07108			X	X					GMFK15A	GMRCK15S
2003 to 2007	K1500 PICKUP 4/WD NEW BODY STYLE	17138	07400			X		X				GMFK15A	GMRCK15S
2003 to 2007	K1500 HD CREW CAB	17111	07400			X	X					GMFK25S	GMRCK25S
2003 to 2007	K1500 TAHOE / YUKON / SUBURBAN 4WD	17138	07400			X	X					GMFK15A	GMRCK15S
1981 to 1987	K-20 (V-20) PICKUP (7.5-8.0)	17091	Pgs. 72-73						X	X		GMFK10	GMRK10
1981 to 1991	K-20 SUBURBAN 4/WD (7.5-8.0)	17091	Pgs. 72-73						X	X		GMFK10	GMRK10
1981 to 1987	K-30 (V-30) PICKUP 4/WD	17091	Pgs. 72-73						X	X		GMFK10	GMRK30
1988 to 2000	K2500 and K3500 4/WD (1988 BODY STYLE)	17089	Pgs. 72-73						X	X		GMFK35C	GMRCK25
1988 to 2000	C2500 / C3500 2/WD	17094	Pgs. 72-73						X	X		GMFC1588H	GMRCK35
1999 to 2002	C2500 2/WD NEW BODY STYLE	17114	07108			X		X				GMFK25S	GMRCK25S
1999 to 2002	K2500 / K2500HD / K3500	17111	07108						X	X		GMFK25S	GMRCK25S
2000 to 2002	K2500 SUBURBAN YUKON XL 4WD	17111	07108			X		X				GMFK25S	GMRSB4S
2000 to 2002	K2500 AVALANCHE 4W/D	17111	07108			X		X				GMFK25S	GMRSB4S
2003 to 2010	K2500 SUBURBAN YUKON XL 4WD	17111	07400			X		X				GMFK25S	GMRSB4S
2003 to 2007	K2500 AVALANCHE 4W/D	17111	07400			X		X				GMFK25S	GMRSB4S
2003 to 2010	K2500 / K2500HD / K3500	17111	07400						X	X		GMFK25S	GMRCK25S
2003 to 2010	C2500/C3500 PICKUP 2/WD	17111	Pgs. 72-73						X	X		GMFK25S	GMRCK25S
1991 to 2002	HD 3500 2/WD (8.5 -10.0) 15000 GVWR	17093	Pgs. 72-73						X	X		GMF25HDA	GMR35HDM



Year	Vehicle	Mount #	Headlight Adapter	TM	DP 6.8	DP 7.6	STL	ST	C	LP	HML	Timbren	
DODGE												Front	Rear
THRU 1996	DAKOTA 4/WD	18060	Pgs. 72-73	X								DDF1004	DDR1004
THRU 1996	DAKOTA 4/WD	18060DP	Pgs. 72-73		X							DDF1004	DDR1004
1972 to 1993	W150 / RAMCHARGER 4WD	17090	07180			X		X				DF3504BA	DR150
1994 to 1996	W1500 4/WD	17103	07106			X		X				DF25004B	DR1525H4
1997 to 2001	W1500 4/WD	17103	07106			X	X					DF25004B	DR1525H4
1999 to 2001	W1500 SPORT 4/WD	17116	07221			X	X					DF15004C	DR2500CA
1972 to 1993	W250 4/WD (7.5 Only) 4000 FAGWR	17090	07180						X	X		DF3504BA	DR250
1972 to 1993	W250 / W350 4/WD 4500 FGAWR	17099	07180						X	X		DF3504BA	DR3502
1994 to 2002	W2500, W3500, CAB CHASSIS 4/WD	17104	07106						X	X		DF25004B	DR1525H4
1999 to 2002	W2500 SPORT 4/WD (7.5-8.0)	17117	07221						X	X		DF25004B	DR1525H4
2003 to 2010	W2500, W3500 CAB CHASSIS HD 4/WD	17135	Pgs. 72-73						X	X		DF25004B	DR3500CA

MOUNT SELECTION – EZ MOUNT CLASSIC (CONT.)



Year	Vehicle	Mount #	Headlight Adapter	TM	DP 6.8	DP 7.6	STL	ST	C	LP	HML	Timbren	
FORD												Front	Rear
THRU 1989	BRONCO II / RANGER 4/WD	18058	Pgs. 72-73	X								FXF1004	FRR0504A
THRU 1989	BRONCO II / RANGER 4/WD	18058DP	Pgs. 72-73		X							FXF1004	FRR0504A
1987 to 1991	F100 / F150 / BRONCO 3800 FGAWR 4WD	17096	07106			X		X				FF1504H	FR250SDE
1992 to 1996	F150 PICKUP / BRONCO 4/WD	17097	07102			X		X				FF1504H	FR250SDE
1992	BRONCO 4/WD					X		X				FF1504H	FAR001
1997 to 1999	F150 PICKUP 4/WD	17108	07102			X	X					FF150974A	FR1525HD
2000 to 2003	F150 PICKUP 4/WD 7700 GVWR	17108	07102			X		X				FF150974A	FR1525HD
1987 to 1991	F250 and F350 PICKUP 4/WD 4600 FGAWR	17092	07106						X	X		FF2504	FR250SDE
	DIESEL F350 5000 FGAWR								X	X		FF2504	FR250SDE
1992 to 1998	F250 4/WD 4600 FGAWR	17098	07102						X	X		FF2504A	FR250SDE
1997 to 1999	F250 LD 4/WD 7700 GVWR	17108	07102			X		X				FF150974A	FR1525HD
1999 to 2005	EXCURSION 4/WD	17112	07102			X	X					FF350SD4	FREXC4
1999 to 2004	F250 PICKUP 2/WD	17115	07102			X	X					FF350SD2	FR250SDE
1999 to 2004	F250 SUPERDUTY 5200 FGAWR	17112	07102						X	X		FF350SD4B	FR350SDE
1999 to 2004	F250 SUPERDUTY 6000 FGAWR	17113	07102						X	X		FF350SD4B	FR350SDE
1992 to 1998	F350 4/WD 4800 FGAWR	17095	07102						X	X		FF3504A	FR350SDE
1992 to 1998	F350, CAB CHASSIS 5000 FGAWR 4/WD	17106	07102						X	X		FF3504A	FR350SDE
1999 to 2004	F350 SUPERDUTY 5200 FGAWR	17112	07102						X	X		FF350SD4B	FR350SDE
1999 to 2004	F350 SUPERDUTY 6000 FGAWR	17113	07102						X	X		FF350SD4B	FR350SDE
1999 to 2004	F350 (7.5-8.0) 2WD	17115	07102						X	X		FF350SD2	FR250SDE
1988 to 1991	F450 CAB CHASSIS 2/WD (8.5-9.0)	17096	07106						X	X		FFSD	FRSD
	15,000 lb. G.V.W.R.								X	X		FFSD	FRSD
1992 to 1998	F450 CAB CHASSIS 2/WD (8.5-9.0)	17105	07102						X	X		FFSD	FRSD
	15,000 lb. G.V.W.R.								X	X		FFSD	FRSD
1999 to 2004	F450 and F550 SUPERDUTY (8.5-9.0)	17113	07102						X	X		FFSD4	FRSD
	CAB CHASSIS 2WD and 4/WD								X	X		FFSD4	FRSD

HUMMER

Year	Vehicle	Mount #	Headlight Adapter	TM	DP 6.8	DP 7.6	STL	ST	C	LP	HML	Timbren	
HUMMER												Front	Rear
1993 to 2007	HUMMER H1 (8.0-10.0)	17109	07180						X	X	X	N/A	N/A

Jeep

Year	Vehicle	Mount #	Headlight Adapter	TM	DP 6.8	DP 7.6	STL	ST	C	LP	HML	Timbren	
JEEP												Front	Rear
1984 to 1996	XJ WAGONEER CHEROKEE 4WD	18062	07180	X								JFC01	JRC01
1997 to 2002	CHEROKEE 4/WD	18084	07180	X								JFC01	JRC01
1997 to 2002	CHEROKEE 4/WD	18084DP	07180		X							JFC01	JRC01
1997 to 2006	TJ WRANGLER	18080	07180	X								JFTJ	JFTJ
1997 to 2006	TJ WRANGLER	18080DP	07180		X							JFTJ	JFTJ
2007 and Later	JK WRANGLER	18119	07417	X								JFJK	JRJK
2007 and Later	JK WRANGLER	18119DP	07417		X							JFJK	JRJK

MOUNT SELECTION – CUSTOM



Year	Vehicle	Mount #	Headlight Adapter	TM	DP 7.6	ST	C	LP	DE	HM	RP	Timbren	
												Front	Rear
CHEVROLET/GMC													
1973 to 1987	K-10 (V-10) PICKUP 4/WD	17078	Pgs. 72-73			X						GMFK10	GMRK10
1973 to 1991	K-5 BLAZER, JIMMY,	17078	Pgs. 72-73			X						GMFK10	GMRK10
1973 to 1991	K-10 SUBURBAN 4/WD	17078	Pgs. 72-73			X						GMFK10	GMRK10
1973 to 1987	K-20 (V-20) PICKUP (7.5-8.0)	17078	Pgs. 72-73				X					GMFK10	GMRK10
1973 to 1991	K-20 SUBURBAN 4/WD (7.5-8.0)	17078	Pgs. 72-73				X					GMFK10	GMRK10
1973 to 1987	K-30 (V-30) PICKUP 4/WD	17078	Pgs. 72-73				X					GMFK10	GMRK30
1996 to 2005	W3500 / W4500 / W5500	17107	Pgs. 72-73			X						GMFW4C	GMRW55
2003 to 2010	C4500 / C5500 2/WD (18000-19000 GVWR)	17133	Pgs. 72-73							X		GMFTK	GMRTKM
2003 to 2010	C4500 / C5500 2/WD (9.0-10.0) (16000 GVWR)	17133	Pgs. 72-73				X					GMFTK	GMRTKM
2005 to 2010	C4500 / C5500 4/WD (18000-26000 GVWR)	17153	Pgs. 72-73							X		GMF55AWD	GMRTKM
2005 to 2010	C4500 / C5500 4/WD (9.0-10.0) (16000 GVWR)	17153	Pgs. 72-73				X					GMF55AWD	GMRTKM



Year	Vehicle	Mount #	Headlight Adapter	TM	DP 7.6	ST	C	LP	DE	HM	RP	Timbren	
												Front	Rear
FORD													
1984 to 1991	F150 PICKUP 4/WD 3800 FGAWR	17081	Pgs. 72-73			X							FF1504H
1984 to 1991	F250 and F350 PICKUP 4/WD 4600 FGAWR	17081	Pgs. 72-73				X						FF2504
	DIESEL F350 5000 FGAWR						X						FF2504
2003 to 2007	F650 /F750	17154	Pgs. 72-73								X		HSR001
2008 and Later	F650 /F750	17170	Pgs. 72-73								X		HSR001



Year	Vehicle	Mount #	Headlight Adapter	TM	DP 7.6	ST	C	LP	DE	HM	RP	Timbren	
												Front	Rear
INTERNATIONAL													
2003 to 2007	INTERNATIONAL 4200/4300/4400	17154	07403								X		IHF4000N



Year	Vehicle	Mount #	Headlight Adapter	TM	DP 7.6	ST	C	LP	DE	HM	RP	Timbren	
												Front	Rear
ISUZU													
1996 to 2007	ISUZU NPR CAB CHASSIS	17107	07101			X							TORTUN4



Year	Vehicle	Mount #	Headlight Adapter	TM	DP 7.6	ST	C	LP	DE	HM	RP	Timbren	
												Front	Rear
JEEP													
1972 to 1986	CJ 5,6,7 /SCRAMBLER 4/WD	17000	07180			X							JFCJ1
1987 to 1996	YJ WRANGLER 4/WD	17082	07180			X							JFYJ1

MOUNT SELECTION – CUSTOM (CONT.)

Year	Vehicle	Mount #	Headlight Adapter	TM	DP 7.6	ST	C	LP	DE	HM	RP	Timbren	
ROAD PRO												Front	Rear
ALL	BUMPER TO FRAME 27-33000 GWW	16522	Pgs. 72-73								X	N/A	N/A

Year	Vehicle	Mount #	Headlight Adapter	TM	DP 7.6	ST	C	LP	DE	HM	RP	Timbren	
HEAVY MUNICIPAL BUMPER TO FRAME (HM SERIES)												Front	Rear
ALL	BUMPER TO FRAME (17500-27000 GWW)	16486	Pgs. 72-73							X		N/A	N/A

Year	Vehicle	Mount #	Headlight Adapter	TM	DP 7.6	ST	C	LP	DE	HM	RP	Timbren	
HEAVY MUNICIPAL BUMPER TO AXLE (HM SERIES)												Front	Rear
ALL	BUMPER TO AXLE (17500-27000 GWW)	16500	Pgs. 72-73							X		N/A	N/A

Year	Vehicle	Mount #	Headlight Adapter	TM	DP 6.0, 6.8, 7.6	ST	C	LP	DE	HM	RP	Timbren	
SKIDSTEER												Front	Rear
	SMALL SKID STEER TRACTOR (uses DP/PLUS/PAF)	13680	N/A		X			X	X			N/A	N/A
SKIDSTEER	UNIVERSAL MOUNT SYSTEM	17166	N/A						X			N/A	N/A

Year	Vehicle	Mount #	Headlight Adapter	TM	DP 6.0, 6.8, 7.6	ST	C	LP	DE	HM	RP	Timbren	
TRACTOR - SMALL - LIGHT MEDIUM												Front	Rear
B SERIES	TRACTORS - SMALL	17161	N/A	X								N/A	N/A
ALL	BX KUBOTA (uses DP/PLUS/PAF)	13680	N/A		X			X	X			N/A	N/A

Year	Vehicle	Mount #	Headlight Adapter	TM	DP 7.6	ST	C	LP	DE	HM	RP	Timbren	
HEAVY ADJUSTABLE UTILITY TRACTOR (H.A.T.)												Front	Rear
ALL	TRACTORS WITH FULL FRAMES	16305	Pgs. 72-73			X	X	X	X			N/A	N/A

Year	Vehicle	Mount #	Headlight Adapter	TM	DP 7.6	ST	C	LP	DE	HM	RP	Timbren	
AIRPORT TRACTORS												Front	Rear
ALL	TUG/HARLAN	18109	Pgs. 72-73			X						N/A	N/A
ALL	TUG/HARLAN	18109DP	Pgs. 72-73		X	X						N/A	N/A

Year	Vehicle	Mount #	Headlight Adapter	TM	DP 7.6	ST	C	LP	DE	HM	RP	Timbren	
UNIVERSAL BUMPER TO FRAME (U.B.F.)												Front	Rear
ALL	BUMPER TO FRAME (7.5-8.5)	17056	Pgs. 72-73			X	X					N/A	N/A
	MEDIUM DUTY PICKUP 6600-10000 GWW											N/A	N/A

DRIVE PRO™ – PERSONAL/CONTRACTOR PLOW (FITS 1/2 TON, LIGHT TRUCK AND SUV VEHICLES)

Meyer® DRIVE PRO™



*Drive Pro 7' 6" Poly
Moldboard Back*



*Drive Pro 6' 8" Steel
Moldboard Front*



*Drive Pro 6' 8" Steel
Moldboard Back*

PLOWS/
ACCESSORIES

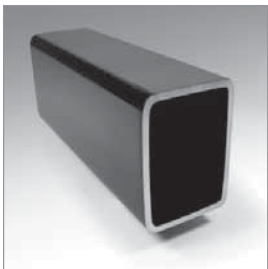

Tubular Push Frame

Municipally inspired push frames are designed to provide maximum strength and support for the moldboard across the entire back of the plow utilizing a heavy-duty tubular frame and reinforcement bar. They attach at two points to reduce load pressure when plowing.



Heavy-Duty Trip Springs

Heavier gauge and more efficient design yield the longest service life in the industry.



Heavy-Duty King Bolt

Heavy-Duty King Bolt is reinforced for maximum durability.

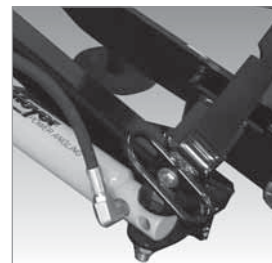

Single Handle – 6' 0" and 6' 8" Plows

Easily remove the plow from your vehicle by pulling one handle and disconnect the one-piece plug for a clean, neat appearance for the front of your vehicle.

DRIVE PRO™ – PERSONAL/CONTRACTOR PLOW (FITS 1/2 TON, LIGHT TRUCK AND SUV VEHICLES)

Drive Pro 6'0"/6'8" Product Specifications

Model #	Mounting Type	Blade Type	Moldboard Length	Moldboard Height	Moldboard Gauge	Vertical Ribs	Plow Trip Springs	Cutting Edge	Average Width at Full Angle	Angling Rams	Weight† Complete
DP-5.0	Drive Pro	Full-Trip	5' 0"	22.5"	14 Steel	6	2	1/4" x 6"	54.5"	1 1/2" x 10"	330 lb
DP-6.0	Drive Pro	Full-Trip	6' 0"	22.5"	14 Steel	6	2	1/4" x 6"	65"	1 1/2" x 10"	350 lb
DP-6.8	Drive Pro	Full-Trip	6' 8"	22.5"	14 Steel	6	2	1/4" x 6"	72"	1 1/2" x 10"	375 lb

† Weight without mount and clevis.

Drive Pro 6'0"/6'8" Moldboard and Accessories

PART NO.	DESCRIPTION	CUTTING EDGES			DEFLECTORS			CURB GUARDS	HYDRAULIC LOCK	REPLACEABLE SHOES
		Steel	Rubber	Urethane	Molded	Rubber	Poly			
09320	DP 5.0 STEEL	08172*	N/A	N/A	N/A	08238	N/A	N/A	07695C	09127*
09270	DP 6.0 STEEL	08175*	08237	08116	12036	08103	N/A	N/A	07695C	09127*
09274	DP 6.8 STEEL	08176*	08236	08277	13071	08107	N/A	N/A	07695C	09127*

* Included with moldboard

Lift Frame		PAF/SAF Carton		Hydraulic Unit <small>ONLY ORDER 1</small>		Plow Lights <small>ONLY ORDER 1</small>	
PART NO.	DESCRIPTION	PART NO.	DESCRIPTION	PART NO.	DESCRIPTION	PART NO.	DESCRIPTION
16601	CLF DRIVE PRO	16600	PAF DRIVE PRO	15988	E-58H 12V HYD CTN	07234	NITE SABER I
16604	CLF PLUS	16600	PAF DRIVE PRO	15602	E-58H 24V HYD CTN	07550	NITE SABER II
						07404	EURO 24V

Drive Pro 7'6" Product Specifications

Model #	Mounting Type	Blade Type	Moldboard Length	Moldboard Height	Moldboard Gauge	Vertical Ribs	Plow Trip Springs	Cutting Edge	Average Width at Full Angle	Angling Rams	Weight† Complete
DP-7.6	Drive Pro	Full-Trip	7' 6"	28"	14 Steel	6	2	3/8" x 6"	81"	1 1/2" x 10"	575 lb.
DPP-7.6	Drive Pro	Full-Trip	7' 6"	28"	3/8 Poly	6	2	3/8" x 6"	81"	1 1/2" x 10"	620 lb.

† Weight without mount and clevis.

Drive Pro 7'6" Moldboard and Accessories

PART NO.	DESCRIPTION	CUTTING EDGES			DEFLECTORS			CURB GUARDS	HYDRAULIC LOCK	REPLACEABLE SHOES
		Steel	Rubber	Urethane	Molded	Rubber	Poly			
09275	DP 7.6 STEEL	08178*	08189	09224	12039	08109	12078	08344	07695C	09127*
09278	DPP 7.6 POLY	08178*	08189	09224	12039	08109	12078*	08344	07695C	09127*

* Included with moldboard

Lift Frame		PAF/SAF Carton		Hydraulic Unit <small>ONLY ORDER 1</small>		Plow Lights <small>ONLY ORDER 1</small>	
PART NO.	DESCRIPTION	PART NO.	DESCRIPTION	PART NO.	DESCRIPTION	PART NO.	DESCRIPTION
16531	CLF PLUS	16546	PAF PLUS MOUNT	15988	E-58H 12V HYD CTN	07234	NITE SABER I
11255	LF CLASSIC	16548	PAF CLASSIC MOUNT	15602	E-58H 24V HYD CTN	07550	NITE SABER II
	Included in 16556	16556	PAF HAT/TUG	08878	CENTRAL HYD KIT	07404	EURO 24V

LOT PRO™ – CONTRACTOR PLOW (FITS 3/4 TON+ VEHICLES)

PLOWS/
ACCESSORIES

Meyer
LOT PRO™



Lot Pro Poly Moldboard Front

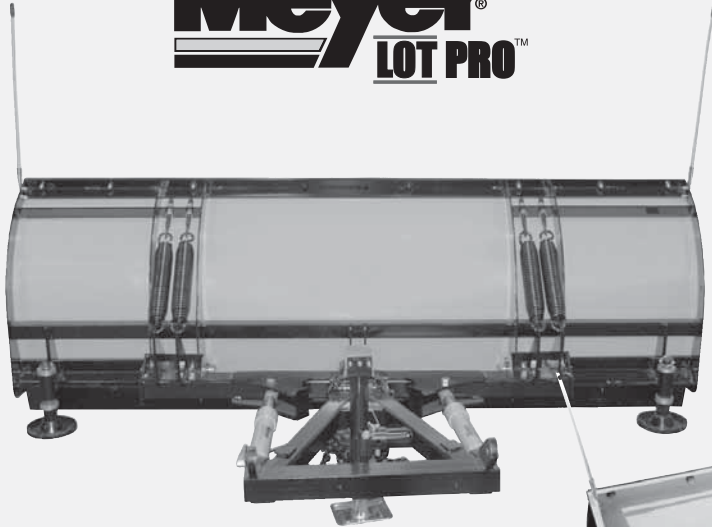

Lot Pro Poly Moldboard Back

Lot Pro Steel Moldboard Back

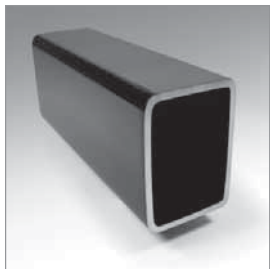

Tubular Push Frame

Municipally inspired push frames are designed to provide maximum strength and support for the moldboard across the entire back of the plow utilizing a heavy-duty tubular frame and reinforcement bar. They attach at three points to reduce load pressure when plowing.



Heavy-Duty King Bolt

Heavy-Duty 1" King Bolt is greaseable and reinforced for maximum durability.



Greaseable Pivot/ Mounting Pins

Features greaseable connections at critical pivot and mounting points for longer service life.



Accessory Mounting Holes

Moldboards feature pre-drilled mounting holes to make it quick and easy to add accessories like deflectors and wings.



Mushroom Shoes

Designed to glide over unexpected potholes or manhole covers when plowing.

LOT PRO™ – CONTRACTOR PLOW (FITS 3/4+ TON VEHICLES)

Lot Pro Product Specifications

Model #	Mounting Type	Blade Type	Moldboard Length	Moldboard Height	Moldboard Gauge	Vertical Ribs	Plow Trip Springs	Cutting Edge	Average Width at Full Angle	Angling Rams	Weight† Complete
LP-7.5	Classic/Plus/Xpress	Full-Trip	7' 6"	32"	12 Steel	6	4	3/8" x 6"	81"	1 1/2" x 10"	773 lb
LP-8.0	Classic/Plus/Xpress	Full-Trip	8' 0"	32"	12 Steel	6	4	1/2" x 6"	86"	1 1/2" x 10"	820 lb.
LP-8.5	Classic/Plus/Xpress	Full-Trip	8' 6"	32"	12 Steel	6	4	1/2" x 6"	92"	1 1/2" x 10"	835 lb.
LP-9.0	Classic/Plus/Xpress	Full-Trip	9' 0"	32"	12 Steel	6	4	1/2" x 6"	97"	1 1/2" x 10"	843 lb.
LPP-7.5	Classic/Plus/Xpress	Full-Trip	7' 6"	32"	3/8" Poly	6	4	3/8" x 6"	81"	1 1/2" x 10"	893 lb.
LPP-8.0	Classic/Plus/Xpress	Full-Trip	8' 0"	32"	3/8" Poly	6	4	1/2" x 6"	86"	1 1/2" x 10"	912 lb.
LPP-8.5	Classic/Plus/Xpress	Full-Trip	8' 6"	32"	3/8" Poly	6	4	1/2" x 6"	92"	1 1/2" x 10"	932 lb.
LPP-9.0	Classic/Plus/Xpress	Full-Trip	9' 0"	32"	3/8" Poly	6	4	1/2" x 6"	97"	1 1/2" x 10"	943 lb.
LP-10.0*	Classic/Plus/Xpress	Full-Trip	10' 0"	32"	10 Steel	6	6	1/2" x 6"	103"	2" x 10"	943 lb.

† Average mount weight is 125 lbs.

* Fits 16,500-20,000 GVW vehicles

Lot Pro Moldboard and Accessories

PART NO.	DESCRIPTION	CUTTING EDGES			DEFLECTORS			CURB GUARDS	ADJ. WINGS	BOX WINGS	FIXED WINGS
		Steel	Rubber	Urethane	Molded	Rubber	Poly				
09400	LP 7.5 STEEL	08178*	08189	08119	12039	08109	12078	08344	08105	08104	08100
09401	LP 8.0 STEEL	08180*	08190	08160	12040	08111	12024	08344	08105	08104	08100
09402	LP 8.5 STEEL	08182*	08191	08162	12041	08112	12025	08344	08105	08104	08100
09403	LP 9.0 STEEL	08185*	08192	08164	12042	08113	12123	08344	08105	08104	08100
09404	LPP 7.5 POLY	08178*	08189	08119	12039	08109	12078*	08344	08115	08104	08110
09405	LPP 8.0 POLY	08180*	08190	08160	12040	08111	12024*	08344	08115	08104	08110
09406	LPP 8.5 POLY	08182*	08191	08162	12041	08112	12025*	08344	08115	08104	08110
09407	LPP 9.0 POLY	08185*	08192	08164	12042	08113	12123*	08344	08115	08104	08110
09408	LP 10.0 STEEL	08216*	08193	08167	12043	08114	12124	09344	08105	08104	08100

*Included with moldboard

Lift Frame		PAF/SAF Carton		Hydraulic Unit <small>ONLY ORDER 1</small>		Plow Lights** <small>ONLY ORDER 1</small>	
PART NO.	DESCRIPTION	PART NO.	DESCRIPTION	PART NO.	DESCRIPTION	PART NO.	DESCRIPTION
16531	CLF PLUS	16547	PAF PLUS MOUNT	15988 15602 08878	E-58H 12V HYD CTN E-58H 24V HYD CTN CENTRAL HYD KIT	07234 07550 07404	NITE SABER I NITE SABER II NITE SABER EURO 24V
11255	LF CLASSIC	16549	PAF CLASSIC MOUNT				
16531	CLF PLUS	16552	PAF PLUS MOUNT LP 10.0				
11255	LF CLASSIC	16553	PAF CLASSIC MOUNT LP 10.0				
Not Required		16557	PAF HAT MOUNT				
19170	LF XPRESS	16551	PAF XPRESS MOUNT	15820	E-68		

** Requires fender mounting light bracket #19168 if custom mount (2 required)

ROAD PRO™ – CONTRACTOR PLOW (FITS 23,000-33,000 GVW)

Meyer® ROAD PRO™



**Road Pro Poly
Moldboard Back**



Road Pro Poly Moldboard Front



**Road Pro Steel
Moldboard Back**

PLOWS/
ACCESSORIES



Road Ready Push Frames

All Road Pro moldboards feature eight vertical ribs and a massive black iron push frame to provide the strength needed to clean city streets and small rural neighborhoods.



Pivot Bolt

The Road Pro moldboard is designed to operate in either a fixed position or to pivot five degrees on each side to follow the contour of the road so more snow can be cleared in less time.



E-70 Power Option

Designed to be easily installed to fit a wide variety of municipal vehicles. Perfect for landscapers and contractors who want to add a plow to vehicles that do not have central hydraulics. Part #15825



Adjustable Shoes (optional)

Shoes are constructed from formed heavy-duty cast iron. Mushroom design helps during backdragging operations. Can be easily adjusted with single handle crank. Wear disc is designed to protect the shoe from damage. Part #09295 (Kit) Part #19056 Wear Disc (replaceable)

ROAD PRO™ – CONTRACTOR PLOW (FITS 23,000-33,000 GVW)

Road Pro Product Specifications											
Model #	Mounting Type	Blade Type	Moldboard Length	Moldboard Height	Moldboard Gauge	Vertical Ribs	Plow Trip Springs	Cutting Edge	Average Width at Full Angle	Angling Rams	Weight† Complete
RP-9	Custom	Full-Trip	9' 0"	36"	10 Steel	8	6	1/2" x 6"	93"	2 1/2" x 11 1/2"	1562 lb
RP-10	Custom	Full-Trip	10' 0"	36"	10 Steel	8	6	1/2" x 6"	104"	2 1/2" x 11 1/2"	1610 lb.
RP-11	Custom	Full-Trip	11' 0"	36"	10 Steel	8	6	3/4" x 6"	114"	2 1/2" x 11 1/2"	1660 lb.
RPP-10	Custom	Full-Trip	10' 0"	36"	3/8" Poly	8	6	1/2" x 6"	104"	2 1/2" x 11 1/2"	1590 lb.
RPP-11	Custom	Full-Trip	11' 0"	36"	3/8" Poly	8	6	3/4" x 6"	114"	2 1/2" x 11 1/2"	1640 lb.
RPDE-10	Custom	Bottom-Trip	10' 0"	36"	10 Steel	8	8	1/2" x 6"	104"	2 1/2" x 11 1/2"	1850 lb.

† Weight without options.

Road Pro Moldboard and Accessories											
PART NO.	DESCRIPTION	CUTTING EDGES				DEFLECTORS			CURB GUARDS	SNOW SHOE	REPLACEMENT WEARABLE SHOE
		Steel	Rubber	Urethane	Carbide	Molded	Rubber	Poly			
09299	RP 9.0 STEEL	08185*	08192	08164	N/A	12042	08113	12123	08344	09295	19056
09287	RP 10.0 STEEL	08216*	08193	08167	08780	12043	08114	12124	08344	09295	19056
09288	RPP 10.0 POLY	08216*	08193	08167	08780	12043	08114	12124*	08344	09295	19056
84200	RPDE 10.0 STEEL	08195*	N/A	08169	N/A	N/A	N/A	N/A	08344	09295	19056
09290	RP 11.0 STEEL	08217*	N/A	08168	08781	N/A	N/A	N/A	08344	09295	19056
09291	RPP 11.0 POLY	08217*	N/A	08168	08781	N/A	N/A	N/A	08344	09295	19056

* Included with moldboard

Pivot Bar		PAF/SAF Carton		Hydraulic Unit <small>ONLY ORDER 1</small>		Plow Lights** <small>ONLY ORDER 1</small>	
PART NO.	DESCRIPTION	PART NO.	DESCRIPTION	PART NO.	DESCRIPTION	PART NO.	DESCRIPTION
12300	RP SERIES	16521	SAF RP SERIES	15825	E-70 12V HYD CTN	07234	NITE SABER I
81027	RPDE SERIES	81505	SAF RPDE SERIES	15853	CENTRAL HYD KIT	07550	NITE SABER II
						07404	EURO 24V

** Requires fender mounting light bracket #19168 if custom mount (2 required)

NOTES

DIAMOND EDGE – CONTRACTOR PLOW (FITS 3/4 TON+ VEHICLES)



*Diamond Edge
Moldboard Front*



*Diamond Edge Steel
Moldboard Back*

PLOWS/
ACCESSORIES

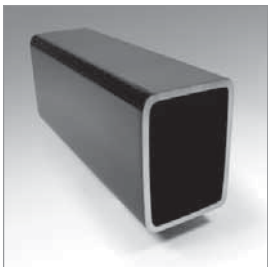

Tubular Push Frame

Municipally inspired push frames are designed to provide maximum strength and support for the moldboard utilizing a heavy-duty tubular frame and reinforcement bar.



Center Punched Replaceable Cutting Edges – Standard

Standard feature allows the cutting edge to be removed, turned 180 degrees and reattached to the moldboard, doubling the life of the cutting edge.



Trip Edge Mounting Pin Diameter

Heavy-duty pin is larger than competitive models and is easily removed during maintenance operations.



Easy To Adjust/ Replaceable Trip Springs

Diamond Edge plows feature field adjustable springs that do not require any special tools and can be modified in minutes as conditions change.

DIAMOND EDGE – CONTRACTOR PLOW (FITS 3/4 TON+ VEHICLES)

Diamond Edge Product Specifications

Model #	Mounting Type	Blade Type	Moldboard Length	Moldboard Height	Moldboard Gauge	Vertical Ribs	Plow Trip Springs	Cutting Edge	Average Width at Full Angle	Angling Rams	Weight† Complete
DE-7.5	EZ-Plus / Xpress	Bottom-Trip	7' 6"	31.5"	12 Steel	6	4	1/2" x 6"	78"	1 1/2" x 10"	805 lb
DE-8.0	EZ-Plus / Xpress	Bottom-Trip	8' 0"	31.5"	12 Steel	6	4	1/2" x 6"	83"	1 1/2" x 10"	840 lb.
DE-8.5	EZ-Plus / Xpress	Bottom-Trip	8' 6"	31.5"	12 Steel	6	4	1/2" x 6"	88"	1 1/2" x 10"	870 lb.
DE-9.0	EZ-Plus / Xpress	Bottom-Trip	9' 0"	31.5"	12 Steel	6	4	1/2" x 6"	94"	1 1/2" x 10"	890 lb.

† Weight without options.

Diamond Edge Moldboard and Accessories

PART NO.	DESCRIPTION	CUTTING EDGES			DEFLECTORS			CURB GUARDS	HYDRAULIC LOCK
		Steel	Rubber	Urethane	Molded	Rubber	Poly		
84250	DE 7.5 STEEL	08179*	08218	08159	12039	08109	12078	08344	07695C
84251	DE 8.0 STEEL	08181*	08219	08161	12040	08111	12024	08344	07695C
84252	DE 8.5 STEEL	08183*	08220	08163	12041	08112	12025	08344	07695C
84253	DE 9.0 STEEL	08215*	08221	08165	12042	08113	12123	08344	07695C

* Included with moldboard

Lift Frame		PAF/SAF Carton		Hydraulic Unit <small>ONLY ORDER 1</small>		Plow Lights <small>ONLY ORDER 1</small>	
PART NO.	DESCRIPTION	PART NO.	DESCRIPTION	PART NO.	DESCRIPTION	PART NO.	DESCRIPTION
16531	CLF PLUS	16544	SAF PLUS MOUNT	15988	E-58H 12V HYD CTN	07234 07550 07404	NITE SABER I NITE SABER II EURO 24V
				15602	E-58H 24V HYD CTN		
				08878	CENTRAL HYD KIT		
19170	LF XPRESS	16545	PAF XPRESS MOUNT	15820†	E-68 12V HYD CTN		
		16558	PAF HAT MOUNT				

† 15820 Xpress Only

NOTES

SUPER-V – CONTRACTOR PLOW (FITS 3/4 TON+ VEHICLES)

Meyer[®] SUPER-V

Super-V2 Moldboard Front



*Super-V2 Steel
Moldboard Back*

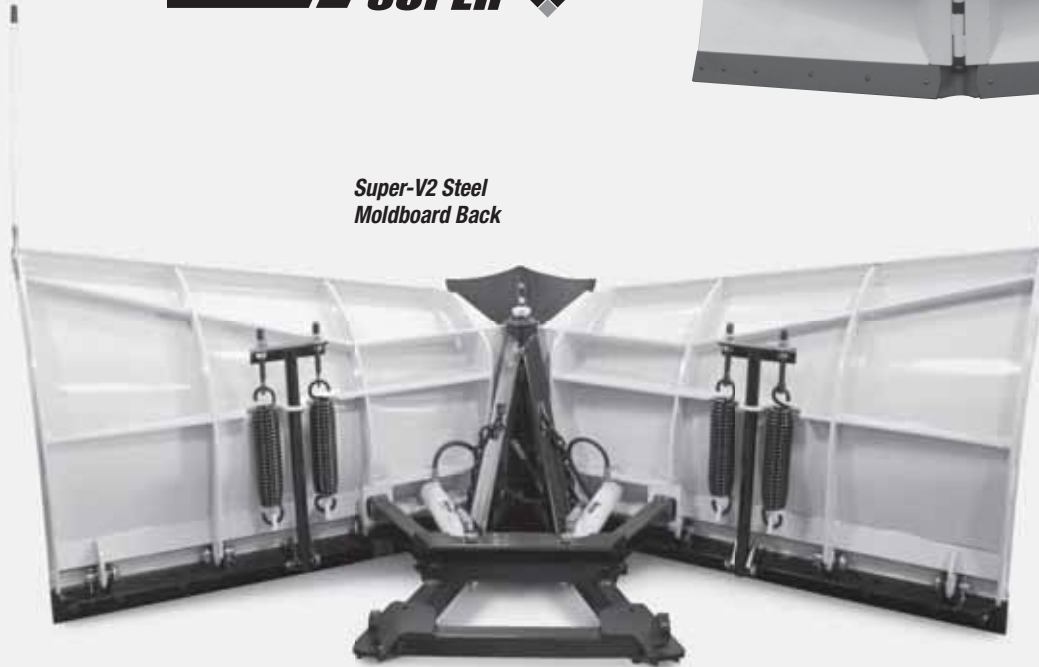

Tapered Wings

Our Super-V2 plow features a tapered wing design that can move snow up to 62% better than conventional v-plows.

Locked and Ready for Action

Why pay for a lock-out system when you don't have to? Backdrag snow more efficiently than ever with our standard locking, double-acting cylinders. Going forward or backward, just set the angle you want and the blade position is locked.



Scoop Mode



V Mode



Straight Mode



Tower Section and Wing Stop Supports

Engineered to absorb daily impact during plowing operations. Increases cylinder and plow life, while dissipating the effects on drivers.



Bottom-trip Blades

All Meyer V-Plow blades feature bottom-trip wings that trip independently in any plow configuration, something the competition can't match.



Single Button Controller Functions

Standard on Meyer V-Plows, our exclusive one button controller lets you put the plow in V, scoop or straight configurations with just one push. It can also be used with all newer Meyer straight blade plows.

SUPER-V – CONTRACTOR PLOW (FITS 3/4 TON+ VEHICLES)

Super-V Product Specifications

Model #	Mounting Type	Blade Type	Moldboard Length	Moldboard Height	Moldboard Gauge	Vertical Ribs	Plow Trip Springs	Cutting Edge	Angling Rams	Weight † Complete
SV-8.5	EZ-Plus	Bottom-Trip	8' 6"	30.5"	12 Steel	4/wing	2/wing	1/2" x 6"	1 1/2" x 12"	900 lb
SV-9.5	EZ-Plus	Bottom-Trip	9' 6"	30.5"	12 Steel	4/wing	2/wing	1/2" x 6"	1 1/2" x 12"	940 lb.
SV2-8.5	EZ-Plus	Bottom-Trip	8' 6"	29.5"–38.25"*	12 Steel	4/wing	2/wing	1/2" x 6"	1 1/2" x 12"	954 lb.
SV2-9.5	EZ-Plus	Bottom-Trip	9' 6"	29.5"–39.5"*	12 Steel	4/wing	2/wing	1/2" x 6"	1 1/2" x 12"	994 lb.
SV2-10.5	EZ-Plus	Bottom-Trip	10' 6"	29.5"–40.5"*	12 Steel	4/wing	2/wing	1/2" x 6"	1 1/2" x 12"	1034 lb.

* Height from the center of moldboard to each end

† Weight without mount

Super-V Moldboard and Accessories

PART NO.	DESCRIPTION	RUBBER DEFLECTORS	STEEL CUTTING EDGES	URETHANE CUTTING EDGES	CURB GUARDS
09217	SV 8.5 STEEL	12579	09218*	08170	08344
09226	SV 9.5 STEEL	12643	09219*	08171	08344
09233	SV2 8.5 STEEL	12579	09218*	08170	08344
09236	SV2 9.5 STEEL	12643	09219*	08171	08344
09237	SV2 10.5 STEEL	13045	09111*	09304	08344

* Included with moldboard

Lift Frame		PAF/SAF Carton		Hydraulic Unit <small>ONLY ORDER 1</small>		Plow Lights <small>ONLY ORDER 1</small>	
PART NO.	DESCRIPTION	PART NO.	DESCRIPTION	PART NO.	DESCRIPTION	PART NO.	DESCRIPTION
16531	CLF PLUS	13755	SAF PLUS MOUNT	15002	V-68 12V HYD CTN	07234	NITE SABER I
				15088	V-70 12V HYD CTN	07550	NITE SABER II
				15093	V-70 24V HYD CTN	07404	EURO 24V
				08895	CENTRAL HYD KIT		

NOTES

CLASSIC PLOWS – TM SERIES (FITS LIGHT TRUCK AND SUV VEHICLES)

TM Series Product Specifications

Model #	Mounting Type	Blade Type	Moldboard Length	Moldboard Height	Moldboard Gauge	Vertical Ribs	Plow Trip Springs	Cutting Edge	Average Width at Full Angle	Angling Rams	Weight† Complete
TM-5.0	EZ Classic	Full-Trip	5' 0"	23"	14 Steel	4	2	3/8" x 6"	53"	1 1/2" x 10"	420 lb.
TM-6.0	EZ Classic	Full-Trip	6' 0"	23"	14 Steel	4	2	3/8" x 6"	64"	1 1/2" x 10"	446 lb.
TM-6.5	EZ Classic	Full-Trip	6' 6"	23"	14 Steel	4	2	3/8" x 6"	69"	1 1/2" x 10"	473 lb.
TML-6.5	EZ Classic	Full-Trip	6' 6"	23"	14 Steel	4	2	1/4" x 6"	69"	1 1/2" x 10"	425 lb.
TMP-6.5	EZ Classic	Full-Trip	6' 6"	23"	3/8" Poly	4	2	3/8" x 6"	69"	1 1/2" x 10"	485 lb.
TMP-7.0	EZ Classic	Full-Trip	7' 0"	23"	3/8" Poly	4	2	3/8" x 6"	74"	1 1/2" x 10"	491 lb.

† Weight without options.

TM Series Moldboard and Accessories

PART NO.	DESCRIPTION	CUTTING EDGES			DEFLECTORS		
		Steel	Rubber	Urethane	Molded	Rubber	Poly
09293	TM 5.0	08172*	N/A	N/A	N/A	08238	N/A
09103	TM 6.0	08173*	08237	08116	12036	08103	N/A
09102	TM 6.5	08174*	08186	08117	12037	08106	12466
09272	TML 6.5	08174*	08186	08117	12037	08106	12466
09241	TMP 6.5	08174*	08186	08117	N/A	N/A	12466
09242	TMP 7.0	08177*	08188	08118	N/A	N/A	12089

* Included with moldboard

Lift Frame		PAF/SAF Carton		Hydraulic Unit <small>ONLY ORDER 1</small>		Plow Lights <small>ONLY ORDER 1</small>	
PART NO.	DESCRIPTION	PART NO.	DESCRIPTION	PART NO.	DESCRIPTION	PART NO.	DESCRIPTION
11545	LF WRANGLER	N/A	N/A	15988	E-58H 12V HYD CTN	07234	NITE SABER I
11275	LF ALL OTHERS	N/A	N/A	15602	E-58H 24V HYD CTN	07550	NITE SABER II
						07404	EURO 24V

NOTES

CLASSIC PLOWS – STL AND ST SERIES (FITS 1/2 TON, LIGHT TRUCK AND SUV VEHICLES)

STL Series Product Specifications

Model #	Mounting Type	Blade Type	Moldboard Length	Moldboard Height	Moldboard Gauge	Vertical Ribs	Plow Trip Springs	Cutting Edge	Average Width at Full Angle	Angling Rams	Weight† Complete
STL-7.5	Classic/Plus	Full-Trip	7' 6"	25"	14 Steel	4	2	1/4" x 6"	79"	1 1/2" x 10"	614 lb.

† Weight without options.

STL Series Moldboard and Accessories

PART NO.	DESCRIPTION	CUTTING EDGES			DEFLECTORS			CURB GUARDS
		Steel	Rubber	Urethane	Molded	Rubber	Poly	
09256	STL 7.5 STEEL	08226*	08189	08119	12039	08109	12078	08344

* Included with moldboard

Lift Frame		PAF/SAF Carton		Hydraulic Unit <small>ONLY ORDER 1</small>		Plow Lights <small>ONLY ORDER 1</small>	
PART NO.	DESCRIPTION	PART NO.	DESCRIPTION	PART NO.	DESCRIPTION	PART NO.	DESCRIPTION
16531	CLF PLUS	16520	SAF PLUS MOUNT	15988	E-58H 12V HYD CTN	07234	NITE SABER I
				15602	E-58H 24V HYD CTN	07550	NITE SABER II
11255	LF CLASSIC	16507	SAF CLASSIC MOUNT	08878	CENTRAL HYD KIT	07404	EURO 24V

ST Series Product Specifications

Model #	Mounting Type	Blade Type	Moldboard Length	Moldboard Height	Moldboard Gauge	Vertical Ribs	Plow Trip Springs	Cutting Edge	Average Width at Full Angle	Angling Rams	Weight† Complete
ST 7.0	Classic/Plus	Full-Trip	7' 0"	25"	12	4	3	3/8" x 6"	74"	1-1/2" x 10"	639
ST 7.5	Classic/Plus	Full-Trip	7' 6"	25"	12	4	3	3/8" x 6"	79"	1-1/2" x 10"	686
STP 7.0	Classic/Plus	Full-Trip	7' 0"	27"	3/8" Poly	4	3	3/8" x 6"	74"	1-1/2" x 10"	691
STP 7.5	Classic/Plus	Full-Trip	7' 6"	27"	3/8" Poly	4	3	3/8" x 6"	79"	1-1/2" x 10"	738

† Weight without options.

ST Series Moldboard and Accessories

PART NO.	DESCRIPTION	CUTTING EDGES			DEFLECTORS		
		Steel	Rubber	Urethane	Molded	Rubber	Poly
09159	ST 7.0	08177*	08188	08118	12038	08108	12089
09163	ST 7.5	08226*	08189	08119	12039	08109	12078
09243	STP 7.0	08177*	08188	08118	N/A	N/A	12089
09244	STP 7.5	08178*	08189	08119	N/A	N/A	12078

* Included with moldboard

Lift Frame		PAF/SAF Carton		Hydraulic Unit <small>ONLY ORDER 1</small>		Plow Lights <small>ONLY ORDER 1</small>	
PART NO.	DESCRIPTION	PART NO.	DESCRIPTION	PART NO.	DESCRIPTION	PART NO.	DESCRIPTION
16531	CLF PLUS	16515	SAF PLUS MOUNT	15988	E-58H 12V HYD CTN	07234	NITE SABER I
				15602	E-58H 24V HYD CTN	07550	NITE SABER II
11255	LF CLASSIC	16505	SAF CLASSIC MOUNT	08878	CENTRAL HYD KIT	07404	EURO 24V

CLASSIC PLOWS – C SERIES (FITS 3/4 TON+)

C Series Product Specifications

Model #	Mounting Type	Blade Type	Moldboard Length	Moldboard Height	Moldboard Gauge	Vertical Ribs	Plow Trip Springs	Cutting Edge	Average Width at Full Angle	Angling Rams**	Weight† Complete
C-7.5	Classic/Plus	Full-Trip	7' 6"	28"	12 Steel	6	4	3/8" x 6"	79"	1 1/2" x 10"	799 lb.
C-8.0	Classic/Plus	Full-Trip	8' 0"	28"	12 Steel	6	4	1/2" x 6"	84"	1 1/2" x 10"	833 lb.
C-8.5	Classic/Plus	Full-Trip	8' 6"	28"	12 Steel	6	4	1/2" x 6"	88"	1 1/2" x 10"	846 lb.
C-9.0	Classic/Plus	Full-Trip	9' 0"	28"	12 Steel	6	4	1/2" x 6"	93"	1 1/2" x 10"	867 lb.
CP-7.5	Classic/Plus	Full-Trip	7' 6"	30"	3/8" Poly	6	4	3/8" x 6"	79"	1 1/2" x 10"	871 lb.
CP-8.0	Classic/Plus	Full-Trip	8' 0"	30"	3/8" Poly	6	4	1/2" x 6"	84"	1 1/2" x 10"	908 lb.
CP-8.5	Classic/Plus	Full-Trip	8' 6"	30"	3/8" Poly	6	4	1/2" x 6"	88"	1 1/2" x 10"	931 lb.
CP-9.0	Classic/Plus	Full-Trip	9' 0"	30"	3/8" Poly	6	4	1/2" x 6"	93"	1 1/2" x 10"	960 lb.

† Weight without options. **Design change – Note S.A.F. carton changes in selection guide for "C" Series.

C Series Moldboard and Accessories

PART NO.	DESCRIPTION	CUTTING EDGES			DEFLECTORS			CURB GUARDS	FIXED WING
		Steel	Rubber	Urethane	Molded	Rubber	Poly		
09240	C 7.5 STEEL	08178*	08189	08119	12039	08109	12078	08344	08888
09286	C 8.0 STEEL	08180*	08190	08160	12040	08111	12024	08344	08888
09983	C 8.5 STEEL	08182*	08191	08162	12041	08112	12025	08344	08888
09250	C 9.0 STEEL	08185*	08192	08164	12042	08113	12123	08344	08888
09245	CP 7.5 POLY	08178*	08189	08119	12039	08109	12078*	08344	N/A
09246	CP 8.0 POLY	08180*	08190	08160	12040	08111	12024*	08344	N/A
09247	CP 8.5 POLY	08182*	08191	08162	12041	08112	12025*	08344	N/A
09252	CP 9.0 POLY	08185*	08192	08164	12042	08113	12123*	08344	N/A

* Included with moldboard

Lift Frame		PAF/SAF Carton		Hydraulic Unit <small>ONLY ORDER 1</small>		Plow Lights <small>ONLY ORDER 1</small>	
PART NO.	DESCRIPTION	PART NO.	DESCRIPTION	PART NO.	DESCRIPTION	PART NO.	DESCRIPTION
16531	CLF PLUS	16516	SAF PLUS MOUNT	15988	E-58H 12V HYD CTN	07234	NITE SABER I
11255	LF CLASSIC	16511	SAF CLASSIC MOUNT	15602	E-58H 24V HYD CTN	07550	NITE SABER II
				08878	CENTRAL HYD KIT	07404	EURO 24V

CLASSIC PLOWS – HML AND HM SERIES (FITS 16,500-26,000 GVW)

HML Series Product Specifications

Model #	Mounting Type	Blade Type	Moldboard Length	Moldboard Height	Moldboard Gauge	Vertical Ribs	Plow Trip Springs	Cutting Edge	Average Width at Full Angle	Angling Rams	Weight† Complete
HML-10.0	Classic/Plus	Full-Trip	10.0'	32"	10 Steel	7	6	1/2" x 6"	103"	1 1/2" x 10"	1020 lb.

† Weight without options.

HML Series Moldboard and Accessories

PART NO.	DESCRIPTION	CUTTING EDGES				DEFLECTORS			CURB GUARDS
		Steel	Rubber	Urethane	10' Carbide	Molded	Rubber	Poly	
09292	HML 10.0 STEEL	08216*	08193	08167	08780	12043	08114	12124	08344

* Included with moldboard

Lift Frame		PAF/SAF Carton		Hydraulic Unit <small>ONLY ORDER 1</small>		Plow Lights <small>ONLY ORDER 1</small>	
PART NO.	DESCRIPTION	PART NO.	DESCRIPTION	PART NO.	DESCRIPTION	PART NO.	DESCRIPTION
16531	CLF PLUS	16516	SAF PLUS MOUNT	15988	E-58H 12V HYD CTN	07234	NITE SABER I
				15602	E-58H 24V HYD CTN	07550	NITE SABER II
11255	LF CLASSIC	16511	SAF CLASSIC MOUNT	08878	CENTRAL HYD KIT	07404	EURO 24V

HM Series Product Specifications

Model #	Mounting Type	Blade Type	Moldboard Length	Moldboard Height	Moldboard Gauge	Vertical Ribs	Plow Trip Springs	Cutting Edge	Average Width at Full Angle	Angling Rams	Weight* Complete
HM-9.0	HMBF - Universal	Full-Trip	9.0'	32"	7 Steel	7	6	1/2" x 6"	93"	2" x 12"	1205 lb.
HM-10.0	HMBF - Universal	Full-Trip	10.0'	32"	7 Steel	7	6	1/2" x 6"	103"	2" x 12"	1254 lb.
HMP-10.0	HMBF - Universal	Full-Trip	10.0'	36"	3/8" Poly	7	6	1/2" x 6"	103"	2" x 12"	1271 lb.

*Weight without options.

HM Series Moldboard and Accessories

PART NO.	DESCRIPTION	CUTTING EDGES				DEFLECTORS			CURB GUARDS
		Steel	Rubber	Urethane	Carbide	Molded	Rubber	Poly	
09238	HM 9.0 STEEL	08185*	08192	08164	N/A	12042	08113	12123	08344
09239	HM 10.0 STEEL	08216*	08193	08167	08780	12043	08114	12124	08344
09249	HMP 10.0 POLY	08216*	08193	08167	08780	12043	08114	12124*	08344

* Included with moldboard

Lift Frame		PAF/SAF Carton		Hydraulic Unit <small>ONLY ORDER 1</small>		Plow Lights** <small>ONLY ORDER 1</small>	
PART NO.	DESCRIPTION	PART NO.	DESCRIPTION	PART NO.	DESCRIPTION	PART NO.	DESCRIPTION
INCLUDED IN 16500		16489	SAF HMBA/INT'L/FORD	15994	E-58H 12V HYD CTN	07234	NITE SABER I
				15605	E-58H 24V HYD CTN	07550	NITE SABER II
INCLUDED IN 16486		16487	SAF HMBF	08877	CENTRAL HYD KIT	07404	EURO 24V

** Requires fender mounting light bracket #19168 if custom mount (2 required)

CLASSIC PLOWS – AG SERIES (FITS 3/4 TON+)

AG Series Product Specifications

Model #	Mounting Type	Blade Type	Moldboard Length	Moldboard Height	Moldboard Gauge	Vertical Ribs	Plow Trip Springs	Cutting Edge	Average Width at Full Angle	Angling Rams	Weight† Complete
AG-7.5	XPress	Full-Trip	7' 6"	32"	14 Steel	6	4	3/8" x 6"	78"	1 1/2" x 10"	850 lb
AG-8.0	XPress	Full-Trip	8' 0"	32"	12 Steel	6	4	1/2" x 6"	84"	1 1/2" x 10"	925 lb.
AG-8.5	XPress	Full-Trip	8' 6"	32"	12 Steel	6	4	1/2" x 6"	88"	1 1/2" x 10"	945 lb.
AG-9.0	XPress	Full-Trip	9' 0"	32"	12 Steel	6	4	1/2" x 6"	93"	1 1/2" x 10"	965 lb.

† Weight without options.

AG Series Moldboard and Accessories

PART NO.	DESCRIPTION	CUTTING EDGES			DEFLECTORS			CURB GUARDS	ADJ. WING	BOX WING	FIXED WING
		Steel	Rubber	Urethane	Molded	Rubber	Poly				
09200	AG 7.5 STEEL	08178*	08189	08119	12039	08109	12078	08344	08105	08104	08100
09205	AG 8.0 STEEL	08180*	08190	08160	12040	08111	12024	08344	08105	08104	08100
09220	AG 8.5 STEEL	08182*	08191	08162	12041	08112	12025	08344	08105	08104	08100
09215	AG 9.0 STEEL	08185*	08192	08164	12042	08113	12123	08344	08105	08104	08100

* Included with moldboard

Lift Frame		PAF/SAF Carton		Hydraulic Unit <small>ONLY ORDER 1</small>		Plow Lights <small>ONLY ORDER 1</small>	
PART NO.	DESCRIPTION	PART NO.	DESCRIPTION	PART NO.	DESCRIPTION	PART NO.	DESCRIPTION
19170	LF XPRESS	16535	PAF XPRESS MOUNT	15820	E-68 12V HYD CTN	07234 07550	NITE SABER I NITE SABER II

NOTES

PLOW ACCESSORIES

CUTTING EDGES AND CURB GUARDS

Full-trip Steel Cutting Edges (standard equipment) —

Scientifically designed to meet the demands of a tough environment. Our unique, heat-treated edges meet exacting specifications derived from years of testing to provide long-lasting performance. Pre-drilled ready for installation. Sold as complete kits or separately as required. Complete Kits come with all hardware in order to install.*

Bottom-trip Steel Cutting Edges (standard equipment) —

Scientifically designed to meet the demands of a tough environment. Our unique, heat-treated edges meet exacting specifications derived from years of testing to provide long-lasting performance. Reversible to extend life; once a side is worn, reverse the cutting edge for extended use. Pre-drilled ready for installation. Cutting edges are sold as complete kits or separately as required. Complete Kits come with all hardware in order to install.*

Full-trip Carbide Cutting Edge — Heavy-duty, carbide-tipped cutting edges significantly extend cutting edge life and deliver superior scraping performance. Reversible to extend life; once a side is worn, reverse the cutting edge for extended use. Pre-drilled ready for installation. Sold as complete kits or separately as required. Complete Kits come with all hardware in order to install.*

Bottom-trip Rubber Cutting Edge Kit — Rubber cutting edges are designed to eliminate noise while providing maximum protection to the surface. Our 1.5" thick edge is formulated for long life. Reversible to extend cutting edge life, once a side is worn, reverse the cutting edge for extended use. Pre-drilled ready for installation. Cutting edges are sold as complete kits or separately as required. Complete Kits come with all hardware in order to install.*

Bottom-trip Polyurethane Cutting Edge Kit — Provides the rigidity of steel edges and the noise reduction of rubber edges; all while protecting sensitive surfaces. Our one-inch thick edge is formulated for long life. Reversible to extend the life, once a side is worn, reverse the cutting edge for extended use. Pre-drilled ready for installation. Cutting edges are sold as complete kits or separately as required. Complete Kits come with all hardware in order to install.*

Curb Guards — Made with 3/8" steel, easy to install with pre-drilled hole pattern, curved and contoured for a perfect fit.

Comes as a set (2) and are interchangeable/reversible side to side. Ships with mounting hardware and installation instructions for an easy install.

Part #08344 LP/SV/DAG/RP
Part #08343 C/AG/HM

Full-trip Rubber Cutting Edge Kit— Designed to eliminate noise while providing maximum protection to sensitive surfaces. Our 1.5" thick edge is formulated for long life. Reversible to extend cutting edge life, once a side is worn, reverse it for extended use. Pre-drilled ready for installation. Cutting edges are sold as complete kits or separately as required. Complete Kits come with all hardware in order to install.*



Full-trip Polyurethane Cutting Edge Kit — Provides the rigidity of steel edges and the noise reduction of rubber edges, while protecting sensitive surfaces. Our one-inch thick edge is formulated for long life. Pre-drilled ready for installation. Cutting edges are sold as complete kits or separately as required. Complete Kits come with all hardware in order to install.



DEFLECTORS

Meyer Heavy-duty Molded Deflectors —

Made of rigid polyethylene, deflectors reduce blow-back on the windshield, and accentuate the snow rolling action. The 45 degree angle end-cut helps throw snow more precisely for a quicker, cleaner scrape. Pre-drilled and ready for installation. Deflectors come ready to install with hardware bag and steel mounting belt. Components also sold separately as required.



Meyer Rubber Snow Deflectors —

Made of pliable heavy duty rubber, the deflector keeps snow flume down and away from the windshield and accentuates the snow rolling action. Pre-drilled and ready for installation. Complete Deflector Kits come ready to install with hardware bag and steel mounting belt. Components also sold separately as required.



Meyer Poly Snow Deflectors —

Made of pliable poly, the deflector keeps snow flume down and away from the windshield and accentuates the snow rolling action. Pre-drilled and ready for installation. Complete Deflector Kits come ready to install with hardware bag and steel mounting belt. Components also sold separately as required.



HAND-HELD CONTROLLERS

Joystick Controller with ALM/ARM — Operates with straight blades and V-plows. Controller is illuminated and automatically senses the blade type (V or Straight blade); also equipped with self-diagnostics. ALM/ARM — To reduce effort and increase performance and safety, Meyer has made basic operation of the plow automatic! The ARM mode automatically raises the plow when the operator shifts the vehicle to reverse. The ALM mode automatically lowers the plow when the operator shifts the vehicle to reverse. Unit operates both 12V and 24V systems and comes with instructions and adapter for an easy do-it-yourself install.

Part #22790X Joystick
Part #22265C Leg Strap



* Note: See plow specification page or website for exact part numbers.

PLOW ACCESSORIES

Pistol Grip Controller with ALM/ARM — Features automatic raise mode (ARM) and automatic lower mode (ALM). To reduce effort and increase performance and safety, Meyer has made basic operation of the plow automatic! The ARM mode automatically raises the plow when the operator shifts the vehicle to reverse. The ALM mode automatically lowers the plow when the operator shifts the vehicle to reverse. It features one-button functionality, illuminated buttons and self-diagnostics. This pistol grip controller retrofits back to replace Meyer Touch Pad Controller (part #22154). Unit operates both 12V and 24V systems and comes with instructions and adapter for an easy do-it-yourself install.

Part #22690X Pistol Grip
Part #22265C Leg Strap



Pistol Grip DLX Controller with ALM/ARM — Operates MEYER straight and Super-V plows. It features automatic raise mode (ARM) and automatic lower mode (ALM). To reduce effort and increase performance and safety, Meyer has made basic operation of the plow automatic! The ARM mode automatically raises the plow when the operator shifts the vehicle to reverse. The ALM mode automatically lowers the plow when the operator shifts the vehicle to reverse. It features one-button functionality, illuminated buttons and self-diagnostics. This pistol grip controller retrofits back to replace Meyer Touch Pad Controller (part #22154). Unit operates both 12V and 24V systems and comes with instructions and adapter for an easy do-it-yourself install.

Part #22695X Pistol Grip
Part #22265C Leg Strap



Touch Pad Controller — Intuitive design with large illuminated raised rubber indicator arrows for ease of use. Unit features self-diagnostics. Convenient indicator lights make it simple to see the status of the plow. Unit comes with instructions and hardware for an easy do-it-yourself install.

Part #22154 Touch Pad
Part #22265C Leg Strap



If replacing original touch pad #22125 you need to order a #08644 adapter plug in addition to the #22154.

WINGS

Multi-Position Wings—Meyer EZ-Wing™ — Greatly improve the performance and efficiency of your Lot Pro moldboard. Each wing can be positioned independently to create a box, scoop or straight blade configuration (up to nine positions) with the pull of a pin. Adds nearly 2.5 feet of overall length to Lot Pro moldboards. Fits all Lot Pro and AG moldboards 7.5' through 10.0'. Installs with no moldboard modification and assembles with pins for quick removal or bolts for long-term use. Comes as a set (2) left and right. Hardware and mounting instructions included.

Part #08105 Multi-Wing For Lot Pro/AG Steel
Part #08115 Multi-Wing For Lot Pro Poly



Fixed-Position 45 Degree Wings — Extends the moldboard 10" on each side. Fits all Lot Pro and AG moldboards 7.5' through 10.0'. Installs with no moldboard modification and assembles with pins for quick removal or bolts for long-term use. Comes as a set (2) left and right. Hardware and mounting instructions included.

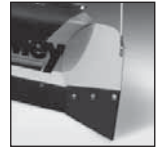

Part #08100 Fixed-Wing For Lot Pro/AG Steel
Part #08110 Fixed-Wing For Lot Pro Poly

Fixed-Position 45 Degree Wings — Extends the moldboard 10" on each side. Fits all C-Series and ST Steel moldboards 7.5' through 9.0'. Comes as a set (2) left and right. Hardware and mounting instructions included.

Part #08888 (C, ST)

Box Wings — Converts all steel and poly Lot Pro and AG moldboards into a push plow. Features reinforced design with heavy-duty rubber cutting edge. Installs with no moldboard modification and assembles with pins for quick removal or bolts for long-term use. Fits all Lot Pro and AG moldboards 7.5' through 10.0'. Comes as a set (2) left and right. Hardware and mounting instructions included.

Part #08104 (LP, LPP, AG)



LIGHTS

Nite Saber® II Lights — Use state-of-the-art design to maximize visibility and safety. Features include: Four head lamp system — superior forward and a wider curbside beam pattern for safer, easier and more productive plowing; Complex reflector headlight system — allows more light energy from the headlight bulb to be used to light the road; Large access rear door — makes bulb replacement easy; High output harness system — ensures that maximum electrical energy is transmitted to the headlight system; Single bolt adjustable mounting — allows faster installation and adjusting when necessary. Lights ship as a left and right set, including all hardware and instructions for a quick installation:



Lights Only

Part #07549 (plug and play replacements)

Lights and Modules

Part #07550 (new installation)

Fender Mounting Brackets – Lights (HM and Road Pro)

Part #19168 (2 required)

Replacement Bulbs:

(available at popular hardware and auto parts stores)

Nite Saber I

Low and High Beam = 3157 NA

Nite Saber II

Low Beam = H7 (55W) Halogen

High Beam = H1 (55W) Halogen

Amber Turn Signal = 1157 NA

PLOW ACCESSORIES

ACCESSORIES

Central Hydraulic Kit — Allows you to plumb the plow directly to the vehicle's hydraulic system. Kit comes complete with two (2) municipal duty angling rams, a lift ram cylinder (1) and complete hardware kit and installation instructions. (Hoses provided by installer.)

Part #08878 C Series and Lot Pro
Part #08877 HM Series
Part #15853 Road Pro
Part #08895 Super V Series

Road Pro Out-front Hydraulic E-70 — The 12V system is the perfect solution for customers that want to add a plow to vehicles that do not have central hydraulics. Includes all components to install the unit on the lift frame and features a large "see through" hydraulic reservoir for easy filling. Includes Pistol Grip controller, electrical harnessing, two (2) municipal duty angling rams, a lift ram cylinder (1), complete hardware kit and installation instructions.



Part #15825

Meyer Hydraulic Cover — The cover, made of sub-zero composite material, fits snugly over the hydraulic unit for maximum protection. All unit maintenance and feature functions can be accessed conveniently while the cover is on. Fits Meyer E-57 and E-58 Series Hydraulic units. Cover comes with hardware for a quick and easy installation.



Part #15630 Cover
Part #15631 Strap

Manual Angle Kit — This kit allows you to manually adjust a plow angle to the right or left by releasing a pin, manually moving the moldboard in the desired direction, then re-inserting the pin in the appropriate hole. This kit contains the inner and outer ram cylinders and attaching hardware.

Part #08872 Skid Steer; Utility Tractor; Airport Tractors; Compact Tractor

Power Lift Kit — Ties into the vehicle's central hydraulic system to enable remote lifting of the snowplow. Consists of a lift ram, needle valve and hose assembly.

Part #08299 Utility Tractor

Full Remote Operation Kit E-58H — The 12V system provides the operator total remote control of the snowplow — up, down, right or left — using an independent hydraulic system. It consists of all the hardware and components the installer needs to have full remote capabilities including the hydraulic unit, electrical harness and controller.

Part #15988 Utility Tractor



Meyer Hydraulic Unit Lock — Prevent your valuable Hydraulic unit from theft with our Stainless Steel Hydraulic Lock. 3" locking pin replaces existing bolt, works on all Meyer hydraulics. Quick disconnect/connect design makes changes fast and easy. Lock comes with a set of keys (2) complete with instructions for quick and easy installation.



Part #07695C

Snow Shoes — Allows the user to set the scraping height of the cutting edge. The Lot Pro shoe is a heavy-duty steel cast for maximum longevity and durability. The mushroom design will rotate 360 degrees eliminating hang-ups or catching of unwanted objects. In addition, the mushroom design is convenient for back-dragging applications. Fits all Lot Pro moldboards. Lot Pro Shoes come per each (1) and include all mounting hardware for easy installation.



Part #09362 (per ea.) Lot Pro
Part #09214 (set of 2) Super V

Snow Shoes Drive Pro — Allows the user to set the scraping height of the cutting edge. The Drive Pro shoe is heavy duty steel-formed for maximum longevity and durability. The mushroom design will rotate 360 degrees eliminating hang-ups or catching of unwanted objects. Design is convenient for back-dragging applications. Fits all Drive Pro moldboards. Shoes come per each (1) and include all mounting hardware for easy installation.

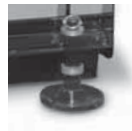

Part #09127 — Fits: TM/STL/DP

Snow Shoes Road Pro — Allows the user to set the scraping height of the cutting edge. The Road Pro shoe is heavy-duty cast iron formed for maximum longevity and durability. The mushroom design is convenient for back-dragging applications. The cutting height is adjustable with a single crank on each shoe. The mushroom base has a replaceable wear disc and is replaceable (19056). Fits all Road Pro, DAGX and AG-X moldboards. Shoes come as a set (2) and include all mounting hardware for easy installation.



Part #09295 Kit
Part #19056 Replaceable Wear Disc

Snow Shoes Meyer Diamond Edge — Allows the user to set the scraping height of the cutting edge. The shoe is a heavy-duty steel cast for maximum longevity and durability. Specially designed shape corks in tandem with the trip edge to ensure maximum performance. Fits all Meyer Diamond Edge moldboards. Shoes come per each (1). Part #84040 Shoe Only
Part #20361(1) and 811000224(10) Hardware

Snow Shoes — Allows the user to set the scraping height of the cutting edge. The shoe is a heavy-duty steel cast for maximum longevity and durability. Shoes come as one ea. (1) and include all mounting hardware for easy installation.

Part #09126 Fits: ST (P) and C
Part #09592 Fits: HM

PLOW ACCESSORIES

Plow Markers — Allow the operator to see the edge of his plow from the cab providing maximum visibility for increased performance and safety. Made from solid tubing, markers are flexible yet durable to withstand the winter environment. Markers are pre-drilled to fit the moldboard, no drilling is necessary. Markers are shipped two (2) per set and include all mounting hardware and instructions for easy do-it-yourself installation.

Part #09917 Fits: DP, LP, AG, DAG, RP series
Part #09916 Fits: TM, ST, STL, C, HM series



Meyer Receiver Hitch Cover — This all-steel, powder coated hitch cover is a perfect companion to your receiver hitch. Hitch covers keep unwanted debris and elements from corroding the hitch, extending life. The Meyer cover fits a standard 2"x2" receiver hitch and is easily removable using a convenient locking pin. Units ship per each.

Part # 03569

Meyer Winch Cradle — Conveniently fits to the plow mounting system when the plow is removed. The Winch Cradle fits most Ramsey and Warn winches (under 10,000lbs.) with a 10"x 4.5" bolt pattern. Unit comes complete with all mounting hardware and instructions. Easy to assemble and install. (Winch Cradle does not include the winch)

Part #16529 Plus / MDII
Part #16527 TM Classic
Part #16533 TM Jeep
Part #16528 Classic
Part #16542 2"x2" Rear Receiver Hitch



Light Guards – EZ-Mount Express —

Conveniently bolt on to your EZ-Mount Xpress lift frame. Comes complete as a set (1 left and 1 right) includes mounting hardware and easy do-it-yourself installation instructions.

Part #16536 Fits '99-'07 Ford
Part #16537 Fits '99+ Chevy
Part #16539 Fits '99+ Dodge



Brush Guards – EZ-Mount Classic — Converts your EZ-Mount Classic into a fully functional Brush Guard system. Comes complete as one (1) unit.

Part #11558 EZ-Mount Classic-Full Frame
Part #11559 EZ-Mount Classic with smaller/ TM- 11275 lift frame
Part #11937 EZ-Mount Classic - Jeep/TM-11545 lift frame)

Brush Guard and Light Guards – EZ-Mount Plus — Converts your EZ-Mount Plus into a fully functional Brush Guard when your plow is off the truck. Comes complete as one (1) unit. Light Guards sold separately come as a set (left and right).

Brush Guard:

Part #08300 (EZ-Mount Plus)

Light Guards – Fit onto the 08300

Part #16536 ('99-'07 Ford)
Part #16537 ('99+ Chevy)
Part #16539 ('99+ Dodge)

OILS – PAINTS - GREASE

Meyer Sno-Flo™ Industrial Paint — Our specially formulated paint is designed to improve snow-rolling action and withstand the harsh operational environment. Meyer Yellow, Black and White Primer is available in aerosol spray cans (12/case) and Meyer Yellow is available in 1 quart cans (12/case) that can be shipped via UPS.

Part #08755 Brush Yellow (12/1qt.cans/UPS)
Part #08677 Spray Case Yellow (12cans/case)
Part #08676 Spray Case Black (12cans/case)
Part #08841 Spray Case White Primer (12cans/case)



Meyer M1 Hydraulic Fluid — Keep your hydraulic unit operation at factory performance by using OEM M1 Hydraulic Fluid. Meyer M1 Hydraulic fluid is scientifically formulated to withstand the extreme temperatures. Meyer's exclusive additives maximize performance and longevity of the complete operating system. M1 Hydraulic Fluid is guaranteed to perform at temperatures of -40°F. It is recommended that you drain the M1 Hydraulic in the spring, fill and store the unit with Hydra-Flush over the summer then refill with new M1 Hydraulic fluid in the fall. Note: using other hydraulic fluids or additives voids your warranty and may permanently damage your unit. Comes in case/box of 12 and includes easy pour spout or by the bottle.

Part #15487 (case/12)
Part #15614 (55 gal. Drum)



Meyer M2 Hydraulic Flush — Keeping your hydraulic unit internally clean is as important as keeping your engine clean. Meyer's M2 Hydraulic Flush is designed to scrub the internal components and flush away all impurities that may have developed in the system. Our exclusively designed M2 Flush is designed to perform without harming seals, connectors or hydraulic ports. It is recommended that you drain the M1 Hydraulic in the spring, fill and store the unit with Hydra-Flush over the summer then refill with new M1 Hydraulic fluid in the fall. Comes in case/box of 12 and includes easy pour spout or by the bottle.

Part #15902 (case/12)
Part #15903 (5 Gal. Pail)
Part #15904 (55 Gal. Drum)



Meyer Dielectric Grease — Protect your valuable system from the harsh winter elements with Meyer's dielectric grease. Specially formulated to coat and protect electrical connections from deteriorating elements such as salt and road grime. It is recommended to coat all electrical connections prior to winter and each time you reconnect to ensure optimal performance. Grease comes per each, 2.7 oz tube. Part #15632



BROADCAST SPREADERS – HOTSHOTS



Hotshot 70

Hotshot 70 HD

Hotshot™/Hotshot HD™ - Broadcast Spreaders

- Compact, tough and built to handle extreme temperatures, moisture and corrosive materials typically found in year-round grounds maintenance use
- Specifically designed for Topdress Sand, Icemelt, Limestone and Fertilizer applications
- Features large, heavy duty Nylatron GS (Teflon® impregnated and greaseless) gears for superior durability and a quick release gear cover for easy servicing (*HD only*)
- Axle and wheel bearings/bushings provide self-lubrication with excellent wear and load carrying performance
- 1.3 cubic foot polypropylene hopper has a 70 lb. capacity which converts to up to 1-1/2 bags of fertilizer/Icemelt
- Standard fitted, see-through cover keeps the weather out and the material in
- All Hotshots feature a fully enclosed rebuildable gearbox

SPREADERS/
ACCESSORIES



Standard Hopper Cover

Keeps the elements out and the material in during harsh or windy conditions.



Quick Removal Deflector Shield

All Hotshots are equipped with an easy-to-remove deflector shield that prevents the material from flying too far.



Pneumatic Tires

The standard Hotshot has 10-inch tires, while the 100-pound versions have 13-inch tires to make it easier to move across uneven terrain or surfaces.



Sealed Gear Boxes

The axle and wheel bearings/bushings are enclosed in sealed gear boxes which are self-lubricating for excellent wear and load-carrying performance.



Standard Mesh Screen

Helps break up large chunks of material to help eliminate clogging.

TAILGATE SPREADERS – 240, MINI JR.™ AND MATE™



240

- 1/8HP direct drive motor
- 240 lb. capacity (3 cu. ft.)
- For SUVs, light trucks and utility vehicles
- Standard Hi/Lo/Off controller
- Spread width up to 25 feet
- Spreads salt only
- 2" square receiver hitch mount
- Built-in motor guard



Mate™ - Tailgate Spreader

- 9 cubic foot capacity and attaches (without tools) in seconds
- Comes fully assembled for quick and easy installation to your truck's tailgate and bumper, so there's nothing to drill
- Spinner shaft can be adjusted to accommodate dry, free flowing #1 rock salt, sand or calcium chloride
- Can spread seed and other materials for year-round applications
- Powered by a 1/8-horsepower, 12-volt DC electric motor and has variable in-cab speed control
- Standard vibrator motor is provided for use with sand and damp materials to maximize performance
- Spread widths from 3 to 30 feet
- 1 year warranty



Mini Jr.™

- Easy to use and ideal for many small to medium sized jobs from walkways to small parking lots
- Works with B series tractors and is ideal for spreading dry, free flowing #1 rock salt
- 400 lb. capacity polymer hopper gives you the productivity to handle several jobs with one load
- Mounts using a standard 2" square receiver and provides in cab speed control
- Spread patterns from 3 to 30 feet
- Optional salt screen is removable
- 1 year warranty

Shown with optional motor guard
Part #34607

SPREADERS/
ACCESSORIES



Mate Motor Guard

This optional accessory protects the spinner assembly and fits 2" standard square receiver. Part #38250



Mate EZ-Swing™

This optional tailgate swing accessory allows the entire unit to swing out of the way for tailgate access. Part #38010



Direct Drive 1/8HP Motor

Applies the torque directly to the auger to grind through large chunks of salt or sand.

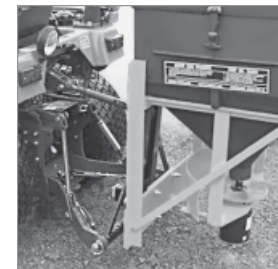

3-Point Hitch System

Are available for Ag and Turf applications. Part #36500 Jr. Part #38200 Mate Part #36500 240



Mini Jr. Motor Guard

Protects the spinner assembly. Part #36407



Mate Salt Screen

Screens material prior to filling to break-up clumps. Part #38260



Mini Jr. Salt Screen

Includes built-in bag cutter to open bags of salt. Part #36600

TAILGATE SPREADERS – 240, MINI JR.™ AND MATE™

240 Specifications

Model	Part #	Capacity	Height	Weight	Width	Depth	Hopper	Operating System	Mounting Method	Vehicle Application
Meyer 240	31000	240 lbs	30"	96 lbs	23"	27"	Poly	12V Electric	2" receiver hitch mount (std)	Class 1, SUV's, Utility Vehicles

Mini Jr.™ Specifications

Model	Part #	Capacity	Weight	Height	Width	Depth	Hopper	Operating System	Mounting Method	Vehicle Application
Mini Jr	36006	5.75 cu. ft.	132 lbs	40"	28"	28"	Poly	12V Electric	2" receiver hitch mount (std)	SUV - 1 ton (1-2-3 GVW Class)

Mate™ Specifications

Model	Part #	Capacity	Weight	Height	Width	Depth	Hopper	Operating System	Mounting Method	Vehicle Application
Mate XL	38000	9.0 cu. ft.	216 lbs	31"	48"	33"	Poly	12V Electric	Tailgate Strap	1/2 ton - 1 ton (2-3 GVW Class)

240, Mini Jr.™ and Mate™ Accessories

	Meyer 240	Mini Jr.™	Mate™
3 Point Hitch Mounting	36500	36500	38200
Salt Screen	N/A	36600	38260
Tailgate Swing Kit	N/A	N/A	38010
Motor Guard	N/A	36407	38250
Spreader Controller	34417	22800	22800
The Big Yellow Box	32403	32403	32403
LED Rear Light Package	34610	34610	N/A
Halogen Rear Light Package	34609	34609	N/A
Meyer Dielectric Grease	15632	15632	15632
Meyer Sno-Flow Industrial Paint – Brush Yellow (4/1 qt. cans/UPS)	08755	08755	08755
Meyer Sno-Flow Industrial Paint – Spray Case Yellow (12 cans/case)	08677	08677	08677
Meyer Sno-Flow Industrial Paint – Spray Case Black (12 cans/case)	08676	08676	08676
Meyer Sno-Flow Industrial Paint – Spray Case White Primer (12 cans/case)	08841	08841	08841

NOTES

TAILGATE SPREADERS – BLASTER



Part #32000



Part #33750*

Blaster - Tailgate Spreaders

- Seven mounting systems available to fit SUV's, light trucks, and ½ ton+ vehicles
- 350 or 750 lb capacities available
- Variable speed controller for precise material spread pattern
- Motor and controller deliver a continuous 40 amps during normal operation and surges to 70 amps when the blast feature is pressed to grind through rock salt, calcium chloride and other ice melting materials
- Low maintenance polyethylene hopper and 304 stainless steel spinner provide years of service
- ROC 3/5 year warranty
- Spread widths from 3 to 20 feet
- Electric operating system

Part #32000 – 350

Part #33000 – 750

Part #37000 – 350S

Part #39000 – 750S

Part #33750 – 750R

**Shown with optional work light kit, motor guard and storage stand.*



Spreader Rear Work Lights

Meyer offers two options for rear lighting. Each includes a work light and a brake light. Either light package mounts to any rear location and brightens up the rear of the truck. The lights are fully adjustable and plug into a standard trailer hitch power cord.
Part #34610 Heavy-Duty LED Rear Light Pkg
Part #34609 Halogen Rear Light Pkg



Removable Hopper Screen

The removable, welded-steel mesh hopper screen prevents large chunks of material into the hopper and improves material flow. Available in 2" x 2" or ½" x ½" mesh.
Part #34700 2" mesh
Part #34701 ½" mesh



Explosion Proof Motor

The Blaster's unique ½ horsepower motor is rated at up to 70 amps of surge power to grind through chunks of salt or sand. The direct-drive system applies the torque directly to the auger.

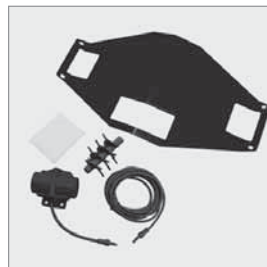

Vibrator Kit

Standard on 350S and 750S models, lets you spread a 50/50 blend of rock salt and sand or sand only. Includes extended auger, vibrator, vibrator mounting plate, baffle plate and vibrator harness.
Part #34600



Optional Motor Guard

Provides extra motor protection during use and storage.
Part #36407

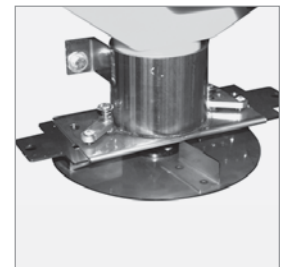

Flow Gate Control

Provides manual adjustment of material flow to the spinner.
Part #34800

TAILGATE SPREADERS – BLASTER

Blaster Specifications

Model	Part #	Hopper Length	Capacity	Weight	Height	Width	Length	Hopper	Material	Mounting Method	Vehicle Application
Blaster 350	32000	N/A	350 lbs. 5.75 cu.ft.	175 lbs	35.5"	24"	49"	Poly	Bagged Rock Salt	2" receiver (std); Cat. 1, 3 point hitch (opt); Flatbed Utility Adapter (opt)	SUV, Light truck, 1/2 ton+
Blaster 350S w/Vibrator	37000	N/A	350 lbs. 5.75 cu.ft.	185 lbs	35.5"	24"	49"	Poly	Bagged 50/50 Rock Salt/Sand or Sand	2" receiver (std); Cat. 1, 3 point hitch (opt); Flatbed utility adapter (opt)	SUV, Light truck, 1/2 ton+
Blaster 750	33000	N/A	750 lbs. 10.75 cu.ft.	198 lbs w/o mount	44.5"	24"	49"	Poly	Bagged Rock Salt	Hinged, Dump, Fixed, Flat Bed (all optional)	1/2 ton+
Blaster 750S w/Vibrator	39000	N/A	750 lbs. 10.75 cu.ft.	208 lbs w/o mount	44.5"	24"	49"	Poly	Bagged 50/50 Rock Salt/Sand or Sand	Hinged, Dump, Fixed, Flat Bed (all optional)	1/2 ton+
Blaster 750R	33750	N/A	750 lbs. 10.75 cu.ft.	229 lbs w/o mount	44.5"	24"	49"	Poly	Bagged 50/50 Rock Salt	Integrated 2" receiver	1/2 ton+

Blaster Accessories

	Blaster 350	Blaster 350S	Blaster 750	Blaster 750S	Blaster 750R
3 Point Hitch Mounting	36500	36500	N/A	N/A	N/A
Flatbed Vehicle Mount	35002	35002	N/A	N/A	N/A
Fixed Tailgate Mount	N/A	N/A	35200	35200	N/A
Dump Body Mount	N/A	N/A	35300	35300	N/A
Flat Bed Tailgate Mount	N/A	N/A	35400	35400	N/A
Hinged Tailgate Mount	N/A	N/A	35500	35500	N/A
Sand/Salt Vibrator Kit	34600	Included	34600	Included	34600
Hopper Screen 2" x 2"	34700	34700	34700	34700	34700
Hopper Screen 1/2" x 1/2"	34701	34701	34701	34701	34701
Flow Gate Assembly	34800	34800	34800	34800	34800
Industrial Light Kit RD	34609	34609	34609	34609	34609
Industrial Light Kit HD	34610	34610	34610	34610	34610
Universal Motor Guard	34407	34407	34407	34407	34407

NOTES

INSERT HOPPER SPREADERS – LPV AND PV

LPV

- Designed for 1/2 to 1-ton pickups
- Overall height is 25% less than typical pickup truck spreaders, rearward visibility is significantly increased
- Powered by a sealed, 12V electric motor and has fewer parts, which means less maintenance and less downtime
- Available in 0.56 to 0.95 cubic yard capacities and lengths of 3, 4, 6, 7 and 8 feet
- Spread widths from 3 to 20 feet
- Gas engine is available
- Spreads sand, salt or mixed material
- 1 year warranty

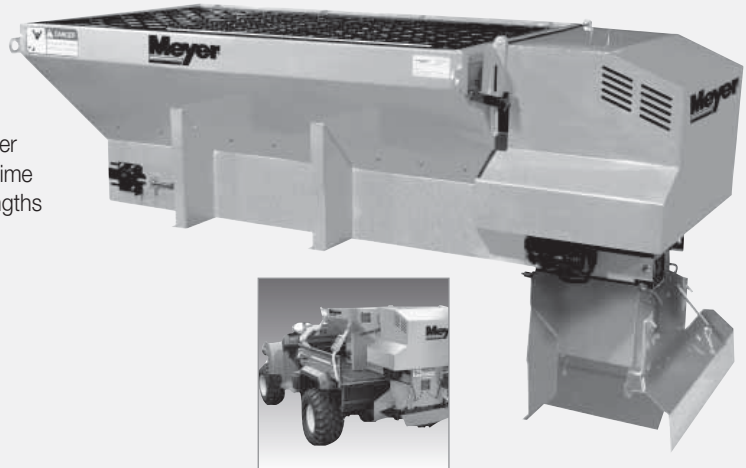

4' Utility Vehicle

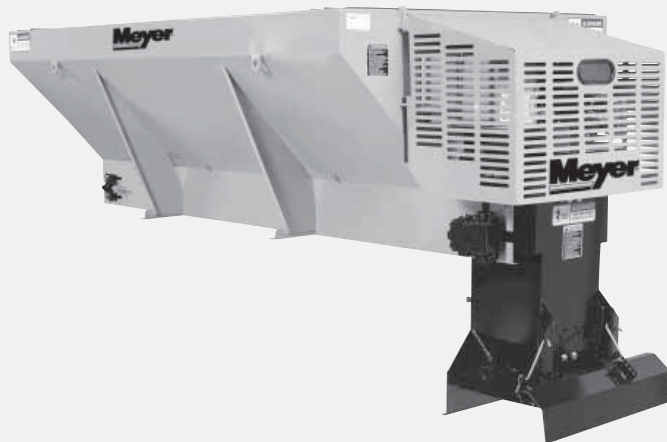

PV

- Fits most 3/4 to 1-ton heavy duty pickup trucks
- Available in 7 and 8 foot lengths and has 1.8 and 2.0 cubic yard capacities
- Spread widths from 3 to 30 feet
- Gas engine is available
- Spreads sand, salt or mixed material
- 1 year warranty



Gas

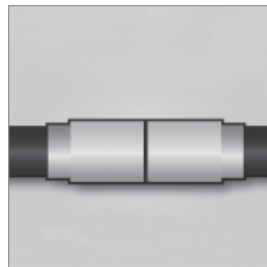

Central Hydraulics



Adjustable Baffles (Spinner Internal and External)

With Meyer's two internal and four external baffle adjustment systems, you will place the material in the right place, every time. Whether you want to spread four feet to the left, four feet to the right or spread a thirty foot pattern, you can easily adjust the spreading pattern to meet your unique demands.



Optional 30-Gallon Pre-Wet System

Decreases salt consumption. Includes cab-mounted variable speed controller and two variable orifice rubber nozzles to evenly treat material. Part #63938



Electric



Gas Over Hydraulic

Four Drive Options

Depending on your needs, Meyer insert hopper spreaders can be fitted with electric, gas, hydraulic or gas over hydraulic driven.

INSERT HOPPER SPREADERS – LPV AND PV

LPV Specifications

Model	Part #	Hopper Length	Capacity	Weight	Height	Width	Length	Hopper	Operating System	Mounting Method Hold Down Kit	Vehicle Application	Conveyor System
LPV- Electric SS	63136	5 ft	0.56 cu yd	472 lbs	25"	36"	80"	Stainless Steel	Electric 12V Sealed Motor	Part #62562	1/2 + (2-3 GVW Class)	Drag Chain
LPV-Electric SS	63137	6 ft	0.69 cu yd	510 lbs	25"	36"	92"	Stainless Steel	Electric 12V Sealed Motor	Part #62562	1/2 + (2-3 GVW Class)	Drag Chain
LPV-Electric SS	63138	7 ft	0.82 cu yd	548 lbs	25"	36"	104"	Stainless Steel	Electric 12V Sealed Motor	Part #62562	1/2 + (2-3 GVW Class)	Drag Chain
LPV-Electric SS	63139	8 ft	0.95 cu yd	586 lbs	25"	36"	116"	Stainless Steel	Electric 12V Sealed Motor	Part #62562	1/2 + (2-3 GVW Class)	Drag Chain
LPV- Electric Utility	63394	3 ft	0.3 cu yd	396 lbs	25"	36"	56"	Stainless Steel	Electric 12V Sealed Motor	Part #62562	Utility Vehicle	Belt over Chain
LPV- Electric Utility	63395	4 ft	0.43 cu yd	434 lbs	25"	36"	68"	Stainless Steel	Electric 12V Sealed Motor	Part #62562	Utility Vehicle	Belt over Chain
LPV-6.5 B&S-SS	63396	3ft	0.3 cu yd	396 lbs	25"	36"	56"	Stainless Steel	6.5hp B&S Gas	Part #62562	Utility Vehicle	Belt over Chain
LPV-6.5 B&S-SS	63397	4 ft	0.43 cu yd	434 lbs	25"	36"	68"	Stainless Steel	6.5hp B&S Gas	Part #62562	Utility Vehicle	Belt over Chain

LPV Accessories

	LPV 3 FT SS	LPV 4 FT SS	LPV 3 FT SS 6.5HP B&S	LPV 4 FT SS 6.5HP B&S	LPV 5 FT SS	LPV 6 FT SS	LPV 7 FT SS	LPV 8 FT SS
6" Side Extension	N/A	N/A	N/A	N/A	N/A	N/A	N/A	63538
LPV, PV Hold Down Kit	62562	62562	62562	62562	62562	62562	62562	62562
Battery Harness Kit	62565	62565	62565	62565	62565	62565	62565	62565

PV Specifications

Model	Part #	Hopper Length	Capacity	Weight	Height	Width	Length	Hopper	Operating System	Mounting Method Hold Down Kit	Vehicle Application	Conveyor System
PV-B&S 10.5 hp	63788	7 ft	1.8 cu yd	980 lbs	34"	50"	102"	Mild Steel	10.5hp B&S Gas	Part #62562	3/4 ton + (2-3 GVW Class)	Drag Chain
PV-B&S 10.5 hp	63790	7 ft	1.8 cu yd	980 lbs	34"	50"	102"	Stainless Steel	10.5hp B&S Gas	Part #62562	3/4 ton + (2-3 GVW Class)	Drag Chain
PV-Honda 11.0 hp	63789	7 ft	1.8 cu yd	980 lbs	34"	50"	102"	Mild Steel	11.0hp Honda Gas	Part #62562	3/4 ton + (2-3 GVW Class)	Drag Chain
PV-Honda 11.0 hp	63791	7 ft	1.8 cu yd	980 lbs	34"	50"	102"	Stainless Steel	11.0hp Honda Gas	Part #62562	3/4 ton (2-3 GVW Class)	Drag Chain
PV-B&S 10.5 hp	63792	8 ft	2.0 cu yd	1040 lbs	34"	50"	114"	Mild Steel	10.5hp B&S Gas	Part #62562	1 ton (2-3 GVW Class)	Drag Chain
PV-B&S 10.5 hp	63794	8 ft	2.0 cu yd	1040 lbs	34"	50"	114"	Stainless Steel	10.5hp B&S Gas	Part #62562	1 ton (2-3 GVW Class)	Drag Chain
PV-Honda 11.0 hp	63793	8 ft	2.0 cu yd	1040 lbs	34"	50"	114"	Mild Steel	11.0hp Honda Gas	Part #62562	1 ton (2-3 GVW Class)	Drag Chain
PV-Honda 11.0 hp	63795	8 ft	2.0 cu yd	1040 lbs	34"	50"	114"	Stainless Steel	11.0hp Honda Gas	Part #62562	1 ton (2-3 GVW Class)	Drag Chain
PV-Hydraulic Drive	63805	7 ft	1.8 cu yd	980 lbs	34"	50"	102"	Mild Steel	Central Hydraulics	Part #62562	3/4 ton + (2-3 GVW Class)	Drag Chain
PV-Hydraulic Drive	63806	7 ft	1.8 cu yd	980 lbs	34"	50"	102"	Stainless Steel	Central Hydraulics	Part #62562	3/4 ton + (2-3 GVW Class)	Drag Chain
PV-Hydraulic Drive	63807	8 ft	2.0 cu yd	1040 lbs	34"	50"	114"	Mild Steel	Central Hydraulics	Part #62562	1 ton (2-3 GVW Class)	Drag Chain
PV-Hydraulic Drive	63808	8 ft	2.0 cu yd	1040 lbs	34"	50"	114"	Stainless Steel	Central Hydraulics	Part #62562	1 ton (2-3 GVW Class)	Drag Chain

PV Accessories

	PV 7 FT Carbon 10.5HP B&S	PV 7 FT Carbon 11HP Honda	PV 8 FT Carbon 10.5HP B&S	PV 7 FT Carbon Hydr.	PV 7 FT SS 10.5HP B&S	PV 7 FT SS 11HP Honda	PV 8 FT SS 10.5HP B&S	PV 8 FT SS 11HP Honda	PV 7 FT SS Hydr.
LPV, PV Hold Down Kit	62562	62562	62562	62562	62562	62562	62562	62562	
LPV, PV Vehicle Wiring Harness	62565	62565	62565	62565	62565	62565	62565	62565	
Wireless Controller Package (Gas)	63688	63688	63688	N/A	63688	63688	63688	63688	
PV 6" Side Extensions SS	63924	63924	63895	63924	63925	63925	63926	63925	
Vibrator Kit	63390	63390	63390	63390	63390	63390	63390	63390	
PV Tarp Kit (1.8 and 2.0 cu yd)	62546	62546	62546	62546	62546	62546	62546	62546	
30 Gal. PV Pre-Wet System (2-15 gal.)	63938	63938	63938	63938	63938	63938	63938	63938	

INSERT HOPPER SPREADERS – MDV AND POLYHAWK

MDV

- Designed to bring volume and versatility to your vehicle fleet with increased material capacity for heavy duty trucks (15,000+ GVW)
- Available in 9 and 10 foot lengths with 4 to 4.5 cubic yard capacities
- A 10hp Briggs & Stratton engine is standard; 11hp Honda engine is available
- Spread widths from 4 to 30 feet
- Spreads sand, salt or mixed material
- 1 year warranty
- For 1 ton + (5-6 GVW Class) vehicles

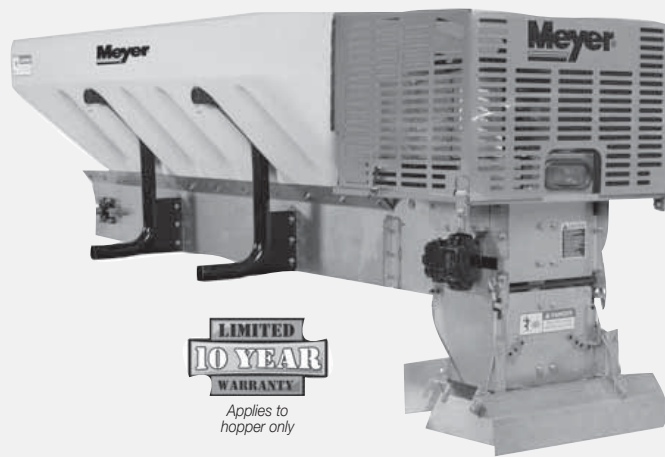

POLYHAWK

- Internal/external baffle system lets you place material exactly where you want it
- Top screens break up large chunks of material
- Standard built-in chain shields eliminate material build-up
- Includes standard wireless controller
- Swing-up spinner for cleaning and easy cleanout
- Fork pockets make spreader removal quick and easy
- Spread widths from 4 to 30 feet
- Spreads sand, salt or mixed material
- 1 year warranty
- For 3/4 ton+ (2-3 GVW Class) vehicles



Wireless Control Standard

All Meyer gas model spreaders feature a fully integrated wireless controller that allows you to start and choke your engine as well as engage your drive system.

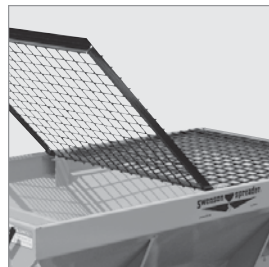

Top Screens/ Inverted V

Our standard drop n loc top screens break-up large clumps of material which can cause damage to the drag chain and reduce performance. The Inverted V design helps material from bridging and slowing down the conveyor.



Fork Pockets (PolyHawk and MDV)

Patented built-in fork pockets make it easy for any forklift to remove the spreader for maintenance or off season storage (standard).

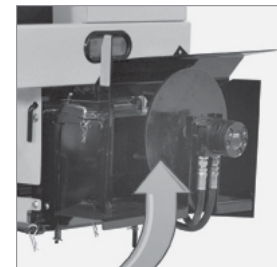

Swing Up Spinner (PolyHawk only)

Our no-tools-required swing up spinner easily swings up and out of the way for ease of storing the unit flat on saw horses. In addition, you can easily unload any material left in the hopper by simply swinging up the spinner and running the conveyor.

INSERT HOPPER SPREADERS – MDV AND POLYHAWK

MDV Specifications

Model	Part #	Hopper Length	Capacity	Weight	Height	Width	Length	Hopper	Operating System	Mounting Method	Flow Rate	Conveyor Type
MDV-944 B&S-MS	63945	9 ft	4.0 cu yd	1410 lbs	40"	70"	127"	Mild Steel	10.5hp B&S Gas	Part #62562	N/A	Drag Chain
MDV-944 B&S-SS	63948	9 ft	4.0 cy yd	1410 lbs	40"	70"	127"	Stainless Steel	10.5hp B&S Gas	Part #62562	N/A	Drag Chain
MDV-944 Honda-MS	63946	9 ft	4.0 cu yd	1410 lbs	40"	70"	127"	Mild Steel	11.0hp Honda Gas	Part #62562	N/A	Drag Chain
MDV-944 Honda-SS	63949	9 ft	4.0 cu yd	1410 lbs	40"	70"	127"	Stainless Steel	11.0hp Honda Gas	Part #62562	N/A	Drag Chain
MDV-944 Hydraulic-MS	63947	9 ft	4.0 cu yd	1250 lbs	40"	70"	127"	Mild Steel	Central Hydraulics	Part #62562	15 GPM @ 1,500 PSI (max)	Drag Chain
MDV-944 Hydraulic-SS	63950	9 ft	4.0 cu yd	1250 lbs	40"	70"	127"	Stainless Steel	Central Hydraulics	Part #62562	15 GPM @ 1,500 PSI (max)	Drag Chain
MDV-1044 B&S-MS	63951	10 ft	4.5 cu yd	1570 lbs	44"	70"	139"	Mild Steel	10.5hp B&S Gas	Part #62562	N/A	Drag Chain
MDV-1044 B&S-SS	63954	10 ft	4.5 cu yd	1570 lbs	44"	70"	139"	Stainless Steel	10.5hp B&S Gas	Part #62562	N/A	Drag Chain
MDV-1044 Honda-MS	63952	10 ft	4.5 cu yd	1570 lbs	44"	70"	139"	Mild Steel	11.0hp Honda Gas	Part #62562	N/A	Drag Chain
MDV-1044 Honda-SS	63955	10 ft	4.5 cu yd	1570 lbs	44"	70"	139"	Stainless Steel	11.0hp Honda Gas	Part #62562	N/A	Drag Chain
MDV-1044 Hydraulic-MS	63953	10 ft	4.5 cu yd	1426 lbs	44"	70"	139"	Mild Steel	Central Hydraulics	Part #62562	15 GPM @ 1,500 PSI (max)	Drag Chain
MDV-1044 Hydraulic-SS	63956	10 ft	4.5 cu yd	1426 lbs	44"	70"	139"	Stainless Steel	Central Hydraulics	Part #62562	15 GPM @ 1,500 PSI (max)	Drag Chain
MDV-944 Hydraulic Auger	63398	9 ft	4.0 cu yd	1200 lbs	44"	70"	127"	Stainless Steel	Central Hydraulics	Part #62562	15 GPM @ 1,500 PSI (max)	Auger
MDV-1044 Hydraulic Auger	63399	10 ft	4.5 cu yd	1360 lbs	44"	70"	139"	Stainless Steel	Central Hydraulics	Part #62562	15 GPM @ 1,500 PSI (max)	Auger

MDV Accessories

	MDV-944 Carbon 10.5HP B&S	MDV-944 Carbon 11HP Honda	MDV-944 Carbon 10.5HP B&S	MDV-1044 Carbon 11HP Honda	MDV-944 SS 10.5HP B&S	MDV-944 SS 11HP Honda	MDV-944 SS Hydr.	MDV-944 SS Hydr.	MDV-1044 SS 10.5HP B&S	MDV-1044 SS 11HP Honda	MDV-1044 SS Hydr.	MDV-1044 SS Hydr.	MDV-1044 Carbon Hydr.
Wireless Controller Package (Gas)	63688	63688	N/A	63688	63688	63688	N/A	N/A	63688	63688	N/A	N/A	N/A
Chain Oiler	62126	62126	62126	62126	62126	62126	62126	62126	62126	62126	62126	62126	62126
12" Side Extensions	64127	64127	64127	64129	64129	64128	64128	64128	64130	64130	64130	64130	64129
60 Gal. MDV Pre-Wet System (2-30 gal.)	64131	64131	64131	64131	64131	64131	64131	64131	64131	64131	64131	64131	64131
Vibrator Kit	63390	63390	63390	63390	63390	63390	63390	63390	63390	63390	63390	63390	63390

PolyHawk Specifications

Model	Part #	Hopper Length	Capacity	Weight	Height	Width	Length	Hopper	Operating System	Mounting Method	Conveyor Type
PolyHawk PV B&S (10.5 hp)	63898	8 ft.	2.0 cu. yd	850 lbs	35"	50"	114"	96"	4 cycle B&S gas	Part #62562	Drag Chain
PolyHawk PV Honda (11 hp)	63899	8 ft.	2.0 cu. yd	850 lbs	35"	50"	114"	96"	4 cycle Honda gas	Part #62562	Drag Chain
PolyHawk PV Electric	63900	8 ft.	2.0 cu. yd	855 lbs	35"	50"	114"	96"	Electric	Part #62562	Drag Chain
PolyHawk PV Ice Hawk	63393	8 ft.	2.0 cu. yd	865 lbs	35"	50"	114"	96"	Engine over Hydraulic	Part #62562	Drag Chain
PolyHawk PV Central Hydraulic	63901	8 ft.	2.0 cu. yd	776 lbs	35'	50"	114'	96'	Central Hydraulics	Part #62562	Drag Chain

PolyHawk Accessories

	8 Ft Poly Electric	8 Ft Poly 10.5HP B&S	8 Ft Poly 11HP Honda	8 Ft Poly Eng. Over Hydr.	8 Ft Poly Hydr.
Wireless Controller Package	63930	63688	63688	N/A	N/A
Vibrator Kit	63390	63390	63390	63390	63390
PolyHawk Tarp Kit	63684	63684	63684	63684	63684

DUMP TRUCK SPREADERS – UTG AND RTG



UTG – Under Tailgate Spreader

- Designed to mount below all standard dump body tailgates
- Available in two powerful drive systems; a high performance, low maintenance Direct Drive or a heavy duty Gearbox Drive
- Adjustable spinner frame minimizes spinner clearance
- Equipped with separate hydraulic motors for the auger and spinner to allow for independent control of each function
- Available in carbon or stainless steel
- Available in 88" and 96" lengths
- Spread widths from 4 to 40 feet
- Spreads sand, salt or mixed material
- 1 year warranty
- For dump body (5-6-7 GVW Class)

RTG – Replaceable Tailgate Spreader

- Designed to replace the standard dump body tailgate
- Equipped with separate hydraulic motors for the auger and the spinner for independent control of each function
- Single 6" auger with continuous filtering discharges approximately 5.0 lbs/rev.
- Polyurethane spinner disc to extend the spinner life
- Available in carbon or stainless steel
- Available in 88" length
- Spread widths from 4 to 40 feet
- Spreads sand, salt or mixed material
- 1 year warranty
- For dump body (5-6-7 GVW Class)

SPREADERS/
ACCESSORIES



Safety Interlock Systems

Our exclusive safety interlock system disables the auger during clean out and maintenance operations for optimum safety.



Top and Bottom Door Clean Out

Provides quick and easy access for maintenance operations after use and makes it easier to clean prior to off-season storage.

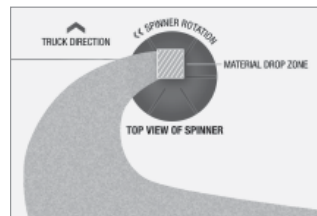
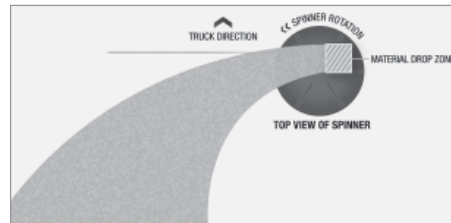

Driver or Center Discharge

Precisely controls the delivery and reduces the amount of material needed.

Driver Discharge = Street Applications

Center Discharge =

Parking Lot Applications



18" Poly Spinner

Constructed using long-life polyurethane. Designed to provide maximum material flow with precise spread patterns.

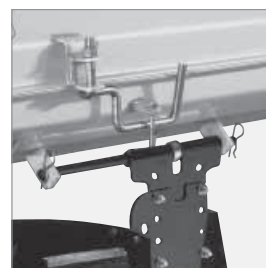

Spinner Stabilization Kit

Keeps spinner parallel to the road to maintain a consistent spread pattern.

DUMP TRUCK SPREADERS – UTG AND RTG

UTG Specifications

Model	Part #	Hopper Length	Capacity	Weight	Height	Width	Depth	Hopper	Operating System
UTG Direct Drive-MS	62210	N/A	N/A	510 lbs	19"	88"	18"	Mild Steel	Hydraulic
UTG Direct Drive-SS	62266	N/A	N/A	510 lbs	19"	88"	18"	Stainless Steel	Hydraulic
UTG Direct Drive-MS	63545	N/A	N/A	540 lbs	19"	96"	18"	Mild Steel	Hydraulic
UTG Direct Drive-SS	63546	N/A	N/A	540 lbs	19"	96"	18"	Stainless Steel	Hydraulic
UTG Gear Drive-MS	63547	N/A	N/A	571 lbs	19"	96"	18"	Mild Steel	Hydraulic
UTG Gear Drive-SS	63548	N/A	N/A	571 lbs	19"	96"	18"	Stainless Steel	Hydraulic
UTG CD Electric	63902	N/A	N/A	450 lbs	19"	96"	18"	Stainless Steel	Dual Electric Motor
UTG DD Electric	63903	N/A	N/A	450 lbs	19"	96"	18"	Stainless Steel	Dual Electric Motor
UTG CD Electric	63904	N/A	N/A	450 lbs	19"	96"	18"	Mild Steel	Dual Electric Motor
UTG DD Electric	63905	N/A	N/A	450 lbs	19"	96"	18"	Mild Steel	Dual Electric Motor

RTG Specifications

Model	Part #	Hopper Length	Capacity	Weight	Height	Width	Depth	Hopper	Operating System
RTG-MS	62212	N/A	N/A	550 lbs	23"	88"	16.5"	Mild Steel	Hydraulic
RTG-SS	62566	N/A	N/A	550 lbs	23"	88"	16.5"	Stainless Steel	Hydraulic
RTG CD Electric	63906	N/A	N/A	450 lbs	23"	88"	16.5"	Stainless Steel	Dual Electric Motors
RTG CD Electric	63907	N/A	N/A	540 lbs	23"	96"	16.5"	Stainless Steel	Dual Electric Motors
RTG CD Electric	63908	N/A	N/A	450 lbs	23"	88"	16.5"	Mild Steel	Dual Electric Motors
RTG CD Electric	63909	N/A	N/A	540 lbs	23"	96"	16.5"	Mild Steel	Dual Electric Motors

UTG and RTG Accessories

DESCRIPTION	UTG	RTG
Control Valve (Hydraulic Units Only)	62213	62213
Central Hose Kit (Hydraulic Units Only)	62214	62214
Central Pump Kit (Hydraulic Units Only)	61199	61199
Central 7 Gal Tank Kit (Hydraulic Units Only)	61193	61193
135 Gal UTG Pre-Wet System	63921	N/A
Dielectric Grease	15632	15632
Paint Yellow Spray (12/case)	08677	08677
Paint Yellow Cans (4/1qt.)	08755	08755
Paint Black Spray (12/case)	08676	08676
Paint White Primer Spray (12/case)	08841	08841

NOTES

DUMP TRUCK CROSSOVER CONVEYOR

TAILGATE CROSSOVER CONVEYOR

- Versatile four-season use
- Most efficient method of distributing granular or asphalt material on the market
- Uses include shouldering, filling a ditch, patching asphalt or spreading sand
- Saves labor, time and material
- Mounts quickly and easily underneath your dump body's tailgate
- Driver and Passenger side feedgates allow material to be discharged from either side
- Replaceable rubber chain shields run the full length of the trough to minimize material build up in the conveyor chain.
- Hinged top cover makes dump truck functional during non spreading operations

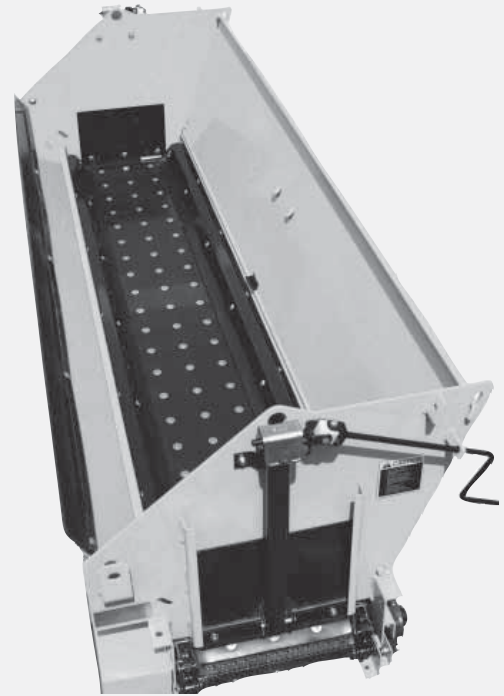

SPREADERS/
ACCESSORIES



High Temperature, Belt-Over Chain Conveyor

Makes dump truck functional during non-spreading activities.

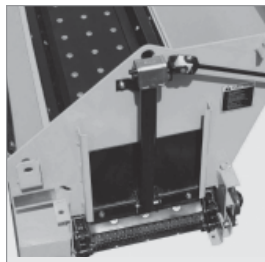

Screw-Type Gate Jacks

Allows material output adjustment when loaded.

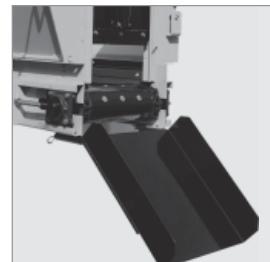

Standard 24-inch Extension

Can be mounted on either side for optimal material flow.



Optional Spinner Attachment

Available for snow and ice control.
Part #63959

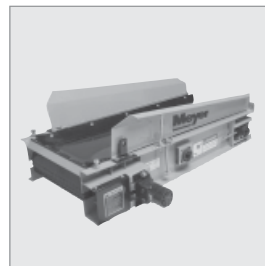

Optional 4' Motorized Conveyor Extension

Gives you extra reach for ditch filling or hard to reach locations.
Part #63960

ANTI-ICERS

ANTI-ICERS

- 295 gallon or 550 gallon tanks available
- Designed to provide onboard pre-wetting capability
- Pre-wetting allows the material to more quickly form a brine and stay on the road better
- Cab mounted variable speed controller adjusts the output and allows the operator to start/stop the spray pump
- Audible alarm and indicator lights alert operators of low system pressure, preventing pump damage
- Corrosion resistant stainless steel enclosure protects the pump assembly from mechanical damage (hydraulic unit only)
- Nozzles are designed to resist corrosion and evenly treat material



Shown with 295 gallon unit

PV/MDV Options

- Designed to mount on the left and right side of the PV/MDV series spreaders
- Tank is configured to nest along the sides of the spreader at the rear
- Mounting brackets attach all components to the hopper to keep the system together when spreader is removed from the vehicle



50-foot Spray Reel - Standard

Allows anti-icing in areas that vehicles can't reach such as sidewalks and steps.



Low Profile Pancake Tank Design

Improves visibility when driving and parking

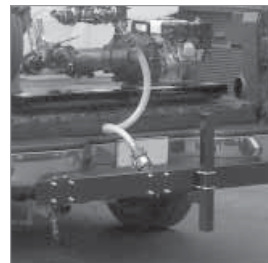

Quick Coupled Spray Bar

Allows liquid to be unloaded quickly into a transfer tank or storage container.



In-Line Flow Meter

Lets you chose the correct liquid application rate to meet your needs.

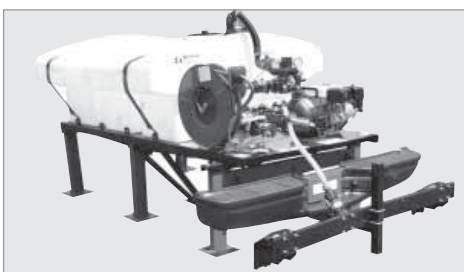

Self Storing Leg Stands

Provide for fast removal and storage of spray system

SPREADER ACCESSORIES – THE BIG YELLOW BOX



The Big Yellow Box

- Perfect for storing sand, rock salt, garage items, sports equipment or trash
 - 32"W x 23"D x 30"H
 - 8 cubic feet of storage
 - Molded, in-lid stop for double walled reinforced lid
 - Non-rusting, concealed, durable nylon rod hinge
 - Extra strength ribbed side
 - Water resistant
 - Lockable stainless steel paddle latch (optional)
- Part #32403

SPREADERS/
ACCESSORIES



Stackable

When space is at a premium, simply stack the Big Yellow Box to conserve space or for off season storage.



Fork Pockets Standard

When the load gets to heavy, all Big Yellow Boxes can be lifted using conventional lift trucks with the built-in fork pockets.



Perfect for Pool or Deck Storage



Use to Organize Garages

SPREADER ACCESSORIES

TAILGATE SPREADERS Mini - Mate - Blasters

Removable Hopper Screen – Allows you to screen material prior to filling the hopper to break-up clumps which can cause damage to the auger and reduce performance. Available in 2" x 2" or 1/2" x 1/2" mesh.
Part #34700 (Blaster Series) 2" X 2" Mesh
Part #34701 (Blaster Series) 1/2" X 1/2" Mesh



Mini Jr. Salt Screen and Built-in Bag Cutter – Allows you to screen material prior to filling the hopper to break-up clumps which can cause damage to the auger and reduce performance. Comes standard with a built-in cutter to open bags of salt. Screens come as per each, are easily installed and come with instructions. Meyer's Mini Jr. Screen is installed easily, come per each, with instructions, and hardware for a convenient install.
Part #36600 (Mini Series)



Mate Salt Screen – Allows you to screen material prior to filling the hopper to break-up clumps which can cause damage to the auger and reduce performance. The screen can be taken on and off without tools. Easy to install and comes with instructions and installation hardware.
Part #38260 (Mate)



Flow Gate Control – Controls the amount of material needed for a specific application. Provides manual adjustment of material flow to the spinner.
Part #34800 (Blaster Series)



Motor Guard and Integrated Storage Stand – Universal bolt-on accessory for motor protection. It also serves as a convenient off storage stand when spreader is not attached to a vehicle.
Part #36407 (Blaster and Mini Series)



Mate Motor Guard – Powder coated guard comes ready to install and inserts into a 2" receiver hitch. Comes as one unit and includes all mounting hardware and instructions for quick installation.
Part #38250 (Mate)



Sand/Salt Vibrator Kit (available option for models 350 and 750) – Standard on 350S and 750S models, lets you spread a 50/50 blend of rock salt and sand or sand only. Includes extended auger, vibrator, vibrator mounting plate, baffle plate and vibrator harness.
Part #34600 (Blaster Series)



Spreader Controller – The most reliable and convenient controller on the market, this lightweight and compact unit comes standard with many easy-to-use, performance enhancing features such as:



- (a) **Auto Spinner Stop Mode** – when selected, the spinner automatically stops when the brake is depressed for five seconds, saving salt.
- (b) **Auto Vibrate Mode** – when selected, the vibrator will automatically cycle every 60 seconds; this keeps materials agitated and ready for application.

Includes convenient features such as back-lit controls for visual clarity at night, and a variable-speed dial that controls spinner speed. If the controller senses that the motor is not operating, it automatically shuts down the system allowing you to inspect the system. Comes standard with easy-to-replace automotive-type fuses. Requires minimal installation and comes with all mounting hardware and instructions for easy installation.
Part #22800 (Blaster – Mini and Mate Series)

3-Point Hitch Mounting – Adapts the Meyer 240, Blaster 350 and Mini to any standard 3-point hitch configuration. Perfect for golf courses, universities, institutions and agricultural applications. Mounts easily and comes with instructions and hardware.
Part #38200 (Mate)
Part #36500 (240, Blaster 350 and Mini)



EZ-Swing Tailgate Assembly – Allows the empty Mate to swing freely from the tailgate. Operator has full access to the tailgate and vehicle bed. The Mate EZ-Swing mounting comes per each (1), with instructions and hardware for installation.
Part #38010 (Mate)

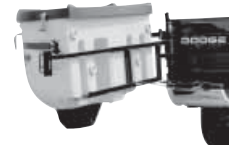

Spreader Rear Work Lights – Meyer offers two options for rear lighting for all spreaders. Each option comes with a work light and a brake light.

a) **LED Rear Light Package** – The heavy-duty industrial LED work light mounts conveniently to any rear location and brightens up the rear of the truck. The light is fully adjustable and plugs in to a standard trailer hitch power cord.

b) **Halogen Rear Light Package** – The lighter-duty halogen work light conveniently mounts to any rear location and brightens up the rear of the truck. The light is fully adjustable and plugs in to a standard trailer hitch power cord.

Both options include an integrated rear brake light that works in conjunction with the vehicle's brake lights. The LED brake lights install conveniently on any rear tailgate mounted spreader. Each kit comes fully assembled with mounting hardware and instructions.
Part #34610 LED Rear Light Package
Part #34609 Halogen Rear Light Package

SPREADER ACCESSORIES (CONT.)

WALK-BEHIND PUSH SPREADERS - HOTSHOTS

Weather Cover (Shower Cap) — This custom fitted see-through weather cap snugly fits on the Hotshot hoppers providing maximum protection from the elements, keeping your materials dry and free flowing.
Part #PSB14606 Hotshot
Part #PSB14606 Hotshot HD
Part #PSB14872 Hotshot 100



Hotshot Salt Deflector Shield — Allows a user to place salt exactly where it needs to go without damaging expensive landscaping. Deflectors come as per each and are easily installed.
Part #PSB15464 Hotshot
Part #PSB15972 Hotshot HD
Part #PSB16096 Hotshot 100

Hotshot Internal Screen — Screens material while filling the hopper in order to breakup clumps which can cause damage to the auger and reduce performance. Meyer's Hotshots come standard with internal spreader screens for all models. Replaceable screens come as per each, are easily installed and come with instructions for quick and easy installation.
Part #PSB14603 Hotshot
Part #PSB14603 Hotshot HD
Part #PSB14863 Hotshot 100

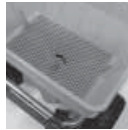

Tarp Kit (PolyHawk and PV) — Designed to prevent additional moisture or debris from being introduced into your PolyHawk hopper. The rugged, one piece, fitted tarp is waterproof and has ultraviolet protection for long life. Durable rubber tarp straps can be quickly removed for hopper filling. The Tarp Kit includes all parts required to mount to a PolyHawk spreader.
Part #63684 (PolyHawk)
Part #62546 (PV - 7'8')



Nylon Strap Mounting Kit (LPV, PV, PolyHawk and MDV) — Our nylon strap mounting kits are designed to hold up against harsh winter elements. Our mounting Kit includes four heavy duty 2" nylon ratcheting straps and hardware to quickly mount your PV.
Part #62562



Spill Shield (PV) — Protect the front of your vehicle and minimize waste with our 10" spill shield. Our bolt on spill shield prevents material loss while loading the unit by directing the material back into the hopper.
Part #63922 Carbon Steel Spill Shield
Part #63923 Stainless Steel Spill Shield

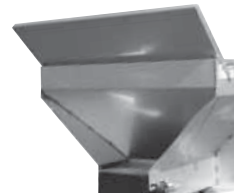

Spill Shield (MDV) — Protect the front of your vehicle and minimize waste with our 10" spill shield. Our spill shield prevents material loss while loading the unit by directing the material back into the hopper.
Part #63927 Carbon Steel Spill Shield
Part #63928 Stainless Steel Spill Shield

Six Inch Side Extension (PV) — Our 6" tall side extensions add approximately 0.66 cubic yards of capacity to the spreader. Side extensions easily bolt together allowing you to add capacity to your 7' or 8' steel PV without any welding.
Part #63924 7ft. Carbon Steel PV
Part #63925 7ft. Stainless Steel PV
Part #63895 8ft. Carbon Steel PV
Part #63926 8ft. Stainless Steel PV



SPREADERS: LPV - PV - POLYHAWK - MDV

Liquid Pre-Wet System (PV) — Pre-wetting salt prior to spreading can reduce salt consumption by 20 to 30% and reduce the time to achieve bare pavement from 20 hours to 2 hours. Our fully-integrated pre-wetting system includes two fifteen gallon tanks (one for each side of the spreader) and the mounting brackets to install the pre-wet system. The system includes a cab-mounted variable speed controller for adjusting liquid output. Two variable orifice rubber nozzles are provided to evenly treat granular material as it falls onto the spinner disc.
Part #63938



Liquid Pre-Wet System (MDV) — Pre-wetting salt prior to spreading can reduce salt consumption by 20 to 30% and reduce the time to achieve bare pavement from 20 hours to 2 hours. Our fully integrated pre-wetting system includes two thirty-gallon tanks (one for each side of the spreader) and the mounting brackets to install the pre-wet system. The system includes a cab-mounted variable speed controller for adjusting liquid output. Two variable orifice rubber nozzles are provided to evenly treat granular material as it falls onto the spinner disc.
Part #64131

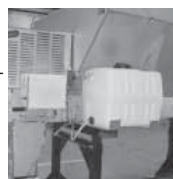

Twelve Inch Side Extension (MDV) — Our 12" tall side extensions add approximately 2 cubic yards of capacity to the spreader. The side extensions easily bolt together allowing you to add capacity to your 9' or 10' steel MDV without any welding.
Part #64127 9ft. Carbon Steel MDV
Part #64128 9ft. Stainless Steel MDV
Part #64129 10ft. Carbon Steel MDV
Part #64130 10ft. Stainless Steel MDV

Six-Inch Side Extension (LPV) — Our 6" tall side extensions add approximately 0.44 cubic yards of capacity to the spreader. The side extensions easily bolt together allowing you to add capacity to your 8' stainless steel LPV without any welding.
Part #63538

SPREADER ACCESSORIES (CONT.)

Battery Harness Kit (PV, PolyHawk, LPV and MDV)

– Eliminate the need for an auxiliary battery. Meyer's Battery Harness Kit contains all the hardware necessary to utilize the power of your vehicle battery to drive your PV spreader. Designed to fit all truck sizes. Part #62565



Variable Speed (Wired) Controller System for Electric Spreader (Utility LPV, PolyHawk and LPV)

– Designed exclusively for the Meyer LPV electric drive, this rugged controller features a power on/off switch, blast switch and an auxiliary switch. The rheostat controller allows infinite adjustment of your conveyor and motor speeds. In the event of an overload or jam, two indicator lights will illuminate on the controller display board. Includes wiring harness. Part #63929

Variable Speed Standard (Wireless) Controller System for Electric Spreader (Utility LPV, Elec PolyHawk and LPV)

– The wireless variable speed controller features five speed control options and a blast option. In addition, you can engage the spinner and conveyor drive system with the remote controller. This compact controller easily fits in the palm of your hand and operates using the battery system in your vehicle. Includes complete hardware to install. Part #63930



Variable Speed (Wired) Controller System for Gas Spreader (Utility LPV, LPV, PV, MDV and PolyHawk)

– The control system mounts conveniently in the cab and is fully accessible by the operator. The unit features a blast function that surges the motor to 80 amps to shake loose salt clogs and break up clumps that may be blocking the spread pattern. Unit is easy to install and comes complete with marine-type connectors to ensure connectivity. Compatible with all Meyer 6.5hp, 10.5hp B&S and 11hp Honda gas driven spreaders. (Requires (1) 63167 Harness) Part #62334 Part #63167 (Harness)

Variable Speed Standard (Wireless) Controller System for Gas Spreader (Utility LPV, LPV, PV, MDV and PolyHawk)

– The Standard Gas Engine Wireless Controller Systems provides the same control of a wired controller, but in a wireless version! The hand held wireless transmitter allows you to control all the basic functions of your controller from up to 75 feet away! The receiver unit's sealed enclosure is vibration and waterproof for rugged durability. Requires stand-alone 12V spreader mounted battery (not included). Compatible with all Meyer 6.5hp, 10.5hp B&S and 11hp Honda gas driven spreaders. Standard System includes micro-sized remote control. Part #63688 (Standard Control)

Variable Speed Deluxe (Wireless) Controller System for Gas Spreader (Utility LPV, LPV, PV, PolyHawk and MDV)

– Our deluxe wireless system features a larger transmitter that fits comfortably in your hand and can be easily operated even when wearing bulky work gloves. In addition, the transmitter features a green LED display that illuminates when the conveyor is engaged to indicate that material is spreading. Requires a stand-alone 12V spreader mounted battery (not included). Compatible with all Meyer 6.5hp, 10.5hp B&S and 11hp Honda gas driven spreaders. Part #63934 (Deluxe Control)



Remote Control Transmitters Only (Replacement) – Meyer offers two remote control systems a Deluxe remote control and a Standard remote. The Deluxe remote is 3.5 times larger than the standard version. Both remote controls are compatible with either system. (Deluxe remote not available for Electric Spreaders)

Part #63755 (Standard remote Gas only)
Part #63897 (Deluxe remote Gas only)
Part #63931 (Standard remote Electric only)

Sure Flow Vibrator (LPV, PV, PolyHawk and MDV)

– Meyer's Sure Flow Vibrator Kit delivers 200 pounds of force to break up even the most stubborn materials. Included in the kit is everything you need to mount the vibrator to your spreader including all hardware, wiring and a mounting plate. Part #63390



DUMP TRUCK SPREADERS: RTG, UTG AND STCC

Light Kit (STCC) – Increase your visibility to vehicles behind you with this Light Kit specifically designed for your Meyer STCC. Includes stop, turn and tail lights, three light cluster, junction box and both halves of the 7 pin trailer plug. All lights are installed and pre-wired at factory. Part #63957



Reversing Valve (STCC) – Want to easily spread material to the right or left? This easy to install reversing valve allows the operator to select conveyor direction at the rear of truck. Includes valve, mounting brackets and hose to mount to spreader. Part #63958



Spinner Assembly Kit (STCC) – Convert your STCC to a snow and ice control machine. The Spinner Assembly Kit includes everything you need to spread sand or sand/salt mix. Includes an 18" polyurethane spinner disc driven by a direct coupled top mounted hydraulic motor for improved control and spreading capabilities. Can be installed on right or left end of spreader to satisfy various spreading requirements. Not recommended for straight salt applications due to high output volume. Part #63959



SPREADER ACCESSORIES (CONT.)

Four Foot Motorized Extension (STCC) –

Extends material drop location approximately four feet from end of cross conveyor which improves the effectiveness of the shouldering and trench filling applications. Fold up design for easy transportation and storage between uses. Lightweight Straight belt conveyor runs off main conveyor circuit to eliminate extra hydraulics on vehicle.
Part #63960



Control Valve (UTG and RTG) - Hydraulic Only – This control valve allows for independent control of both the spinner and auger motors for precise material spreading. Requires central hydraulic system on your vehicle.
Part #62213



Central Hydraulic Hose Kit (UTG and RTG Hydraulic and STCC) – This hose kit includes all of the hydraulic hoses, fittings and hardware for connecting a UTG, RTG or STCC unit to the central hydraulic system of your truck. For 9 to 15 foot dump bed lengths.
Part #62214



Central Hydraulic Pump Kit (UTG and RTG Hydraulic and STCC) – This stand-alone pump is designed to connect to the vehicle's transmission through a 24" shaft (included). All necessary mounting brackets, Suction Hose and fittings, U-Joints and hardware included. Requires 7 gallon Tank Kit (#61193).
Part #61199



Central Hydraulic 7 Gallon Tank Kit (UTG and RTG Hydraulic and STCC) – This 7 gallon tank reservoir connects to the Pump Kit (61199) and is designed to provide oil flow for either the Meyer's UTG, RTG or STCC.
Part #61193



Meyer Sno-Flo Industrial Paint – Our specially formulated paint is designed to withstand the harsh operational environment. Meyer Yellow, Black and White Primer is available in aerosol spray cans (12/case) and Meyer Yellow is available in 1 quart cans (12 case) and a convenient 4 pack case that can be shipped via UPS.



Part #08755 Brush Yellow (4/1qt.cans/UPS)
Part #08677 Spray Case Yellow (12cans/case)
Part #08676 Spray Case Black (12cans/case)
Part #08841 Spray Case White Primer (12cans/case)

Meyer Dielectric Grease – Specially formulated to coat and protect electrical connections from deteriorating elements such as salt and road grime. It is recommended to coat all electrical connections prior to winter and each time you re-connect to ensure optimal performance. Grease comes per each, 2.7oz tube.
Part #15632



NOTES

SPREADERS/
ACCESSORIES

SPREADER ACCESSORIES CHART

Tailgate Spreaders – Spreader Accessories and Common Attachments

DESCRIPTION	240 Series	Mini Series	Mate Series	Blaster Series
Top Screens	N/A	36600	38260	34700 (2"); 34701 (1/2")
Motor/Guard	N/A	36407	36407	36407
Receiver Hitch Motor Gd.	N/A	N/A	38250	N/A
Flow Gate Control	N/A	N/A	38037	34800
Rear Light and Brake Kit - LED	34610	34610	34610	34610
Rear Light and Brake Kit - Halogen	34609	34609	34609	34609
Controller (Meyer)	34417	22800	22800	22800
Controller	34417	22808	22808	22808
Sand/Salt Vibrator Kit	N/A	N/A	38070	34600
Dielectric Grease	15632	15632	15632	15632
3 Pt. Hitch Mounting	36500	36500	38200	36500 (350)
Receiver Hitch Mnt.	Included in unit	36404	N/A	35001 (350) 35010 (750)
Swing/Hinged Mount	N/A	N/A	38010	35500 (750)
Dump Truck Mount	N/A	N/A	N/A	35300 (750)
Utility Vehicle Mount	N/A	N/A	N/A	35002 (350)
Flat Bed Mounting	N/A	N/A	N/A	35400 (750)
Fixed Mount T-Gate	N/A	N/A	N/A	35200 (750)
Paint Yellow Spray (12/case)	08677	08677	08677	08677
Paint Yellow Cans (4/1qt.)	08755	08755	08755	08755
Paint Black Spray (12/case)	08676	08676	08676	08676
Paint White Primer Spray (12/case)	08841	08841	08841	08841

SPREADERS/
ACCESSORIES

NOTES

SPREADER ACCESSORIES CHART (CONT.)

LPV, PV, PolyHawk and MDV – Spreader Accessories and Common / Fast Moving Parts

GENERAL DESCRIPTION	ALL LPVS	8' LPV	7' PV CS	7' PV SS	8' PV CS	8' PV SS	PolyHawk	MDV CS	MDV SS
Battery Harness Kit	62565	62565	62565	62565	62565	62565	62565	62565	62565
Liquid Pre-Wet Systems PV's and MDV's	N/A	N/A	63938	63938	63938	63938	N/A	64131	64131
Spill Shield Carbon Spreaders	N/A	N/A	63922	N/A	63922	N/A	N/A	63927	63928
Spill Shield Stainless Spreaders	N/A	N/A	N/A	63923	N/A	63923	N/A	N/A	N/A
Tarp Cover Kit	N/A	N/A	62546	62546	62546	62546	63684	N/A	N/A
Nylon Strap Mounting Kit	62562	62562	62562	62562	62562	62562	62562	62562	62562
12" Side Extensions 9' Carbon MDV	N/A	N/A	N/A	N/A	N/A	N/A	N/A	64127	N/A
12" Side Extensions 9' Stainless MDV	N/A	N/A	N/A	N/A	N/A	N/A	N/A	N/A	64128
12" Side Extensions 10' Carbon MDV	N/A	N/A	N/A	N/A	N/A	N/A	N/A	64129	N/A
12" Side Extensions 10' Stainless MDV	N/A	N/A	N/A	N/A	N/A	N/A	N/A	N/A	64130
6" Side Extensions - LPV and PV	N/A	63538	63924	63925	63895	63926	N/A	N/A	N/A
Variable Spd. Std. (Wireless) Controller Sys Electric	63930	63930	N/A	N/A	N/A	N/A	63930	N/A	N/A
Variable Spd. (Wired) Controller Sys Electric	63929	63929	N/A	N/A	N/A	N/A	63929	N/A	N/A
Variable Spd. (Wired) Control Sys Gas (req 63167)	N/A	N/A	62334	62334	62334	62334	62334	62334	62334
Harness Kit for 62334 Controller	63167	63167	63167	63167	63167	63167	63167	63167	63167
Variable Spd. Std. (Wireless) Controller Sys Gas	63688	63688	63688	63688	63688	63688	63688	63688	63688
Variable Spd. Dlx. (Wireless) Controller Sys Gas	63934	63934	63934	63934	63934	63934	63934	63934	63934
Remote Control Only Elec Std. (Small)	63931	63931	N/A	N/A	N/A	N/A	63931	N/A	N/A
Remote Control Only Gas Std. (Small)	63755	63755	63755	63755	63755	63755	63755	63755	63755
Remote Control Only Gas Dlx. (Large)	63897	63897	63897	63897	63897	63897	63897	63897	63897
Sure Flow Vibrator Kit	63390	63390	63390	63390	63390	63390	63390	63390	63390
Dielectric Grease	15632	15632	15632	15632	15632	15632	15632	15632	15632
Automated Chain Oiler (gravity-fed)	62126	62126	62126	62126	62126	62126	62126	62126	62126
Spinner Disc Replacement (disc only)	62146	62146	62146	62146	62146	62146	62146	62146	62146
Paint Yellow Spray (12/case)	08677	08677	08677	08677	08677	08677	08677	08677	08677
Paint Yellow Cans (4/1qt.)	08755	08755	08755	08755	08755	08755	08755	08755	08755
Paint Black Spray (12/case)	08676	08676	08676	08676	08676	08676	08676	08676	08676
Paint White Primer Spray (12/case)	08841	08841	08841	08841	08841	08841	08841	08841	08841
Paint White Primer Spray (12/case)	08841	08841	08841	08841	08841	08841	08841	08841	08841

KEY:

- LPV = Low Profile V-Box
- PVCS = Pick-up Truck V-Box – Carbon Steel
- PVSS = Pick-up Truck V-Box – Stainless Steel
- MDVCS = Medium Duty V-Box – Carbon Steel
- MDVSS = Medium Duty V-Box – Stainless Steel

SPREADER ACCESSORIES CHART (CONT.)

Spreader Accessories – Push Walk Behind Spreaders

DESCRIPTION	Hotshot	Hotshot HD	Hotshot 100
Internal Screen	PSB14603	PSB14603	PSB14863
Deflector Shield Spreader	PSB15464	PSB15972	PSB16096
Hopper Cover Spreader	PSB14606	PSB14606	PSB14872

Note: Items are standard equipment when purchased - replacement only

STCC, UTG and RTG – Dump Truck Spreader Accessories

DESCRIPTION	STCC	UTG	RTG
Rear Light Bar Kit	63957	N/A	N/A
Reversing Valve	63958	N/A	N/A
Spinner ACY Kit	63959	N/A	N/A
Four Foot Motorized Ext.	63960	N/A	N/A
Control Valve Hyd Only	N/A	62213	62213
Central Hyd Hose Kit	62214	62214	62214
Central Hyd Pump Kit	61199	61199	61199
Central Hyd 7 Gal Tank Kit	61193	61193	61193
Dielectric Grease	15632	15632	15632
Paint Yellow Spray (12/case)	08677	08677	08677
Paint Yellow Cans (4/1qt.)	08755	08755	08755
Paint Black Spray (12/case)	08676	08676	08676
Paint White Primer Spray (12/case)	08841	08841	08841

SPREADERS/
ACCESSORIES

NOTES

INSERT DUMP BODY



INSERT DUMP BODY



2-Way Tailgate

Provides the needed flexibility for controlling material flow during dumping operations.

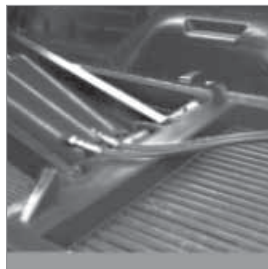

2-Wire Braided Hoses

Feature increased burst strength, while reducing wear at critical points.

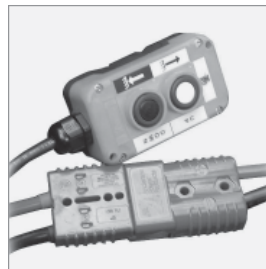

Monarch Power Unit w/Cabled Control

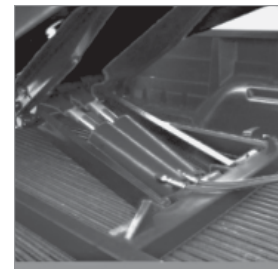

Twin Cylinder Hoist – 8' Bed

Increase lifting capacity while adding versatility.

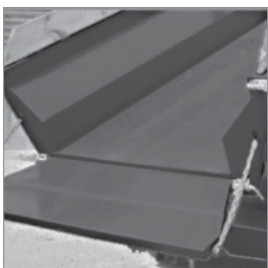

Powder Coated or Stainless Steel Construction

All frames are either powder coated with automotive style paint or made using stainless steel (depending on model) for a tough as nails finish and increased service life.



Single Piece Sides and Underbody Supports

Self locating underbody supports increase safety during maintenance and servicing operations.

TIMBREN

Timbren Suspension Enhancement Systems (SES)

To improve the ride and overall performance of your vehicle, Meyer offers Timbren Suspension Enhancement kits. Timbren suspension system works in conjunction with your vehicle's factory suspension system to provide added support in the front or rear of your vehicle. Timbren's rubber cushioned products reduce the harsh ride caused by adding leaf springs or helper springs. Timbren suspension kits come complete as a set (2) and include installation instructions. May require professional installation.



TIMBREN FRONT	TIMBREN REAR	YEAR	DESCRIPTION	MTG. TYPE	MTG. CARTON
CHEVROLET/GMC	PART NO.				
GMFC4	GMRCC	2004 TO 2007	COLORADO, CANYON	DRIVE PRO	18504
GMFK15C	GMRCK15D	2007	1500 SIERRA, SILVARADO - FRONT COIL SPRS	EZ PLUS	17165
GMFK35C	GMRCK25	1988 to 2000	K1500 PICKUP 4/WD	EZ PLUS	17119
GMFK25S	GMRCK25	1996 to 2000	K2500 4/WD	EZ PLUS	17119
GMFK35C	GMRCK25	1988 to 1998	K2500 4/WD	EZ PLUS	17119
GMFK25S	GMRCK35	1996 to 2000	K3500 4/WD	EZ PLUS	17119
GMFK35C	GMRCK35	1988 to 1998	K3500 4/WD	EZ PLUS	17119
GMFK35C	<i>GMRK10</i>	1992	BLAZER, JIMMY, SUBURBAN 4/WD	EZ PLUS	17119
GMFK35C	<i>GMRYT4</i>	1992 to 2000	YUKON, TAHOE 4/WD	EZ PLUS	17119
GMFK35C	<i>GMRSB4</i>	1993 to 1999	BLAZER, JIMMY, SUBURBAN 4/WD	EZ PLUS	17119
<i>GMFK35HDA</i>	<i>GMR35HDM</i>	1991 to 2003	HD 3500 2/WD 15,000 lb. G.V.W.R.	EZ PLUS	17127
GMFK15A	<i>GMRCK15S</i>	1999 to 2007	K1500 PICKUP 4/WD NOVEMBER FRAME CHANGE	EZ PLUS	17140
GMFK15A	<i>GMRYS4</i>	2000 to 2006	K1500 SUBURBAN/YUKON XL 4/WD	EZ PLUS	17140
GMFK15A	<i>GMRG25C</i>	2001 to 2006	K1500 TAHOE, YUKON 4/WD	EZ PLUS	17140
GMFK15A	<i>GMRG25C</i>	2002 to 2006	K1500 AVALANCHE 4/WD	EZ PLUS	17140
<i>GMFK15B</i>	<i>GMRYS4</i>	2007	K1500 PICKUP 4/WD NOVEMBER FRAME CHANGE	EZ PLUS	17165
<i>GMFK15B</i>	<i>GMRYS4</i>	2007	K1500 YUKON, SUBURBAN 4/WD	EZ PLUS	17165
GMFK25S	GMRCK25S	2001 to 2007	K1500 HD CREW CAB 4/WD	EZ PLUS	17139
GMFK25S	<i>GMRSB4S</i>	2002 to 2006	K2500 AVALANCHE 4/WD	EZ PLUS	17139
GMFK25S	<i>GMRSB4S</i>	2000 to 2007	K2500 SUBURBAN, YUKON XL	EZ PLUS	17139
GMFK25S	GMRCK25S	1999 to 2007	K2500 4/WD	EZ PLUS	17139
GMFK25S	GMRCK35S	1999 to 2007	K3500 4/WD	EZ PLUS	17139
GMFK25S	<i>GMRCK35C</i>	2003 to 2007	C2500 / C3500 PICKUP 2/WD	EZ PLUS	17139
<i>GMFK</i>	<i>GMRP30MH</i>	2003 to 2007	C4500 / C5500 4/WD 16,000 lb. G.V.W.R. 4/WD	EZ PLUS	17158
GMFS10	<i>GMR10A</i>	1983 to 1994	S-BLAZER / S-JIMMY 4/WD	CLASSIC	18056
GMFS10	<i>GMR10A</i>	1983 to 1993	S- PICK-UP 4/WD	CLASSIC	18056
GMFS10	<i>GMR10A</i>	1994	S- PICK-UP 4/WD	CLASSIC	18078
GMFK10	<i>GMRK10</i>	1981 to 1987	K-10 (V-10), BLAZER 4/WD	CLASSIC	17091
GMFK10	<i>GMRK10</i>	1981 to 1991	JIMMY, SUBURBAN 4/WD4	CLASSIC	17091
GMFK10	<i>GMRK10</i>	1981 to 1987	K-20 (V-20) PICKUP/ SUBURBAN 4/WD	CLASSIC	17091
GMFK10	<i>GMRK30</i>	1981 to 1987	K-30 (V-30) PICKUP 4/WD	CLASSIC	17091
GMFK35C	GMRCK25	1988 to 2000	K1500 PICKUP 4/WD	CLASSIC	17089
GMFK25S	GMRCK25	1996 to 2000	K2500 4/WD	CLASSIC	17089
GMFK35C	GMRCK25	1988 to 1998	K2500 4/WD	CLASSIC	17089
GMFK25S	GMRCK35	1996 to 2000	K3500 4/WD	CLASSIC	17089
GMFK35C	GMRCK35	1988 to 1998	K3500 4/WD	CLASSIC	17089
GMFK35C	<i>GMRK10</i>	1992	BLAZER, JIMMY, SUBURBAN 4/WD	CLASSIC	17089

ITEMS IN BOLD ARE STOCKED BY MEYER PRODUCTS. NON BOLD PART NUMBERS LISTED IN ITALICS ARE SPECIAL ORDER ONLY. PLEASE USE TIMBREN PART NUMBER WHEN ORDERING.

***= PROFESSIONAL INSTALLATION REQUIRED

TIMBREN (CONT.)

TIMBREN FRONT	TIMBREN REAR	YEAR	DESCRIPTION	MTG. TYPE	MTG. CARTON
GMFK35C	<i>GMRYT4</i>	1992 to 2000	YUKON, TAHOE 4/WD	CLASSIC	17089
GMFK35C	<i>GMRSB4</i>	1993 to 1999	BLAZER, JIMMY, SUBURBAN 4/WD	CLASSIC	17089
GMFC1588H	<i>GMRC25HD</i>	1988 to 2000	C2500 2/WD	CLASSIC	17094
GMFC1588H	GMRCK35	1988 to 2000	C3500 2/WD	CLASSIC	17094
GMF35HDA	<i>GMR35HDM</i>	1991 to 2003	HD 3500 2/WD 15,000 lb. G.V.W.R.	CLASSIC	17093
<i>GMFK15A</i>	GMRCK15S	1999 to 2007	K1500 PICKUP 4/WD NOVEMBER FRAME CHANGE	CLASSIC	17138
<i>GMFK15A</i>	<i>GMRYS4</i>	2000 to 2006	K1500 SUBURBAN/YUKON XL 4/WD	CLASSIC	17138
<i>GMFK15A</i>	<i>GMRG25C</i>	2001 to 2006	K1500 TAHOE / YUKON 4/WD	CLASSIC	17138
<i>GMFK15A</i>	<i>GMRG25C</i>	2002 to 2006	K1500 AVALANCHE 4/WD	CLASSIC	17138
GMFK25S	GMRCK25S	2001 to 2007	K1500 HD CREW CAB 4/WD	CLASSIC	17111
GMFK25S	<i>GMRSB4S</i>	2000 to 2007	K2500 SUBURBAN/YUKON XL 4/WD	CLASSIC	17111
GMFK25S	<i>GMRSB4S</i>	2000 to 2006	K2500 AVALANCHE 4W/D	CLASSIC	17111
GMFK25S	GMRCK25S	1999 to 2007	K2500 4/WD	CLASSIC	17111
GMFK25S	GMRCK35S	1999 to 2007	K3500 4/WD	CLASSIC	17111
GMFK25S	<i>GMRCK35C</i>	2003 to 2007	C2500/C3500 PICKUP 2/WD	CLASSIC	17111
GMFK10	<i>GMRK10</i>	1973 to 1987	K-10 (V-10) PICKUP 4/WD	CUSTOM	17078
GMFK10	<i>GMRK10</i>	1973 to 1991	K-5 BLAZER, JIMMY, SUBURBAN 4/WD	CUSTOM	17078
GMFK10	<i>GMRK10</i>	1973 to 1987	K-20 (V-20) PICKUP, SUBURBAN 4/WD	CUSTOM	17078
GMFK10	<i>GMRK30</i>	1973 to 1987	K-30 (V-30) PICKUP 4/WD	CUSTOM	17078
<i>TORTUN4</i>	<i>GMRW35</i>	1998 to 2006	W3500 2/WD	CUSTOM	17107
<i>TORTUN4</i>	<i>GMRW4A</i>	1998 to 2006	W4500 / W5500 2/WD	CUSTOM	17107
<i>GMFTK</i>	<i>GMRP30MH</i>	2003 to 2007	C4500 / C5500 2/WD 16,000 lb. G.V.W.R.	CUSTOM	17133
<i>GMFTK</i>	<i>GMRP30MH</i>	2003 to 2007	C4500 / C5500 2/WD 18,000 lb. to 19,000 lb. G.V.W.R.	CUSTOM	17133
<i>GMF55AWD</i>	<i>GMRTKM</i>	2005 to 2007	C4500 / C5500 4/WD 16,000 lb. G.V.W.R.	CUSTOM	17153
<i>GMF55AWD</i>	<i>GMRTKM</i>	2005 to 2007	C4500 / C5500 4/WD 18,000 lb. to 26,000 lb. G.V.W.R.	CUSTOM	17153
DODGE	PART NO.				
DF15004B	<i>DR1525H4</i>	2006 TO 2007	RAM 1500 06-07	EZ PLUS	17130
DDF1004	<i>DDR1004</i>	THRU 1996	DAKOTA 4/WD	CLASSIC	18060
DF3504BA	<i>DR150</i>	1972 to 1993	W150 / RAMCHARGER 4/WD	CLASSIC	17090
DF3504BA	<i>DR250</i>	1972 to 1993	W250 / W350 4/WD 4,000 lb. F.G.A.W.R.	CLASSIC	17090
DF3504BA	<i>DR3502</i>	1972 to 1993	W250 / W350 4/WD 4,500 lb. F.G.A.W.R.	CLASSIC	17099
DF25004B	DR1525H4	1994 to 2001	W1500 4/WD	CLASSIC	17103
DF15004C	DR2500CA	1999 to 2001	W1500 SPORT 4/WD	CLASSIC	17116
DF25004B	DR1525H4	1994 to 2002	W2500 and W3500 4/WD	CLASSIC	17104
DF25004B	DR3500	1994 to 1999	W2500 HD / W3500 4/WD	CLASSIC	17104
DF25004B	<i>DR3520</i>	2000 to 2002	W2500 HD / W3500 4/WD	CLASSIC	17104
DF25004B	<i>DR3520</i>	1999 to 2002	W2500 SPORT 4/WD	CLASSIC	17117
DF25004B	DR2500CA	2003 to 2007	W2500HD 4/WD	CLASSIC	17135
DF25004B	DR3500CA	2003 to 2007	W3500 4/WD	CLASSIC	17135
FORD	PART NO.				
FF1504H	FR250SDE	1992 to 1996	F150 PICKUP / BRONCO 4/WD	EZ PLUS	17126
FF1504H	<i>FAR001</i>	1992	BRONCO 3,800 lb. F.G.A.W.R. 4/WD	EZ PLUS	17126

ITEMS IN BOLD ARE STOCKED BY MEYER PRODUCTS. NON BOLD PART NUMBERS LISTED IN ITALICS ARE SPECIAL ORDER ONLY. PLEASE USE TIMBREN PART NUMBER WHEN ORDERING.

***= PROFESSIONAL INSTALLATION REQUIRED

TIMBREN (CONT.)

TIMBREN FRONT	TIMBREN REAR	YEAR	DESCRIPTION	MTG. TYPE	MTG. CARTON
FF2504A	FR250SDE	1992 to 1998	F250 4/WD	EZ PLUS	17125
FF3504A	FR350SDE	1992 to 1998	F350 4/WD	EZ PLUS	17128
FFSD	<i>FRSD</i>	1992 to 1998	F450 CAB CHASSIS 2/WD 15,000 lb. G.V.W.R.	EZ PLUS	17128
FF150974A	<i>FR1525HD</i>	1997 to 1999	F150 PICKUP 4/WD	EZ PLUS	17124
FF150974A	<i>FR1525HD</i>	1997 to 1999	F250 LD 4/WD 7,700 lb. G.V.W.R	EZ PLUS	17124
FF150974A	<i>FR1525HD</i>	2000 to 2003	F150 PICKUP 4/WD 7,700 lb. G.V.W.R	EZ PLUS	17124
<i>FF350SD4</i>	<i>FRFXC4</i>	2000 to 2006	EXCURSION 4/WD	EZ PLUS	17162
FF150974A	<i>FR1525HD</i>	2004 to 2007	F150 PICKUP 4/WD 8,200 lb. G.V.W.R (HERITAGE)	EZ PLUS	17141
FF150D ***	<i>FR150D</i>	2004 to 2007	F150 PICKUP 4/WD 8,200 lb. G.V.W.R (EXCL.HERITAGE)	EZ PLUS	17141
FF350SD4B	<i>FR150SDE</i>	1999 to 2000	F250 4/WD - WITH SNOWPLOW PREP. PACKAGE	EZ PLUS	17162
<i>FF350SD4</i>	<i>FR150SDE</i>	1999 to 2000	F250 4/WD - WITHOUT SNOWPLOW PREP. PACKAGE	EZ PLUS	17162
FF350SD4B	FR250SDE	2001 to 2007	F250 4/WD - WITH SNOWPLOW PREP. PACKAGE	EZ PLUS	17162
<i>FF350SDC</i>	<i>FR250SDF</i>	2005 to 2007	F250 4/WD - WITHOUT SNOWPLOW PREP. PACKAGE	EZ PLUS	17162
FF350SD4B	FR350SDE	1999 to 2004	F350 4/WD - WITH SNOWPLOW PREP. PACKAGE	EZ PLUS	17162
<i>FF350SD4</i>	FR350SDE	1999 to 2004	F350 4/WD - WITHOUT SNOWPLOW PREP. PACKAGE	EZ PLUS	17162
<i>FF350SDC</i>	<i>FR350SDF</i>	2005 to 2007	F350 4/WD	EZ PLUS	17162
FFSD4	<i>FRSD</i>	1999 to 2004	F450 and F550 2 OR 4/WD	EZ PLUS	17162
<i>FF550SDE</i>	<i>FRSD</i>	2005 to 2007	F450 and F550 2 OR 4/WD	EZ PLUS	17162
TOFTUN4	<i>URMDE</i>	2006 to 2007	LCF 45 / LCF 55	EZ PLUS	17156
<i>FXF1004</i>	<i>FRR0504A</i>	THRU 1989	BRONCO II / RANGER 4/WD	CLASSIC	18058
FF1504H	FR250SDE	1987 to 1991	F100 / F150 / BRONCO 4/WD	CLASSIC	17096
FF2504	FR250SDE	1987 to 1991	F250 and F350 PICKUP 4/WD	CLASSIC	17092
<i>FFSD</i>	<i>FRSD</i>	1988 to 1991	F450 CAB CHASSIS 2/WD	CLASSIC	17096
FF1504H	FR250SDE	1992 to 1996	F150 PICKUP / BRONCO 4/WD	CLASSIC	17097
FF1504H	<i>FAR001</i>	1992	BRONCO 4/WD	CLASSIC	17097
FF2504A	<i>FR250DE</i>	1992 to 1998	F250 4/WD	CLASSIC	17098
FF3504A	FR350SDE	1992 to 1998	F350 4/WD	CLASSIC	17095
FF3504A	FR350SDE	1992 to 1998	F350 4/WD	CLASSIC	17106
FFSD	<i>FRSD</i>	1992 to 1998	F450 CAB CHASSIS 2/WD	CLASSIC	17105
FF150974A	<i>FR1525HD</i>	1997 to 1999	F150 PICKUP 4/WD	CLASSIC	17108
FF150974A	<i>FR1525HD</i>	1997 to 1999	F250 LD 4/WD) 7,700 lb. G.V.W.R	CLASSIC	17108
FF150974A	<i>FR1525HD</i>	2000 to 2003	F150 PICKUP 4/WD 7,700 lb. G.V.W.R	CLASSIC	17108
<i>FF350SD4</i>	<i>FRFXC4</i>	1999 to 2005	EXCURSION 4/WD	CLASSIC	17112
FF350SD2	FR250SDE	1999 to 2004	F250 and F350 PICKUP 2/WD	CLASSIC	17115
FF350SD4B	FR250SDE	1999 to 2004	F250 4/WD WITH SNOWPLOW PREP. 5200LB. F.G.A.W.R	CLASSIC	17112
<i>FF350SD4</i>	<i>FR150SDE</i>	1999 to 2004	F250 4/WD WITHOUT SNOWPLOW PREP. PACKAGE	CLASSIC	17112
FXF1004	<i>FRR0504A</i>	1998 TO 2007	RANGER	DRIVE PRO	18505
FF350SD4B	<i>FR250SDF</i>	1999 to 2004	F250 4/WD - WITH SNOWPLOW PREP. 6000LB. F.G.A.W.R	CLASSIC	17113
<i>FF350SDC</i>	<i>FR250SDF</i>	1999 to 2004	F250 4/WD - WITHOUT SNOWPLOW PREP. PACKAGE	CLASSIC	17113
<i>FFSD4</i>	<i>FRSD</i>	1999 to 2004	F450 and F550 SUPERDUTY 2 OR 4/WD	CLASSIC	17113
<i>FF550SDE</i>	<i>FRSD</i>	2005 to 2007	F450 and F550 2 OR 4/WD	CLASSIC	17113
FF1504H	FR250SDE	1984 to 1991	F150 PICKUP 4/WD	CUSTOM	17081

ITEMS IN BOLD ARE STOCKED BY MEYER PRODUCTS. NON BOLD PART NUMBERS LISTED IN ITALICS ARE SPECIAL ORDER ONLY. PLEASE USE TIMBREN PART NUMBER WHEN ORDERING.

***= PROFESSIONAL INSTALLATION REQUIRED

WHELEN® SAFETY LIGHTS

Whelen Safety Lights

Helps increase the visibility and safety of your vehicle during nighttime plowing operation. Can be permanently or temporarily mounted to the roof of any vehicle. Various sizes and configurations available.

Guardian™ Rotating Strobe 'G2MA'

- SAE Class 1 Intensity
- 92,000 Beam Candlepower
- 55 Watt H-1 Halogen Bulbs (Widely Available for Replacement)
- 175 FPM
- 4 50# Pull Magnets
- 8' Straight Cord with Cigar Plug
- 8 Amp Draw (12 VDC Only)
- Quiet and Reliable Double Ball Bearing Motor Assembly with 3 Year Factory Warranty

Guardian™ Strobe Lightbar 'G7MA'

- SAE Class 1 Intensity
- Built-in Power Supply: 33 Watt Output, 12 Joules
- 120 FPM (480 Effective FPM)
- 10 Selectable Flash Patterns
- 4 50# Pull Magnets
- 8' Straight Cord with Cigar Plug
- 3 Amp Draw (12/24 VDC)
- Hi-Low Intensity Control
- 2 Year Warranty

1500 Series Strobe '1502MA'

- Secondary Warning Light
- 1.35 Joules
- 90 Single FPM
- 10-80 VDC
- Twist-off Dome
- 80# Pull Magnet
- 2 Year Warranty (Electronics)

2000 Series Strobe '2022LPAM'

- SAE Class 1 Intensity
- 22 Watt / 19 Joule Output
- 72 Quint FPM
- 8' Straight Cord with Cigar Plug
- 2.5 Amp Draw (12/24 VDC)
- Hi-Low Intensity Control
- 3 Year Warranty (Electronics)

Hide-Away Kit 'S450CCCC'

- 4 Hide-a-way Strobe Tubes, Plug-in Style (12 Month Warranty)
- 4 15' Shielded Strobe Cables with AMP Connectors
- 4-Outlet, 50-Watt Output Power Supply
- 10 Selectable Flash Patterns
- Simultaneous or Alternating Flashing
- Hi-Low Intensity Control
- 5.2 Amp Draw (12/24 VDC)
- Fully Encapsulated Electronics (3 Year Warranty)



Back-up Alarm 'WBUA97'

- 97 dB Alarm
- Meets OSHA and All State Regulations (SAE J994 Class C)
- Fully Encapsulated Electronics
- Steam Cleanable; Pressure Washable
- 0.2 Amp Draw, 12/24 VDC
- 2 Year Warranty

Responder Low Profile Series with CON3 'R1LPVA'

- Class 1, SAE J845 Certified
- 100,000 Hour Rated Life
- 6 Super-LED Modules: Conical (CON3) Modules
- Built-In Electronic Flasher with 30 Scan-Lock Flash Patterns plus 4 Simulated Rotating Patterns (Permanent Mount Versions Only)
- ActionScan Default Flash Pattern
- Magnetic/Suction Mount
- Polycarbonate Dome with Smooth Exterior will not Gather Dirt and Dust
- 12 VDC
- R1LP Models: 3.0 Amp Draw (Peak), 1.2 Amp Draw (Avg)

LED Beacon – Magnetic Mount 'L21HAM'

- SAE J845 Class 1 Certified
- Rivals Strobe in Intensity, with Lower Amp Draw
- Combination Pipe, Permanent and J-Hook Polycarbonate Mounting Base
- Virtually No EMI Radiation
- 24 Built-In Scan-Lock™ Flash Patterns Plus SignalAlert™
- Magnetic Mount with 10-Ft. Straight Cord, LED Indicator Switch and 12V Power Plug

SuperLED Beacon – Magnetic Mount 'L22HAM'

- SAE Class 2 Certified
- LEDs Rated for 100,000 Hours of Operation
- LED Technology Rivals Strobe in Impact but with Lower Amp Draw
- Produces 75 SignalAlert™ Flashes Per Minute; 15 Scan-Lock Flash Patterns
- Heavy-Duty Polycarbonate Base and Dome

Whelen Safety Lights

Meyer Part Number	Description
G2MA	WH Guardian Rotating Strobe, 55 Watt
G7MA	WH Guardian Strobe Lightbar, 40 Watt, 16 Joules
1502MA	WH 1500 Series Strobe, 2 Watt, 1.35 Joules
2022LPAM	WH 2000 Series Strobe, 22 Watt, 19 Joules
S450CCCC	WH Hide away Kit, 4 Clear, 50 Watt
S450AAAA	WH Hide away Kit, 4 Amber, 50 Watt
WBUA97	WH 97db Backup Alarm, 12-24 VDC
R1LPVA	Responder Low Profile Series with CON3
L21HAM	LED Beacon – Magnetic Mount
L22HAM	SuperLED Beacon – Magnetic Mount

SHURTRAX BALLAST SOLUTION

ShurTrax Ballast Solution

To improve the ballast of your plow and truck, ShurTrax is the easy, safe way to add up to 400lbs traction weight to trucks and SUV's. Just fill the super-tough, woven mesh reinforced ballast bag with water from your garden hose, and you're ready to go. It's designed to freeze and has been tested to -40 degree F/C. Unit is designed to lie flat in the bed and is tough enough to support 500lbs. of cargo.

Part #LW-0048 (Compact/SUV truck)

Part #LW-0056 (Full size pick-up truck)

Part #LW-0036 (Automobile/CUV)



Plow Cart Accessories

Item	Vehicle Size	Dimensions	Weight Full	Outer Material	Inner Material	Vehicle Examples
ST-LW0056	Full Size Pickup or SUV	60x56x3	400 lbs.	25 mil vinyl	25 mil vinyl	Cadillac Escalade EXT, Chevrolet Silverado, Chevrolet Avalanche, Ford F-150 pickup, Ford F-250 pickup, Ford F-350 pickup, Dodge Ram pickup, GMC Sierra pickup, Lincoln Mark LT, Nissan Titan, Toyota Tundra
ST-LW0048	Compact Pickup or medium duty SUV	56x48x3	300 lbs.	25 mil vinyl	25 mil vinyl	Chevrolet Colorado, Chevrolet S-10, Dodge Dakota, Ford Ranger, GMC Canyon, GMC Sonoma, Isuzu pickup, Mazda pickup, Nissan Frontier, Toyota Tacoma
ST-LW0036	Auto/ small SUV / CUV	36x24x3	100 lbs.	25 mil vinyl	25 mil vinyl	

PLOW CARTS

Plow Carts

Moving and/or maneuvering a fully assembled plow can be a difficult task! However, with the Meyer EZ-Cart moving a plow is EASY. Plow carts are highly mobile custom cradles that allow anyone to move an unattached plow quickly and easily. Now, move your plow around as easily as your gas grill with the Meyer Plow cart. Choose the correct cart for your specific plow. Plow carts come as one (1) unit and come with all hardware and instructions for an easily installation.

Plow Cart Accessories

Item	Description
QMB-DP	Fits Drive Pro 6' 0" or 6' 8"
QMB-JB	Fits Plus or MDII (ST, C, LP, DE or SV)
QMB-ST	Fits Custom or Classic (ST, C, LP, D, HU)
QME-SB	Lift Frame Carrier used with QMB-ST
QMS-ST	Plow cart fits EZ-Mount and Classic, Western and Fisher
QMB-BT	Plow cart fits Boss Trip Edge
QMB-CH	Plow cart fits Fisher Mm2/Hin/Curt
QMB-SW	Plow cart fits Sno-Way 3-Pt Hitch
QMB-UB	Plow cart fits Sno-Way 2 Pt. Hitch
QMB-UV	Plow cart fits Fisher Mm2-V
QMU-FV	Plow cart fits Boss and Hiniker V-Plow
QMU-UN	Plow cart fits Suburbanite Unimount, Western and Fisher
QMW-PP	Plow cart fits Western Pro Plus
QMW-UM	Plow cart fits Western Ultra Mount
QMW-UV	Plow cart fits Western Ultramount - V



ALLIED PRODUCTS

OEM VEHICLE MANUFACTURER RECOMMENDATIONS – GM/GMC

Prior to installing a front mounted snowplow, the following process should be followed, and necessary information obtained:

Determine front and rear axle curb weight. Determine chassis front and rear axle weight ratings (GAWRF/GAWRR) see your bodybuilder book/certification label/incomplete vehicle document or dealer. Calculate a weight distribution for the front and rear axles with the snow plow, occupants in the cab, cargo and after market accessories. The loaded vehicle with driver, passenger, aftermarket accessories, snowplow, spreader and cargo, must not exceed gross vehicle rating (GVWR) or front and rear gross axle weight rating. As a general guide for equipped vehicles, with a 650 lb. plow mounted, the cargo, occupant and aftermarket accessories weight must not exceed 300 lbs. The use of ballast weight may be required, to prevent exceeding the gross axle weight rating of the front axle (GAWRF). Ballast should be securely attached in the pickup box behind the rear axle of the vehicle. An empty vehicle with snowplow and accessories mounted must not have more than 62% of the total weight on its front axle, so as to meet braking requirements and FMVSS 105 regulations.

General Motors Corp.

General Motors recommends snowplow usage for only those trucks that have the option "VYU" Snow Plow Preparation Package.

YEAR	MODEL	G.V.W.	OPTION CODE	FRONT G.V.W.R.
1988 to 1997	REGULAR CAB ONLY			
	K 1500	FRONT G.A.W.R.		3600 lb.
	K 2500			3750 lb.
	K 3500			3750 lb.
1997	EXTENDED CAB			
	K2500/3500			4250 lb.
1998 to 2006	REGULAR CAB ONLY			
	K 1500	6100 lb.	C5M	3925 lb.
	K1500	6400 lb.	C7H	3925 lb.
	REGULAR/EXTENDED CAB			
	C 2500	7200 lb.	C5Z	4100 lb.
	C 2500	8600 lb.	C6P	4100 lb.
	K 2500	8600 lb.	C6P	4500 lb.
2001 to 2006	ALL MODELS	9200 lb.	C6W	4800 lb.
	C/K 3500	8600 lb.	C6P	4500 lb.
2001 to 2007	All Models	11,400 lb.	C7W	4800 lb.
	CAB CHASSIS REGULAR CAB ONLY			
	C 3500	8600 lb.	C6P	4100 lb.
	K 3500	8600 lb.	C6P	4500 lb.
	K 3500	12,000 lb.	C7L	4800 lb.
2007 and NOV. 2007	K1500	6100 lb.	C5M	3925 lb.
	K1500 (Nov. 2007)	N/A	N/A	N/A
SPORT UTILITY VEHICLES				
2000 to 2007	C2500	8600 lb.	C6P	4100 lb.
	K2500			4500 lb.
	K3500			4500 lb.
2008 to 2009	C2500	9200 lb.	C6P	4100 lb.
	K2500			4800 lb.
	K3500			4800 lb.

General Motors recommends that when a snow plow is mounted that only one passenger should accompany the driver. More than one passenger may exceed front gross axle weight ratings.

NOTE:

- 2007 K1500 PICK UP 4/WD WILL HAVE A FRAME CHANGE SOMETIME IN NOVEMBER 2007.
- ALL 2007 UTILITY VEHICLES BEGIN 2007 WITH NEW FRAME.

OEM VEHICLE MANUFACTURER RECOMMENDATIONS – FORD

Ford Motor Company

Snow Plows on NOT recommended vehicles. Applying a snowplow to a model shown as "N/R" (not recommended), or to 4X2 models, does not in of itself void the Normal Ford New Vehicle Warranty. However, Warranty may be denied if the addition of occupants in any available seat belt position would result in vehicle overloading. For all models, whether recommended or not, Warranty denial may also occur if damage to any Ford part of vehicle system results from the installation of the after market equipment.

YEAR	MODEL	G.V.W.	OPTION CODE	FRONT G.V.W.R.
THRU 1996	F150 REGULAR CAB 4WD			
THRU 1992	BRONCO			3800 lb.
THRU 1998	F250, F350 4WD			4600 lb.
	F350 CAB CHASSIS 2/WD or 4/WD • GAS or DIESEL			5000 lb.
THRU 1998	VEHICLES NOT RECOMMENDED			
	SUPER AND CREW CAB, SHORT WHEEL BASE MODELS.			
	PICK UP with 7.3L V-8 DIESEL (99M) ENGINE			
1997 thru 1999	F150 LD REGULAR CAB PERSONAL USE ONLY.		53C	3900 lb.
	F250 LD REGULAR CAB			4150 lb.
1997 - 1998	F250 HD			4600 lb.
	F350			4800 lb.
	F350 CAB CHASSIS 2/WD or 4/WD • GAS or DIESEL			5000 lb.
2000 - 2003	F150 Regular and Supercab 138.8" WB	7700 lb.	627	4150 lb.
2000 - 2003	VEHICLES NOT RECOMMENDED			
	SUPER AND CREW CAB, SHORT WHEEL BASE MODELS.			
	PICK UP with 7.3L V-8 DIESEL (99M) ENGINE			
2004-2009	F150 8200 G.V.W.R.			
	REGULAR CAB - 144.7" WB • 8' Box -		63A	4300 lb.
	SUPER CAB - 163.3" WB • 8' Box -			4300 lb.
2004-2006	VEHICLES NOT RECOMMENDED			
	SUPER CREW CAB			
1999 - 2006	F SERIES - SUPER DUTY - SET TIRE PRESSURE TO - 75 P.S.I.		Option (86M)	
	F250 • F350		Code (V)	5200 lb.
	F250 • F350 • F450 • F550		Code (X)	6000 lb.
	Spring code information located on the driver's-side door jam.			
1999-2004	SUPER DUTY PICK UP / CAB CHASSIS RECOMMENDATIONS			
	REGULAR CAB • ALL GAS and 7.3L V8 DIESEL		Option (86M)	6000 lb.
	SUPER CAB and CREW CAB • 5.4L V8 GAS • 6.8 V10 GAS			
2005-2007	F250 THRU F 550 4/WD ALL		Option (86M)	6000 lb.
2008-2009	F250 THRU F 550 4/WD		Option (86M)	6000 lb.

OEM VEHICLE MANUFACTURER RECOMMENDATIONS – CHRYSLER

Chrysler Corporation

Chrysler Corporation recommends snowplow usage for only those trucks that have the "AHH" / "AHD" Snow Plow Preparation Package.

YEAR	MODEL	WHEEL BASE	PREP PACKAGE	ENGINE CODE	FRONT G.V.W.R.	
1972 to 1993	DAKOTA	REGULAR CAB	AHH	3.9L (6 CYL.)	5,770 LBS	
		CLUB CAB			5,830 LBS	
	W 150,	REG. CAB	106"/115"/131"	AHH	ELF, EML	4,000 LBS
	W 250 LD	REG/CAB	115"/131"/149"	AHH	EFL, EML	4,000 LBS
		CLUB CAB				4,500 LBS
	W 250 HD	REG/CLUB CAB	115"/131"/149"	AHD	EML, EML, ETB	4,500 LBS
	W 350	REG CAB	131"/135"	AHD	EML, EML, ETB	4,500 LBS
CAB CHASSIS		ETB				5,000 LBS

VEHICLES EQUIPPED WITH DIESEL ENGINES PRIOR TO 1992 MODEL YEAR ARE NOT RECOMMENDED FOR SNOW PLOW APPLICATION.

YEAR	MODEL	WHEEL BASE	PREP PACKAGE	ENGINE CODE	FRONT G.V.W.R.
1994 to 1996	DAKOTA	REG/CLUB	AHH	3.9L (GAS) 6 CYL.	3,850 LBS
1994 to 1999	W 1500	REG. CAB	AHH	ELF, EML	3,850 LBS
	W 2500/3500	REG. CAB	AHD	ELF, EML, EMM, EWA, ETC	4,850 LBS
		CLUB CAB	AHD	EML (ONLY)	4,850 LBS
		QUAD	AHD	EML, (EMM -154.7" ONLY)	4,850 LBS
	W 2500	CAB CHASSIS	AHD	EML, EWA	4,850 LBS
	W 3500	REG. CAB	AHD	EML, EMM, EWA, ETC, ETB	4,850 LBS
CAB CHASSIS		AHD	EML, EMM, EWA, ETC, ETB	4,850 LBS	

1972 TO 1999 APPROVED ENGINE CODES

ELF: 5.2L V8 GAS	EML: 5.9L GAS L/D	ETB/ETC: 5.9L I-6 24 VALVE DIESEL
EWA: 8.0L V10 GAS	EMM: 5.9L V8 GAS H/D	ETH: 5.9L I-6 24 VALVE DIESEL HIGH OUTPUT

VEHICLES NOT RECOMMENDED

YEAR	MODEL	ENGINE CODE
1994-1996	Dakota Club	5.2L (8Cyl.)
1997-2001	Dakota	All Models
1997-1998	W1500	All Models
1995-1996	W2500	Club Cab
1997-1999	W2500	Quad/Club Cab
	W3500	
1998-1999	W3500	Quad/Club Cab

OEM VEHICLE MANUFACTURER RECOMMENDATIONS – CHRYSLER (CONT.)

YEAR	MODEL	PU/ BOX	G.V.W.	WHEEL BASE	PREP PACKAGE	ENGINE CODE	FRONT G.V.W.R.	
2004 to 2009	W 2500	REG. CAB	8.0'	8,650	140.5"	AHD	• ETH, EZA	5,200 LBS
	W 3500		8.0'	11,500	140.5"	AHD	• ETH, ***** EZA	5,200 LBS
	W 2500	QUAD CAB	6.5'	8,000	140.5"	AHD	•• ETH, EZA	5,000 LBS
	W 3500		8.0'	8,800	160.5"		EML, EWA, •• ETC	5,200 LBS
	W 3500	QUAD CAB	6.5'	9,900	140.5"	AHD	••• ETH	5,200 LBS
	W 2500	QUAD CAB	8.0'	9,900	160.5"	AHD	•••• EZA, ETH	5,200 LBS

• NEW FOR 2000 ••• THREE OCCUPANTS •• TWO OCCUPANTS •••• NEW FOR 2001
 ***** NEW FOR 2002 * TOTAL WEIGHT OF PLOW AND HARDWARE NOT TO EXCEED 525 LBS.

ENGINE CODES

EZA: 5.7L V8 GAS	ETH: 5.9L HO DIESEL
------------------	---------------------

MINIMUM BALLAST REQUIREMENTS (8.0" from the rear tailgate)

1994-2002	1500	Reg. Cab	6.5 ft.	EFL, EML	250 lb.
1994-2002	2500	Reg. Cab	8.0 ft.	ETC, ETH	200 lb.
1994-2002	3500	Reg. Cab	8.0 ft.	ETC	400 lb.
1994-2002	2500	Quad Cab	8.0 ft.	EWA	300 lb.
1994-2002	2500	Quad Cab	8.0 ft.	ETC	600 lb.
2001- 2002	2500	Quad Cab	8.0 ft.	ETC	300 lb.
1994-2002	2500	Quad Cab	6.5 ft.	ETH	200 lb.

2003/2006 APPROVED ENGINE CODES

EZA: 5.7L V8 GAS	ETC: 5.9L DIESEL
EWA: 8.0L V10 GAS	ETH: 5.9L HO DIESEL

JEEP (CHRYSLER)

SHOCK KIT REQUIRED FOR SNOWPLOW APPLICATION:

1997-2003 WRANGLER (AIR SHOCK KIT 82202562) **OBSOLETE**
 1997-2002 CHEROKEE (AIR SHOCK KIT 82202562) **OBSOLETE**

It is the installer's responsibility to be sure the vehicle has the manufacturer's maximum capacity front suspension option and the manufacturer recommends the vehicle for plow usage.

VEHICLES NOT RECOMMENDED

- 1982 - 1996 (XJ) **COMMANCHE**
- 1987 - 1999 **GRAND WAGONEER**
- 1991 - 1994 (YJ) **RENEGADE**
- 1993 - 2006 **GRAND CHEROKEE**
- 02/06 **JEEP LIBERTY**

HEADLIGHT ADAPTER CROSS-REFERENCE

ADAPTER KIT NO.	HEADLAMP BULB TYPE		SYSTEM TYPE	MANUFACTURER/VEHICLE MODEL YEAR	HEADLIGHT CONFIGURATION
07101	2A1 Low 4652 H4656	1A1 High 4651 H4651	4 Lamp Rectangular	Chevy/GMC 1988 thru 2000	
07102	HB5 H9007		Replacement Bulb	Ford F Series 1999 thru 2004 Dodge W Series 2003 thru 2004	
07103	LF Low H4703	UF High H4701	4 Lamp Rectangular		
07104	HB4 Low H9006	HB3 High H9005	Replacement Bulb	Chevy/GMC 1988 thru 2000	
07105	2E1 H4666 H6545 HP6545		2 Lamp Rectangular		
07106	HB1 H9004		Replacement Bulb	Dodge W Series 1999 thru 2002	
07108	HB4 Low H9006	HB3 High H9005	Replacement Bulb	Chevy/GMC 1999 thru 2002 vehicles Avalanche 2002 thru 2003 DRL separate from truck headlamps	
07180	2D1 6014 H6014 6015 H6017 H6024	2B1 6052 H6052 H6054 HP6054 H5054 H6054LL	2 Lamp Round	Chevy/GMC 1988 thru 2000 Ford F Series Excursion 2005 and later	
	HB2 H9003 H9003LL	2 Lamp Rectangular			
07190	HB5 H9007	HB1 H9004	Replacement Bulb	Dodge Ram Sport 1999 US models only Quad headlamps	
07205	HB4 Low H9006	HB3 High H9005	Replacement Bulb	Nissan Titan 2005 and later	
07213	HB4 Low H9006	HB3 High H9005	Replacement Bulb	Chevy Blazer, S10 and Sonoma 1998 and up	
07221	HB5 H9007	HB1 H9004	Replacement Bulb	Dodge Ram Sport 1999 and up US and Canadian models Quad headlamps	
07333	H11 Low	HB3 High H9005	Replacement Bulb	Chevy X88/GMC Z88 K 1500/2500 Series Tahoe 1/2 ton Suburban 3/4 ton 2007 and up DRL on headlamps	
07334	H13 H9008		Replacement Bulb	GMC Z88 Utility Yukon 1/2 ton Yukon XL 3/4 ton 2007 and up DRL on headlamps	
07343	H13 H9008		Replacement Bulb	GMC Z88 Utility 2007 and later	
07344	H13 H9008		Replacement Bulb	Chevy X88 Utility 2007 and later	
07353	H11 Low	HB3 High H9005	Replacement Bulb	Toyota Tundra 2007 and later	

THE MEYER® BRAND FEATURES

**Highway plow inspired design...
simplified to be more reliable.**



Meyer push frames are designed to provide maximum strength and support for the moldboard across the entire back of the plow utilizing a heavy-duty tubular frame and reinforcement bar. Lot Pro push frames attach at three points to help reduce load pressure when plowing. In addition, all A-frames are constructed from tubular steel to increase strength and rigidity.

Heavy-duty 1" king bolt is greaseable and reinforced for maximum durability while enhancing backdragging performance. Back stops are incorporated into the design for maximum strength and longevity.

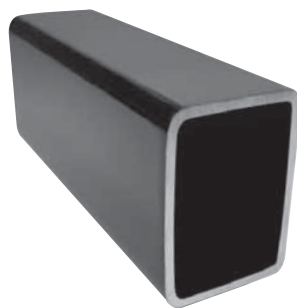

Tubular Steel Construction

All push- and A-frames feature heavy-walled tubular-steel. Look for this feature on all Drive Pro,[™] Lot Pro,[™] Road Pro[™] and Super-V[™] snowplows.



Operating systems with all-new custom molded covers.

Meyer's operating systems are designed to maximize performance and ensure safe and efficient operation of the plow. All units feature high flow valves with triple sealed coils **1** to give you the performance and reliability commercial plowing demands. Inter-locking connectors **2** on all electrical harnesses simplifies maintenance, while ensuring reliability and **3** stainless steel coils are fully sealed to eliminate water intrusion and corrosion. All Meyer hydraulic units feature a custom molded cover to protect wiring and connectors from the elements. In addition, the cover does not need to be removed for variable drop speed adjustment.

THE MEYER® BRAND FEATURES

Taller, more aggressive moldboards.

All moldboards are designed with aggressive attack angles and increased height. This means you can move more snow faster and throw it farther than any other plow on the market. Full-trip moldboards are available in steel or polyethylene. Trip edge moldboards are available in steel only to meet your application requirements.

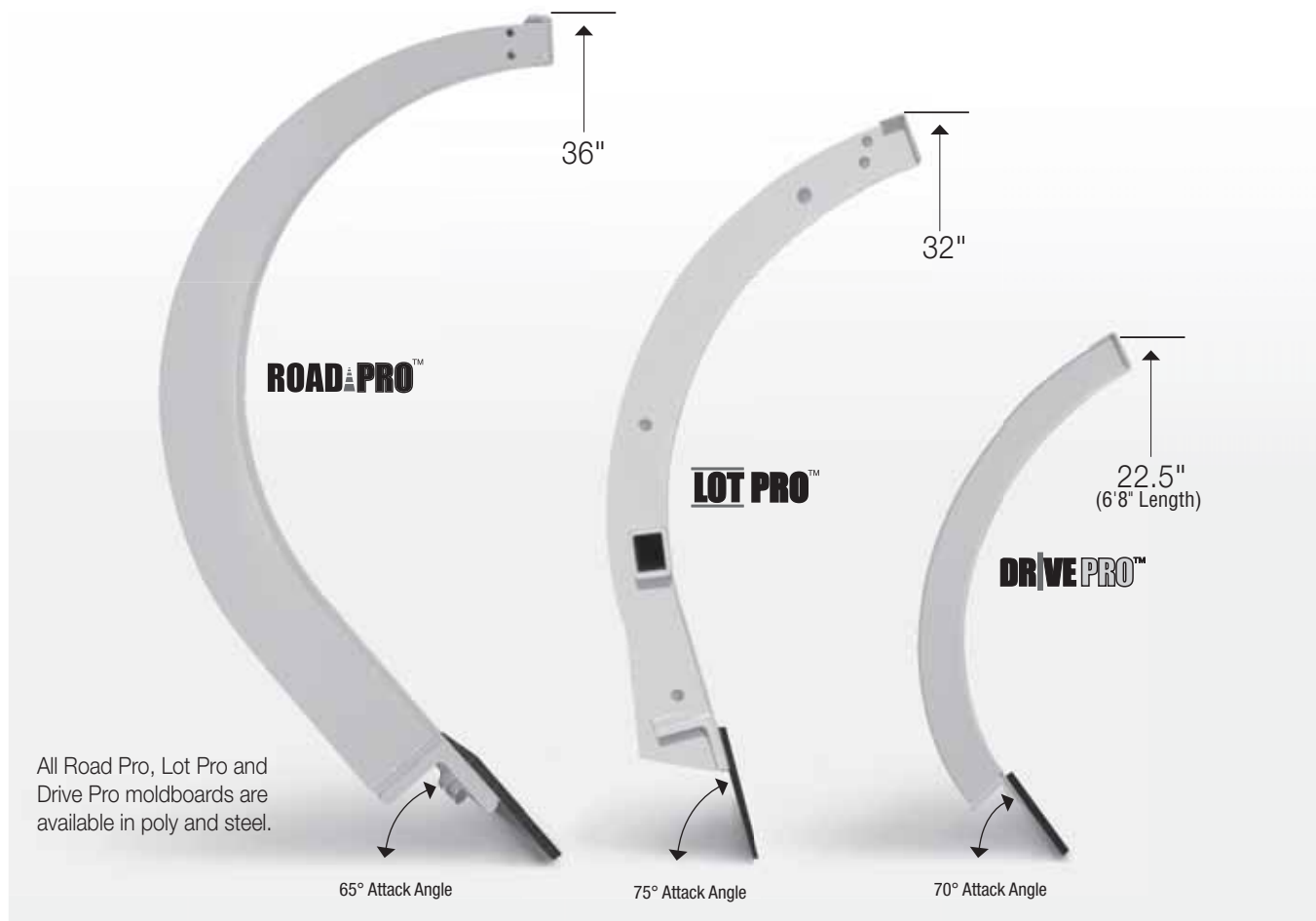

Better Backdragging

Each Meyer moldboard is designed to provide optimal clearing during backdragging. Maximum weight distribution on the cutting edge and aggressive attack angle help pull more snow and break-up ice, to keep you moving.



Paint that Improves Performance

All steel moldboards feature our DURA-SLICK™ Paint System with Teflon® baked onto the steel. It improves durability and provides better snow rolling action.



Providing the Edge You Need

Three cutting edges (steel, rubber or polyurethane) are designed to provide the flexibility you need to meet the varying conditions found in commercial plowing.

THE MEYER® BRAND FEATURES

Easy on. Easy off. In seconds.

Every plow system we manufacture is designed to keep you moving so you can get to the next job faster. Our industry leading features keep you behind the wheel plowing snow, making daily plowing activities easier and faster.



Fast, interchangeable mounting system.

EZ-Mount® Plus™ Mounting System

The EZ-Mount® Plus is perfect for users that want the convenience of a modular system that allows the lift frame, hydraulic power system and moldboard to be removed as a single unit. When removed, it features an under carriage mounting system that virtually hides the mount, leaving a clean, neat appearance. Mounting is quick and easy. Simply pull up, connect the power supply, engage two pins, and you're on your way.

Fleet-friendly Management

When you're running more than one truck, interchangeable moldboards and controllers make it easy to substitute one plow for another.

THE MEYER® BRAND FEATURES



Meyer Lot Pro shown with optional fixed wings, deflector and Nite Saber® II lights.

Patented Single Plug Connector

While competitors have 2-3 plugs, Meyer's patented marine style locking plug requires only one connection for fast mount/dismount of the plow. It features silver coated connections for maximum corrosion resistance. All outside connectors are triple sealed against harsh environmental conditions. Spring loaded cap automatically closes and seals truck side harness when plug is removed.

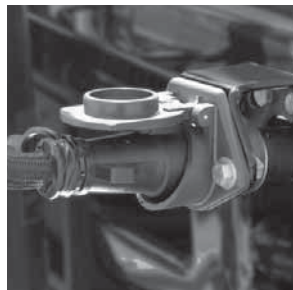

Adjustable Jack

Infinitely adjustable jack allows for easy on/off on wet ground, uneven terrain or following a long summer storage period. Also, the adjustable jack helps mount plows to different vehicles with varying heights. Stores directly on the lift frame for quick, easy access.

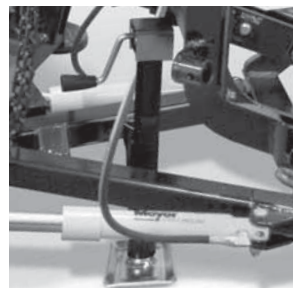

Get the Controller That's Right for You.

Meyer offers touchpad, pistol grip or joystick controllers to meet your exacting requirements. All controllers are illuminated for nighttime operation and can be handheld or leg strapped depending on your requirements. Self diagnostics are standard to help during maintenance operations.



Pistol Grip Controller

(Standard) Meyer pistol grip controllers, featuring one button functionality and self diagnostics, ensure worry-free operation of all plowing functions. Ergonomic design is comfortable and easy to use.



Joystick Controller with ALM/ARM Operates with straight blades and Super-V plows. Controller is illuminated and equipped with self diagnostics. The ARM mode automatically raises the plow when the operator shifts the vehicle in reverse. The ALM mode automatically lowers the plow when the operator shifts to reverse.



Pistol Grip DLX Controller with ALM/ARM

Operates Super-V and Meyer straight blade plows. It features Automatic Raise Mode (ARM) and Automatic Lower Mode (ALM) and one button functionality for scoop, V and straight blade modes. The ARM mode automatically raises the plow when the operator shifts the vehicle to reverse. The ALM mode automatically lowers the plow when the operator shifts the vehicle into reverse. In addition, the DLX controller features a back-lit keyboard, self diagnostics and is compatible with ALL Meyer plow systems.



Touchpad Controller Perform all plow movements for straight blade plows with the touchpad control. Unit features self diagnostics and convenient indicator lights.

All Meyer Controllers are illuminated for convenient nighttime operation.



Best built, best backed plows in the industry.

Only Meyer plows are built with Reliable Over-time Construction (ROC)... the detailed things we do that make our plows more rugged and reliable. ROC is the result of manufacturing improvements and state-of-the-art technology combined with stringent quality control procedures.

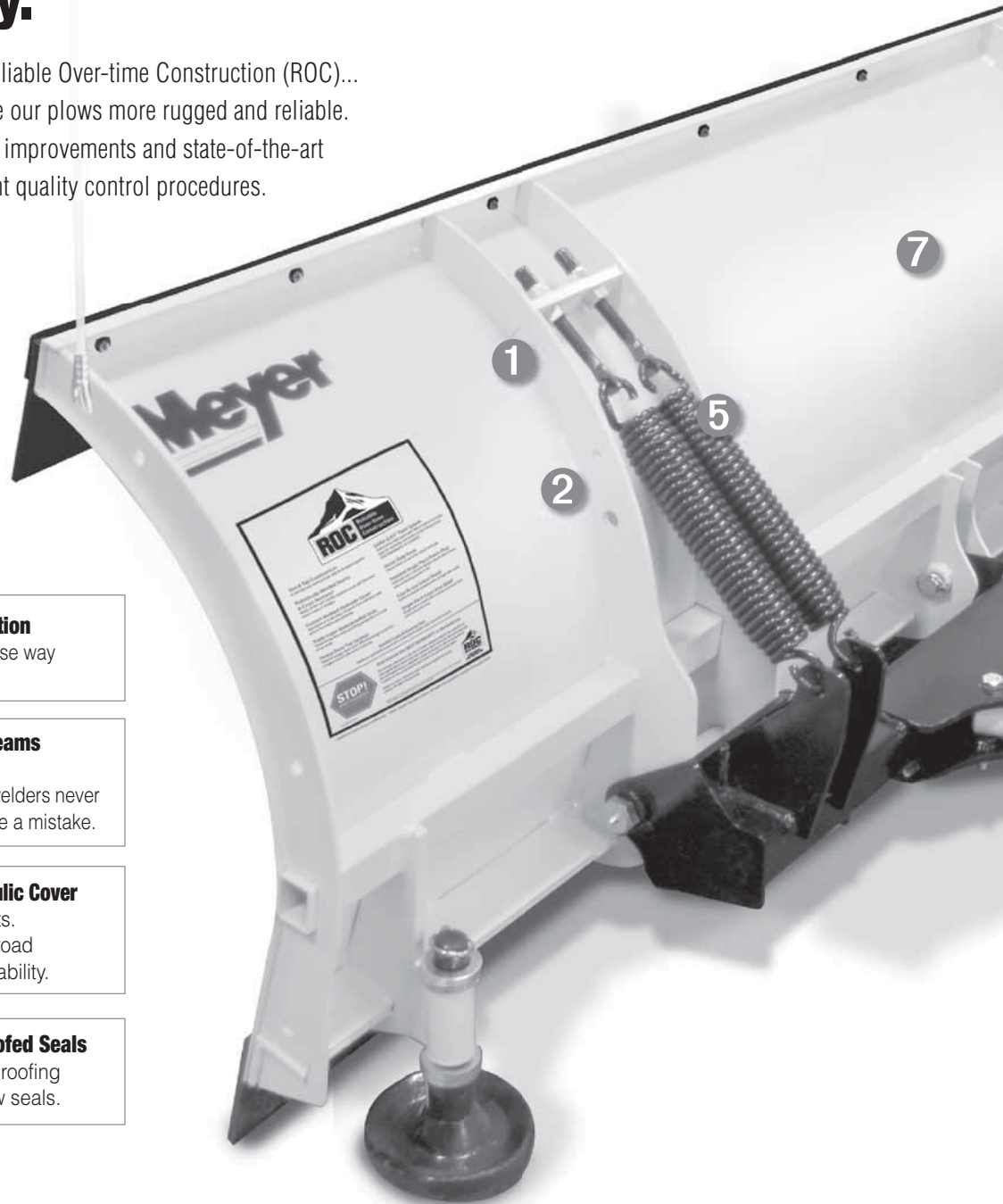

1

Slot and Tab Construction

A strong and more precise way to fit steel together.

2

Robotically-Welded Seams and Cross-Sections

State-of-the-art robotic welders never get tired and never make a mistake.

3

Custom Molded Hydraulic Cover

Standard on E-58H units. Protects from salt and road grime for improved reliability.

4

Triple-Layer Waterproofed Seals

Three times the waterproofing protection of most plow seals.



8 Heavy-Duty Rams
Thicker walls on rams for added strength.

9 Patented Single-Piece Power Plug
Patented one-connector design means fewer wires and connecting points to fail.

10 Easy Access Grease Points
Easily accessible grease points at high-wear areas.

11 Single-Piece Cross-Over Relief
Single-piece construction means less down time, more plow time.

5 Heavy-Duty Trip Springs
Heavier gauge and more efficient design yield the longest service life in the industry.

6 Sealed Coils and Connectors
Reduces debilitating corrosion of electrical system and mechanical parts.

7 DURA-SLICK™ Paint System
Automotive-style paint with Teflon® baked on to the steel for durability and better snow-rolling action. (Poly Moldboards not included.)



The industry's best warranty protection.

3 YEARS
Standard*

5 YEARS
On all structural steel*

* Register new plows and Blaster spreader systems online at www.meyerproducts.com to activate years 3 through 5.

LIMITED WARRANTY – MEYER® SNOW PLOWS

EFFECTIVE AUGUST 1, 2006

What is Covered:

Meyer Products, LLC, warrants to the original purchaser of Meyer® branded products that they will be free from defects in materials or workmanship, with the exceptions stated below. No person is authorized to change this warranty or to create any additional warranty on Meyer® products.

How Long Coverage Lasts:

This warranty runs for a period of two years from the date of purchase on any purchase of a complete Snow Plow Package. If the Package is registered online at www.meyerproducts.com within sixty (60) days of purchase, your warranty for the Package will be extended for a period of one year and you will also receive a warranty for a period of five years from the date of purchase on Structural Steel. In addition to the warranties covering a complete Snow Plow Package and Structural Steel, you will receive a warranty for a period of one year from the date of purchase on individual parts, components, or accessories. All foregoing warranties apply only to an original purchaser of the product if the product is installed by an authorized Distributor/Sub-Distributor and terminate if the product is sold or otherwise transferred. Some states do not allow limitations on how long an implied warranty lasts, so the above limitation may not apply to you.

What is Not Covered:

This warranty does not cover:

- Problems caused by failure to follow the product instructions, failure to maintain the product as described in the Operator's Manual, or failure to maintain proper levels of lubricants;
- Problems caused by contamination or restriction of lubricant systems, or damage resulting from rust, corrosion, freezing or overheating;
- Paint, or expendable snow plow parts such as pins, runners, cutting edges, chrome plating, springs and markers;
- Damage to any vehicle to which the products are mounted, or the suitability of any product for vehicles which are not fitted with the appropriate heavy-duty snow plow service preparation parts;
- Damage caused by usage that is not in accordance with product instructions (use of the snow plow for any purpose other than plowing snow is considered misuse and abuse);
- Any snow plow, or any part, component, or assembly thereof, which has been modified or altered;
- Problems caused by using accessories, parts, or components not supplied by Meyer Products;
- Cost of tax, freight, transportation or storage charges, environmental charges, solvents, sealants, lubricants or any other normal shop supplies.
- Problems caused by collision, fire, theft, vandalism, riot, explosion, lightning, earthquake, windstorm, hail, water, flood, or any other Acts of God;
- Liability for damage to property, or injury to, or death of any person arising out of the operation, maintenance or use of the covered product;
- Products with missing or altered serial numbers;

The original purchaser's sole and exclusive remedy against Meyer Products and its Distributors and Sub-Distributors, and Meyer Products' sole obligation for any and all claims, whether for breach of contract, warranty, tort (including negligence) or otherwise shall be limited to providing, through its authorized Distributor/Sub-Distributor network, all labor and/or parts necessary to correct such defects free of charge. Any cost incurred in returning the product to an authorized Meyer® Distributor/Sub-Distributor is the responsibility of the original purchaser. ALL EXPRESS AND IMPLIED WARRANTIES FOR THE PRODUCT, INCLUDING, WITHOUT LIMITATION, ANY IMPLIED WARRANTIES OF MERCHANTABILITY AND FITNESS FOR A PARTICULAR PURPOSE, ARE LIMITED IN TIME TO THE TERM OF THE LIMITED WARRANTY PERIOD. NO WARRANTIES, WHETHER EXPRESS OR IMPLIED, WILL APPLY AFTER THE LIMITED WARRANTY PERIOD HAS EXPIRED. Meyer Products disclaims liability beyond the remedies provided for in this limited warranty, and disclaims all liability for incidental, consequential, and special damages, including, without limitation, any liability for third-party claims against you for damages, for products not being available for use, or for lost profits. Meyer Products' liability will be no more than the amount you paid for the product that is the subject of a claim; this is the maximum amount for which we are responsible. Some states do not allow the exclusion or limitation of incidental or consequential damages, so the above limitation or exclusion may not apply to you.

What Meyer Products Will Do:

Meyer Products will repair any product that proves to be defective in materials or workmanship. In the event repair is not possible or practical (as determined by Meyer Products in its sole discretion), Meyer Products will either replace the product with a new product of similar model and price, or refund the full purchase price, as determined by Meyer Products.

Customer Responsibilities:

Customer must keep the complete Snow Plow Package serviced/maintained as recommended by Meyer Products. A written record of service must be maintained, along with receipts for maintenance materials purchased. A copy of the maintenance record and pertinent receipts may be requested in the event of a claim.

How To Get Service:

In order to obtain service under this warranty, the original purchaser must:

- Use all reasonable means to protect the complete snow plow package from further damage;
- Return the claimed defective part to the Meyer® Distributor/Sub-Distributor from whom the product was purchased or to any authorized Meyer® Distributor/Sub-Distributor, transportation and freight charges prepaid. Only Meyer® Distributors/Sub-Distributors are authorized to perform the obligations under this warranty. For the address and telephone number of the Meyer® Distributor/Sub-Distributor nearest you, check the telephone directory, go to www.meyerproducts.com, write us at the address below, or call (216) 486-1313 for assistance;
- Provide maintenance record and receipts for required maintenance, if requested;
- Allow inspection of damaged parts and/or complete snow plow package if deemed necessary by Meyer Products.
- It is the responsibility of the original purchaser to establish the warranty period by verifying the original delivery date. A bill of sale, cancelled check or some other appropriate payment record may be kept for that purpose. It is recommended, but not required, that the consumer verify the original delivery date by immediately registering the product for warranty registration at www.meyerproducts.com.

How State Law Applies:

This warranty gives you specific legal rights, and you may also have other rights which vary from state to state.

MEYER PRODUCTS, LLC
18513 Euclid Avenue, Cleveland, Ohio 44112
(216) 486-1313

¹ A complete Snow Plow Package consists of the hydraulic motor, operating controller, lift-frame, mold board and all related items.

² Structural elements consist of the mounting, lift-frame, A-frame, sector, and the mold board.

LIMITED WARRANTY – MEYER® SPREADERS

EFFECTIVE JULY 1, 2007

What is Covered:

Meyer Products LLC warrants to the original purchaser of Meyer® branded spreader products that they will be free from defects in materials or workmanship, with the exceptions stated below. No person is authorized to change this warranty or to create any additional warranty on Meyer® products.

How Long Coverage Lasts:

This warranty runs for a period of one year from the date of purchase, for the original purchaser of the product, except Meyer Blaster series spreaders. Coverage terminates if you sell or otherwise transfer the product. Some states do not allow limitations on how long an implied warranty lasts, so the above limitation may not apply to you.

For Meyer Blaster series spreaders only, this warranty runs for a period of two years from the date of purchase on any purchase of a complete Blaster Spreader Package. If the Package is registered online at www.meyerproducts.com within sixty (60) days of purchase, your warranty for the Package will be extended for a period of one year and you will also receive a warranty for a period of five years from the date of purchase on Structural Steel and Poly Hopper. All foregoing warranties apply only to an original purchaser of the product if the product is installed by an authorized Distributor/Sub-Distributor and terminate if the product is sold or otherwise transferred. Some states do not allow limitations on how long an implied warranty lasts, so the above limitation may not apply to you.

Some states do not allow limitations on how long an implied warranty lasts, so the above limitation may not apply to you.

What is Not Covered:

This warranty does not cover:

- Problems caused by failure to follow the product instructions, or failure to maintain the product as described in the Operator's Manual;
- Damage resulting from rust, corrosion, freezing or overheating;
- Paint, or expendable parts such as pins, spreader fins, and other normal wear items;
- Damage to any vehicle to which the products are mounted, or the suitability of any product for vehicles which are not fitted with the appropriate equipment;
- Damage caused by usage that is not in accordance with product instructions (use of the spreader for any purpose other than spreading approved material is considered misuse and abuse);
- Any spreader, or any part, component, or assembly thereof, which has been modified or altered;
- Problems caused by using accessories, parts, or components not supplied by Meyer Products;
- Cost of tax, freight, transportation or storage charges, environmental charges, solvents, sealants, lubricants or any other normal shop supplies.
- Problems caused by collision, fire, theft, vandalism, riot, explosion, lightning, earthquake, windstorm, hail, water, flood, or any other Acts of God;
- Liability for damage to property, or injury to, or death of any person arising out of the operation, maintenance or use of the covered product;
- Products with missing or altered serial numbers;
- Gasoline engines and hydraulic pumps used as component parts of the spreader (these are warranted by their manufacturer and not by Meyer Products).

The original purchaser's sole and exclusive remedy against Meyer Products, and Meyer Products' sole obligation for any and all claims, whether for breach of contract, warranty, tort (including negligence) or otherwise shall be limited to providing, through its authorized Distributor/Sub-Distributor network, all labor and/or parts necessary to correct such defects free of charge. Any cost incurred in returning the product to an authorized Meyer® Distributor/Sub-Distributor is the responsibility of the original purchaser. ALL EXPRESS AND IMPLIED WARRANTIES FOR THE PRODUCT, INCLUDING, WITHOUT LIMITATION, ANY IMPLIED WARRANTIES OF MERCHANTABILITY AND FITNESS FOR A PARTICULAR PURPOSE, ARE LIMITED IN TIME TO THE TERM OF THE LIMITED WARRANTY PERIOD. NO WARRANTIES, WHETHER EXPRESS OR IMPLIED, WILL APPLY AFTER THE LIMITED WARRANTY PERIOD HAS EXPIRED. Meyer Products disclaims liability beyond the remedies provided for in this limited warranty, and disclaims all liability for incidental, consequential, and special damages, including, without limitation, any liability for third-party claims against you for damages, for products not

being available for use, or for lost profits. Meyer Products' liability will be no more than the amount you paid for the product that is the subject of a claim; this is the maximum amount for which we are responsible. Some states do not allow the exclusion or limitation of incidental or consequential damages, so the above limitation or exclusion may not apply to you.

What Meyer Products Will Do:

Meyer Products will repair any product that proves to be defective in materials or workmanship. In the event repair is not possible or practical (as determined by Meyer Products in its sole discretion), Meyer Products will either replace the product with a new product of similar model and price, or refund the full purchase price, as determined by Meyer Products.

Customer Responsibilities:

Customer must keep the complete spreader system serviced/maintained as recommended by Meyer Products. A written record of service must be maintained, along with receipts for maintenance materials purchased. A copy of the maintenance record and pertinent receipts may be requested in the event of a claim. Electrical or hydraulic components are not to be disassembled without the express written permission of Meyer Products.

How To Get Service:

In order to obtain service under this warranty, the original purchaser must:

- Return the claimed defective part to the Meyer® Distributor/Sub-Distributor from whom the product was purchased or to any authorized Meyer® Distributor/Sub-Distributor, transportation and freight charges prepaid. Only Meyer® Distributors/Sub-Distributors are authorized to perform the obligations under this warranty. For the address and telephone number of the Meyer® Distributor/Sub-Distributor nearest you, check the telephone directory or you may write to Meyer Products at the address below, or call (216) 486-1313 for assistance;
- Defective parts returned to Meyer Products must be accompanied by the following information: spreader model, serial number, date installed and dealer from whom purchased;
- Provide maintenance record and receipts for required maintenance, if requested;
- Allow inspection of damaged parts and/or complete spreader package if deemed necessary by Meyer Products.
- It is the responsibility of the original purchaser to establish the warranty period by verifying the original delivery date. A bill of sale, cancelled check or some other appropriate payment record may be kept for that purpose. It is recommended, but not required, that the consumer verify the original delivery date by immediately registering the product for warranty registration at www.meyerproducts.com.

How State Law Applies:

This warranty gives you specific legal rights, and you may also have other rights which vary from state to state.

MEYER PRODUCTS, LLC
18513 Euclid Avenue, Cleveland, Ohio 44112
(216) 486-1313

THE *HOT* WAY TO CONTACT MEYER

HOTLINE QUICK INSTRUCTIONS

STEP #1: Call Meyer (see Important Information box)

STEP #2: Press 1 for the retailer area

STEP #3: Enter 5 digit PIN number (if prompted)**

STEP #4: Follow the prompts below for fast access to the support service you need

Dial 1 – To reach Technical Support, then choose a category:

1 - Electrical/Wiring Info

2 - Light Systems

3 - Hydraulics

4 - Mountings/Black Iron

Dial 2 – Price & Availability

Dial 3 – Vehicle Application Information, then choose a category:

1 - Plows

2 - Spreaders

Dial 4 – To place a new order

Dial 5 – To check the status of an existing order

Dial 6 – To reach our accounting group

RETAILER HOTLINE IMPORTANT INFORMATION

**216-486-1313 or
800-877-PLOW (7569)**

<input type="text"/>	<input type="text"/>	<input type="text"/>	<input type="text"/>	<input type="text"/>
----------------------	----------------------	----------------------	----------------------	----------------------

Enter your custom PIN # above

***Our caller ID system will recognize calls dialed from a retailer's main phone number and allow instant access to our hotline system. Calls originating from unrecognized phone numbers will require your 5 digit PIN code for access. Fill in the form at the top of this page, or at the front of this Application Guide, to have your PIN code handy at all times.*

This new call routing system is designed exclusively for Meyer Retailers:

- Our Hotline system provides the fastest access to Meyer support.
- Our caller ID system will recognize many phone numbers and allow instant access to the customer support queue, without dialing a PIN.
- This call routing system automatically prioritizes calls from Meyer Retailers; end users do not have access to the system.
- The hotline automatically directs calls to the next available customer support representative.
- Calls directly to individual extensions do not receive priority. Meyer cannot ensure prompt response to calls made to individual extensions, especially during periods of high call volume and in peak calling seasons.

Please do not share your system PIN numbers with end users; this will only lead to delays in our ability to respond to you in a timely fashion.

Get the latest information anytime of the day at www.meyerproducts.com

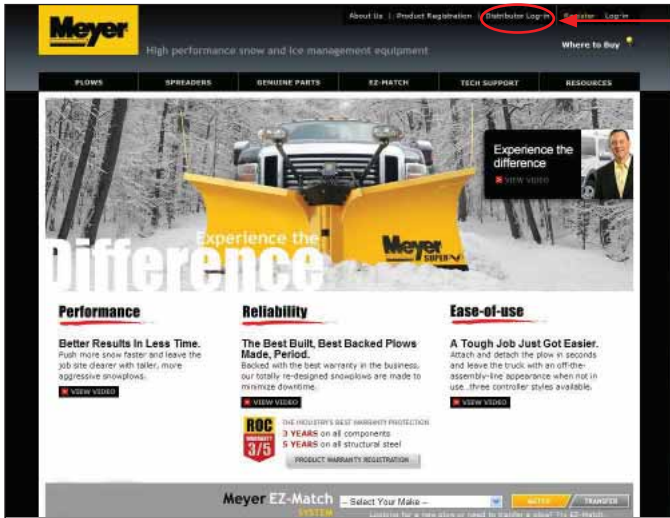

Click here to Log-in to the Extranet

Got to www.meyerproducts.com and click on the Distributor Log-In link.

Enter your username and password and click the Submit button to go to the distributor landing page.



Click on Price & Availability

The distributor landing page provides access to many key areas including:

- Marketing forms and materials
- Product images
- Service and support
- Warranty center
- Ordering and pricing
- Quick Links

Selecting the Price and Availability link in the Quick Links section allows you to see real time pricing and availability for any product or part.

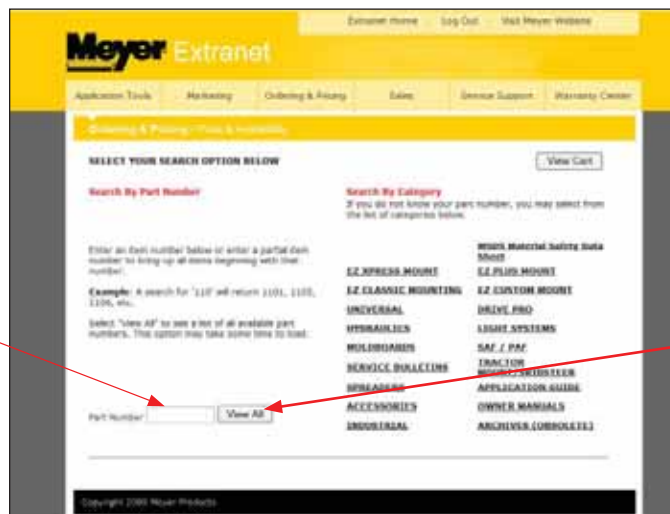

Enter part number here

Then click on View All (DO NOT HIT ENTER)

A part can be found in two ways. One way is to simply enter the part number and click "View All" (**DO NOT HIT ENTER**). Your results will automatically be shown.

The second way is to search the category links on the page to locate and select the correct part number.



Application and Product Guide



Please consult our website www.meyerproducts.com for 24/7 up-to-date application information plus service and installation instructions.

Meyer Products LLC
18513 Euclid Ave.
Cleveland, OH 44112-1084
216-486-1313
www.meyerproducts.com
info@meyerproducts.com

Meyer Products LLC reserves the right, under its continuing product improvement program, to change construction or design details, specifications and prices without notice or without incurring any obligation.

Form No. 2-431 10093.5M

Meyer New Products LLC - East
6 Angell Lane
Damariscotta, ME 04543-9720
207-563-2227
www.meyerproducts.com
info@meyerproducts.com