

CONTROL STATION (ALL STRAIGHT BLADE MODELS)
 JOYSTICK (2000-2002)
 P/N 62073

• NOT DRAWN TO SCALE
 • UNLESS OTHERWISE SPECIFIED ALL DIMENSIONS IN INCHES
 VENDOR P/N: 91-8330-00 REV B (1 OF 6)

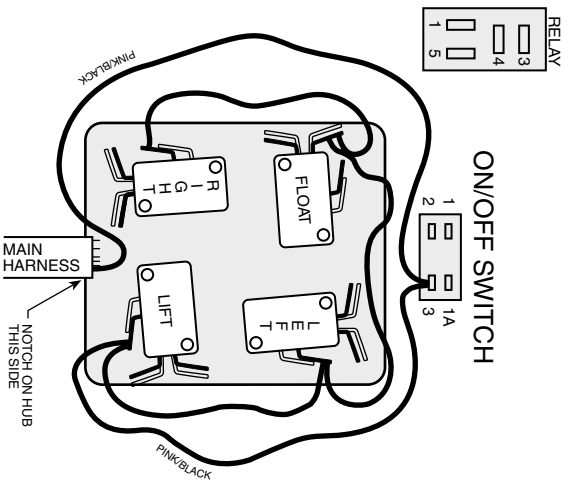

PINK/BLACK WIRE

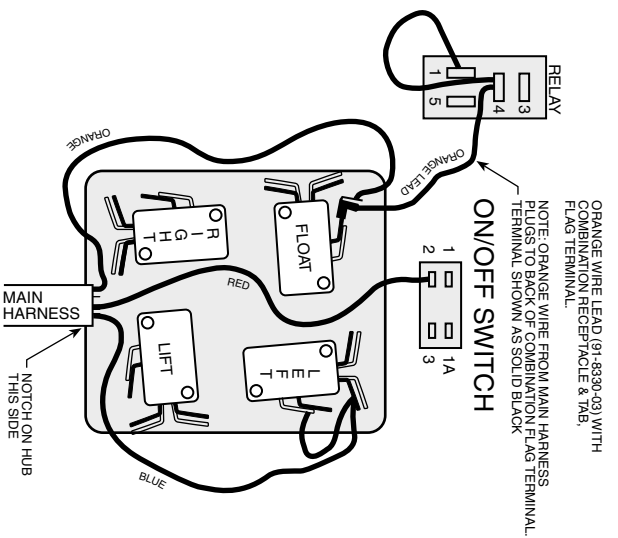

ORANGE, RED & BLUE WIRE & ORANGE LEAD (91-8330-03)

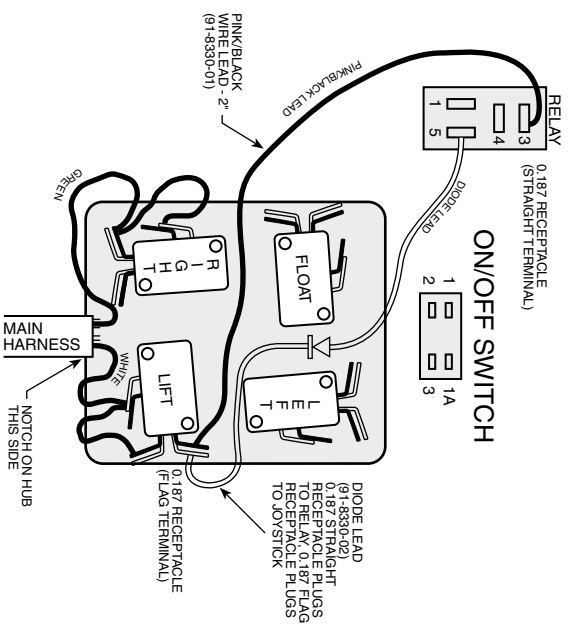

GREEN WIRE, WHITE WIRE PINK/BLACK LEAD (91-8330-01) & DIODE LEAD (91-8330-02)

PIN NO.	COLOR	FUNCTION	AWG
1	N/C	NOT USED	N/A
2	N/C	NOT USED	N/A
3	RED	SWITCH 12 VOLT +	18
4	ORANGE	FLOAT	18
5	N/C	NOT USED	N/A
6	N/C	NOT USED	N/A
7	N/C	NOT USED	N/A
8	WHITE	LIFT	18
9	BROWN	PUMP SOLENOID	18
10	PINK/BLACK	12 (+) DC FUSED	18/20
11	GREEN	RIGHT ANGLE	20
12	BLUE	LEFT ANGLE	20

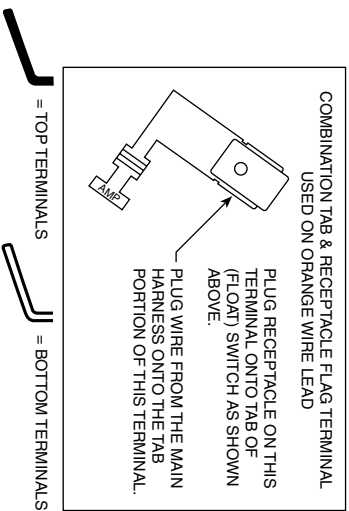

CONTROL STATION (ALL STRAIGHT BLADE MODELS)
WIRING INSTRUCTIONS FOR JOYSTICK - BOTTOM VIEW (2000-2002)
FOR ASSEMBLY P/N 62073

- NOT DRAWN TO SCALE
- UNLESS OTHERWISE SPECIFIED ALL DIMENSIONS IN INCHES

BROWN WIRE

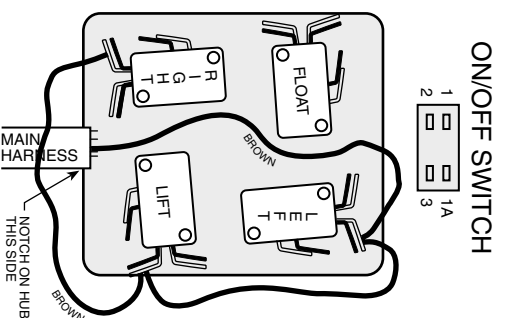



PINK/BLACK WIRE (18 AWG)
2" LONG

CONTROL STATION (ALL STRAIGHT BLADE MODELS)
PINK/BLACK WIRE LEAD FOR JOYSTICK (2000-2002)
FOR ASSEMBLY P/N 62073

- NOT DRAWN TO SCALE
 - UNLESS OTHERWISE SPECIFIED ALL DIMENSIONS IN INCHES
- VENDOR P/N: 91-8330-01 REV B (3 OF 6)

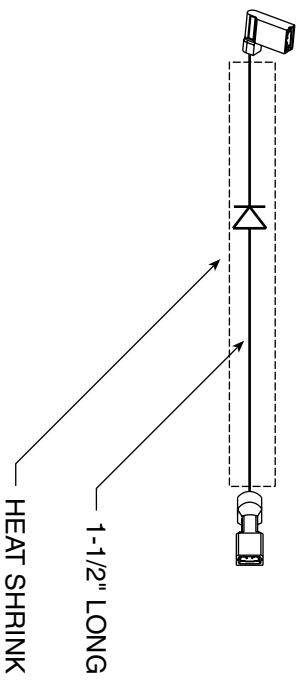

CONTROL STATION (ALL STRAIGHT BLADE MODELS)
DIODE LEAD FOR JOYSTICK (2000-2002)
FOR ASSEMBLY P/N 62073

- NOT DRAWN TO SCALE
 - UNLESS OTHERWISE SPECIFIED ALL DIMENSIONS IN INCHES
- VENDOR P/N: 91-8830-02 REV A (4 OF 6)

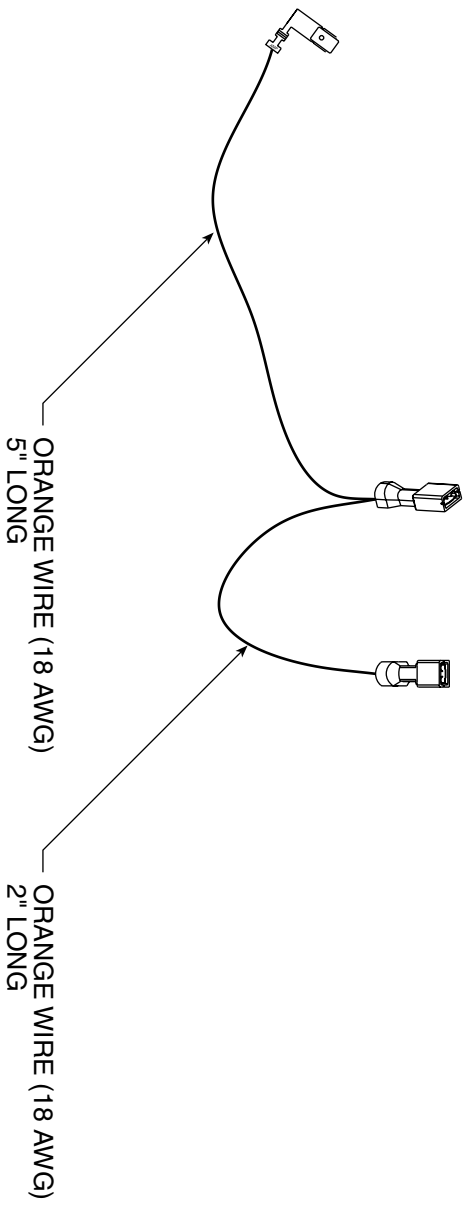

CONTROL STATION (ALL STRAIGHT BLADE MODELS)
ORANGE WIRE LEAD FOR JOYSTICK (2000-2002)
FOR ASSEMBLY P/N 62073

- NOT DRAWN TO SCALE
 - UNLESS OTHERWISE SPECIFIED ALL DIMENSIONS IN INCHES
- VENDOR P/N: 91-8330-03 REV B (5 OF 6)

PIN NO.	COLOR	FUNCTION	AWG
1	N/A	NOT USED	N/A
2	N/A	NOT USED	N/A
3	RED	SWITCH 12 VOLT +	18
4	ORANGE	FLOAT	18
5	N/A	NOT USED	N/A
6	N/A	NOT USED	N/A
7	N/A	NOT USED	N/A
8	WHITE	LIFT	18
9	BROWN	PUMP SOLENOID	18
10	PINK/BLACK	12 (4) DC FUSED	18
11	GREEN	RIGHT ANGLE	NOTE 1
12	BLUE	LEFT ANGLE	NOTE 1

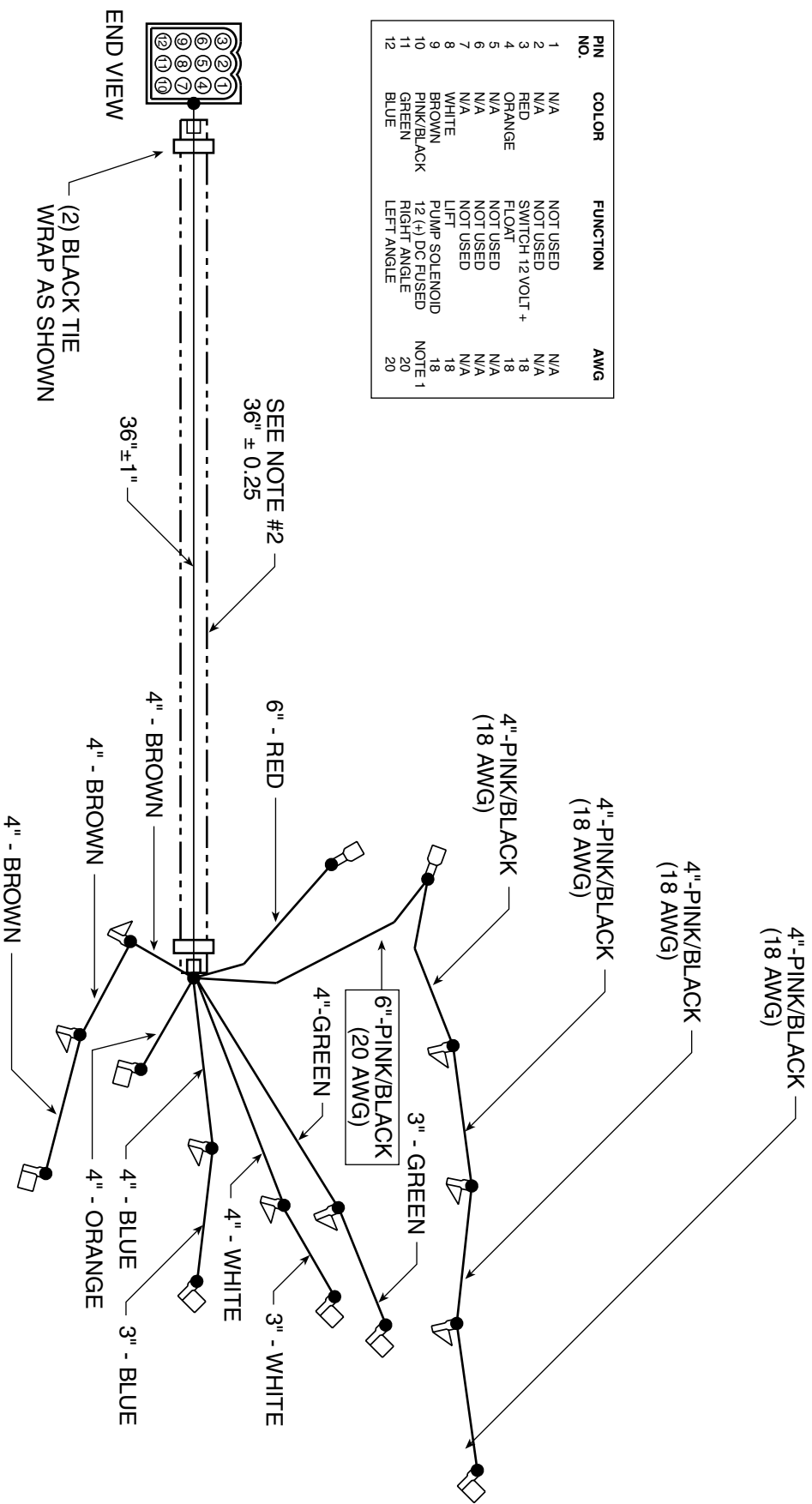

CONTROL STATION (ALL STRAIGHT BLADE MODELS)
MAIN WIRING HARNESS FOR JOYSTICK (2000-2002)
FOR ASSEMBLY P/N 62073

• NOT DRAWN TO SCALE
 • UNLESS OTHERWISE SPECIFIED ALL DIMENSIONS IN INCHES
 VENDOR P/N: 91-8330-05 REV A (6 OF 6)