

ON/OFF SWITCH & ON/OFF/ON SWITCH (SHOWN FROM BACK VIEW) MOUNTS TO SIDE OF SWITCH BOX. POSITION 1 ON BOTH SWITCHES IS MOUNTED TOWARD FACE OF SWITCH BOX.

ON/OFF

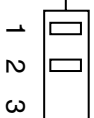

ON/OFF/ON

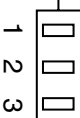

[ON]-OFF-[ON]

BACK VIEW  
LOOKING AT  
INSIDE OF  
SWITCH BOX

COLOR	FUNCTION
RED/WHITE	RIGHT BOX EXTEND
RED/BLACK	RIGHT BOX RETRACT
RED	SWITCH 12 VOLT +
ORANGE	FLOAT
BLUE/WHITE	LEFT BOX EXTEND
BLUE/BLACK	LEFT BOX RETRACT
WHITE	LIFT
BROWN	PUMP SOLENOID
PINK/BLACK	12 (+) DC FUSED
GREEN	RIGHT ANGLE
BLUE	LEFT ANGLE
BLACK	GROUND

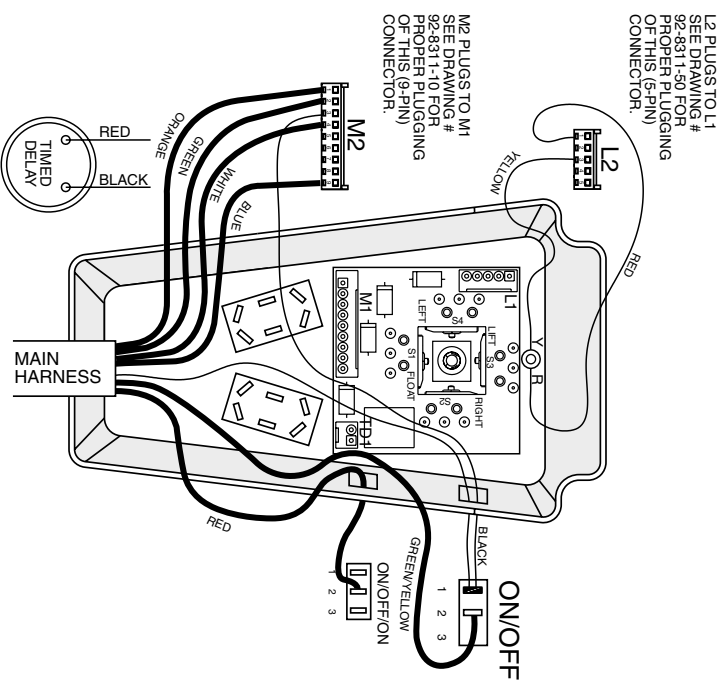

WHITE, BLUE, GREEN, ORANGE,  
BLACK, RED, GREEN/YELLOW WIRES, &  
L.E.D. HARNESS (SEE DRAWING 92-8311-50)

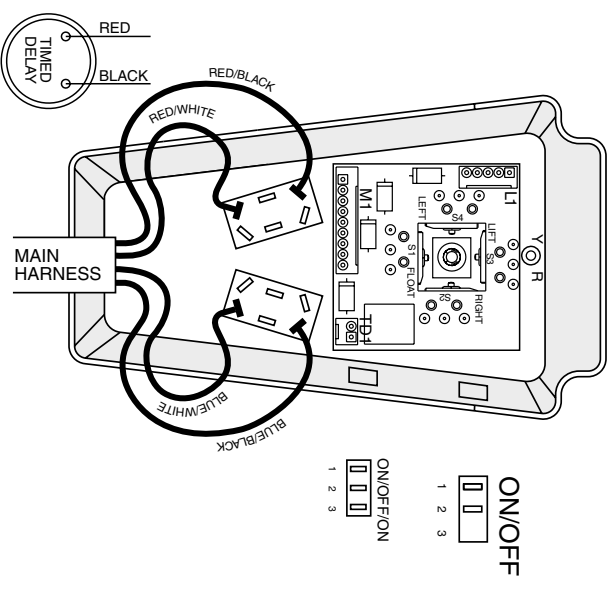

RED/BLACK, RED/WHITE,  
BLUE/BLACK & BLUE/WHITE  
WIRES

**CONTROL STATION (MODELS 810 & 8611)**  
WIRING INSTRUCTIONS FOR JOYSTICK (2003)  
FOR ASSEMBLY P/N 62109

• NOT DRAWN TO SCALE  
• UNLESS OTHERWISE SPECIFIED ALL DIMENSIONS IN INCHES  
VENDOR DWG#: (REF. M.P.M. 92-8311-WL REV D) - (1 OF 9)

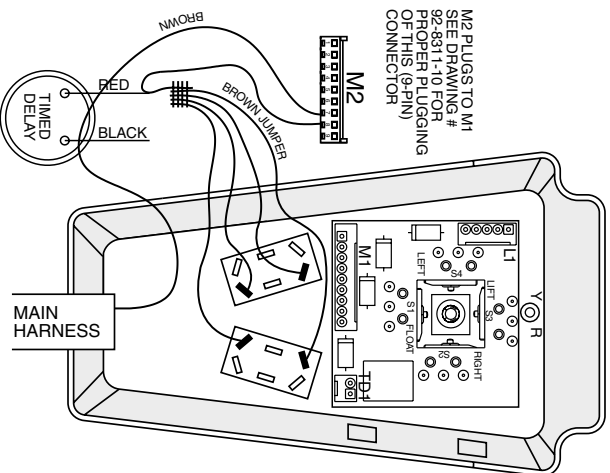

**BROWN WIRE & BROWN JUMPER**  
(92-8311-13)

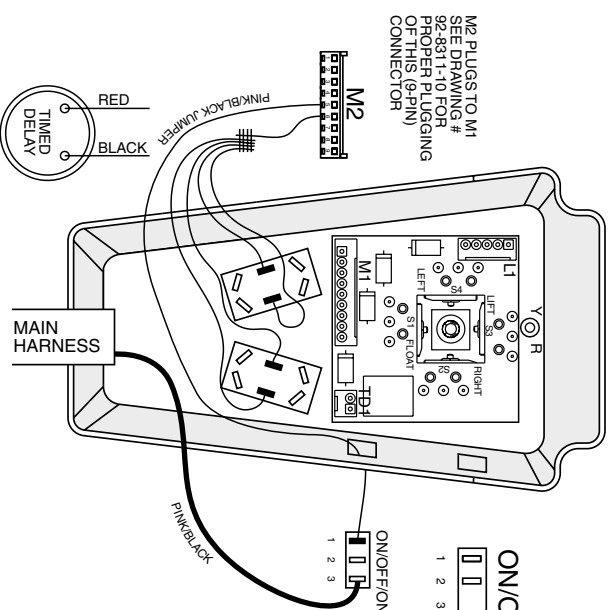

**PINK/BLACK WIRE & PINK/BLACK JUMPERS**  
92-8311-11 & 92-8311-12

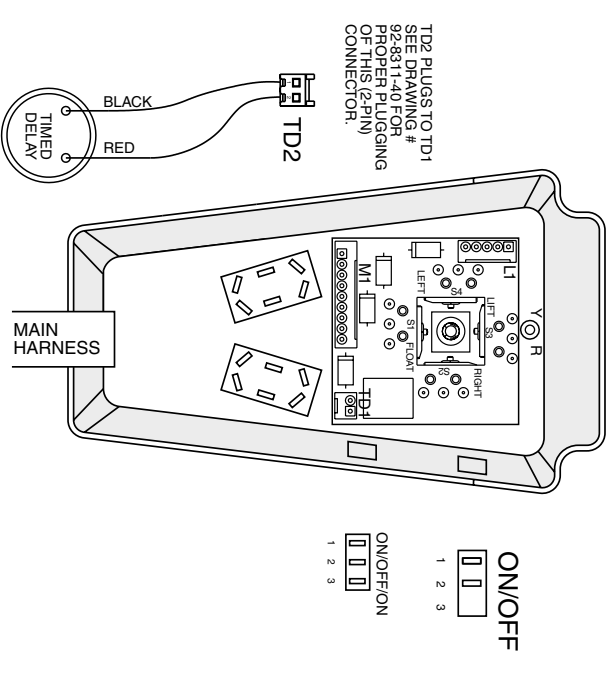

**TIME DELAY HARNESS**  
92-8311-40

**CONTROL STATION (MODELS 810 & 8611)**  
**WIRING INSTRUCTIONS FOR JOYSTICK (2003)**  
**FOR ASSEMBLY P/N 62109**

- NOT DRAWN TO SCALE
  - UNLESS OTHERWISE SPECIFIED ALL DIMENSIONS IN INCHES
- VENDOR DWG#: (REF M.P.M. 92-8311-WL REV D) - (2 OF 9)

COLOR	FUNCTION
RED/WHITE	RIGHT BOX EXTEND
RED/BLACK	RIGHT BOX RETRACT
RED	SWITCH 12 VOLT +
ORANGE	FLOAT
BLUE/WHITE	LEFT BOX EXTEND
BLUE/BLACK	LEFT BOX RETRACT
WHITE	LIFT
BROWN	PUMP SOLENOID
PINK/BLACK	12 (+) DC FUSED
GREEN	RIGHT ANGLE
BLUE	LEFT ANGLE
BLACK	GROUND

**BACK VIEW**  
**LOOKING AT**  
**INSIDE OF**  
**SWITCH BOX**

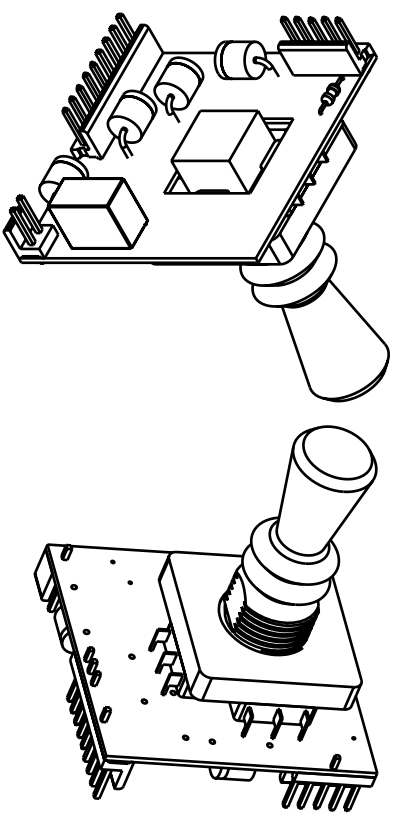
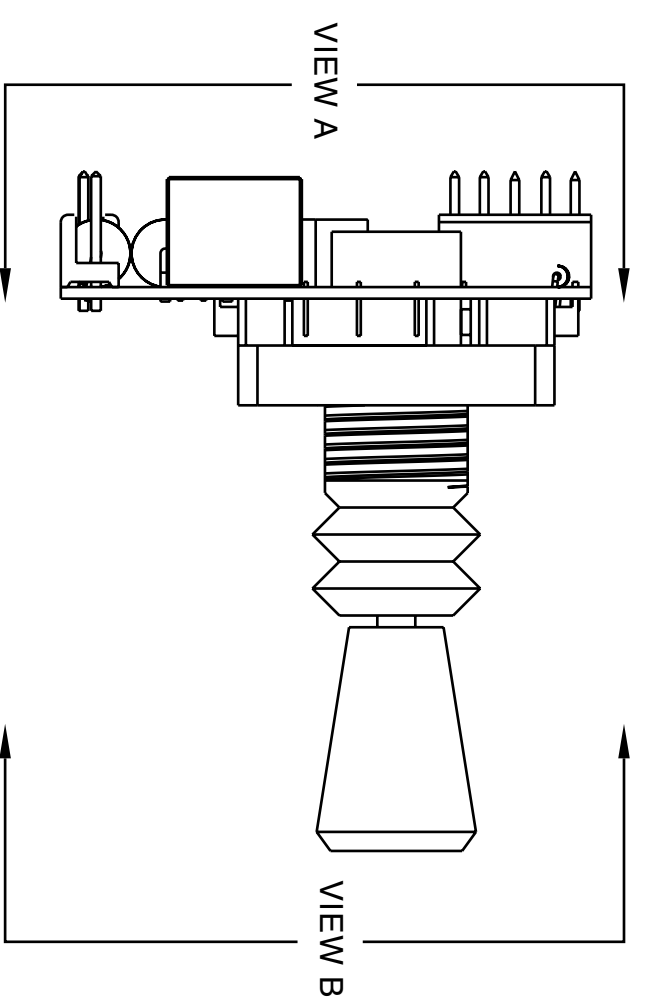
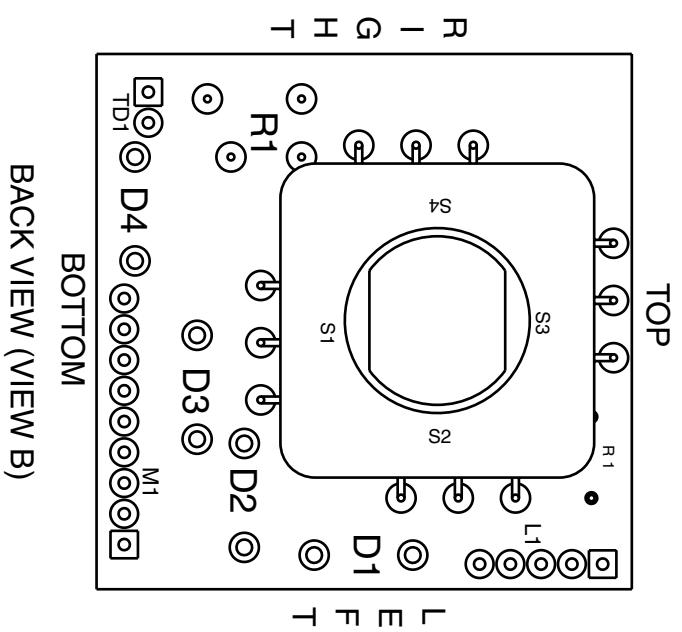
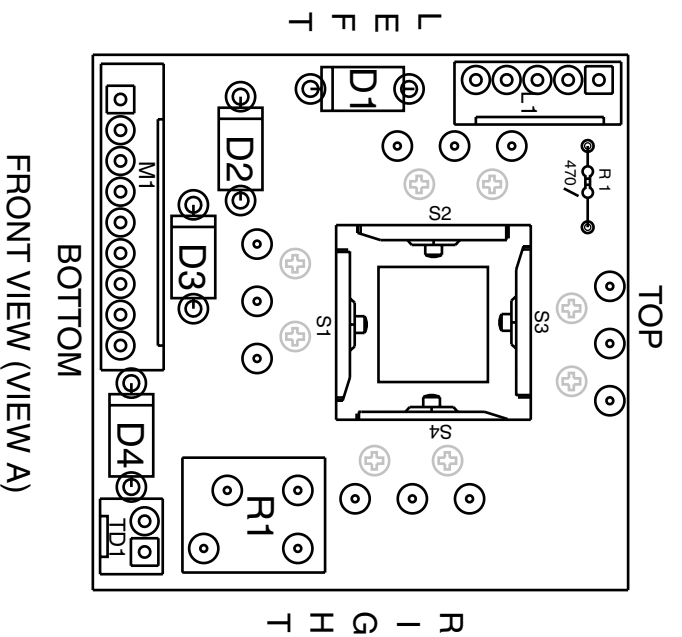

EITHER FLAT AREA (X2), OF THREADED SECTION OF JOYSTICK, MUST BE FACING TOWARD TOP OF CIRCUIT BOARD WHEN MOUNTED.

SCREWS GO THROUGH FRONT OF CIRCUIT BOARD, THROUGH SWITCHES (X4), AND INTO HOLES ON BOTTOM OF JOYSTICK.

**CONTROL STATION (MODELS 810 & 8611)**  
 CIRCUIT BOARD LAYOUT (2003)  
 FOR ASSEMBLY P/N 62109

• NOT DRAWN TO SCALE  
 • UNLESS OTHERWISE SPECIFIED ALL DIMENSIONS IN INCHES  
 VENDOR DWG#: (REF: M.P.M. 92-831-1-WL REV D) - (3 OF 9)

PIN NO.	COLOR	FUNCTION	AWG
1	RED/WHITE	RIGHT BOX EXTEND	18
2	RED/BLACK	RIGHT BOX RETRACT	18
3	RED	RIGHT BOX 12 VOLT +	18
4	ORANGE	FLOAT	18
5	BLUE/WHITE	LEFT BOX EXTEND	18
6	LT. BLUE/BLACK	LEFT BOX RETRACT	18
7	BLACK	RELAY GROUND	18
8	WHITE	LIFT	18
9	BROWN	PUMP SOLENOID	18
10	PINK/BLACK	12 (+) DC FUSED	18
11	GREEN	RIGHT ANGLE	18
12	BLUE	LEFT ANGLE	18

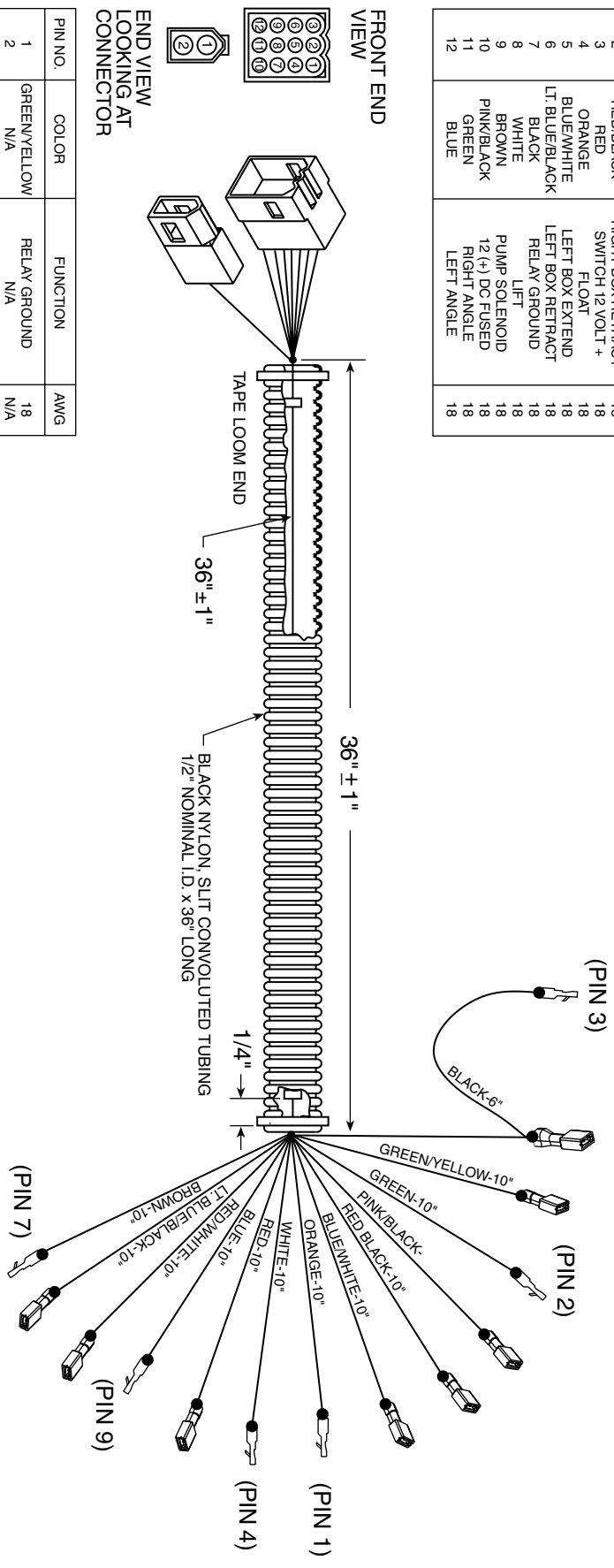

PIN NO.	COLOR	FUNCTION	AWG
1	GREEN/YELLOW	RELAY GROUND	18
2	N/A	N/A	N/A

**CONTROL STATION (MODELS 810 & 8611)**  
**MAIN WIRING HARNESS FOR JOYSTICK (2003)**  
**FOR ASSEMBLY P/N 62109**

- NOT DRAWN TO SCALE
- UNLESS OTHERWISE SPECIFIED ALL DIMENSIONS IN INCHES
- VENDOR DWG#: (REF. M.P.M. 92-831-1-10 REV D) - (4 OF 9)

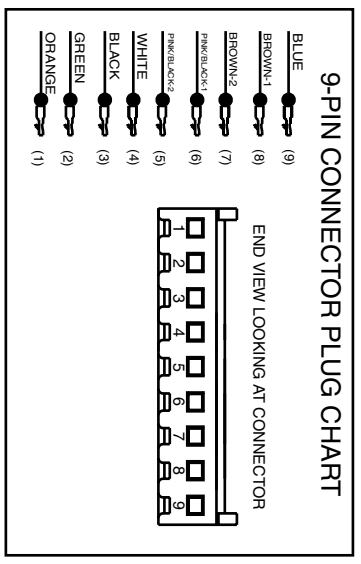

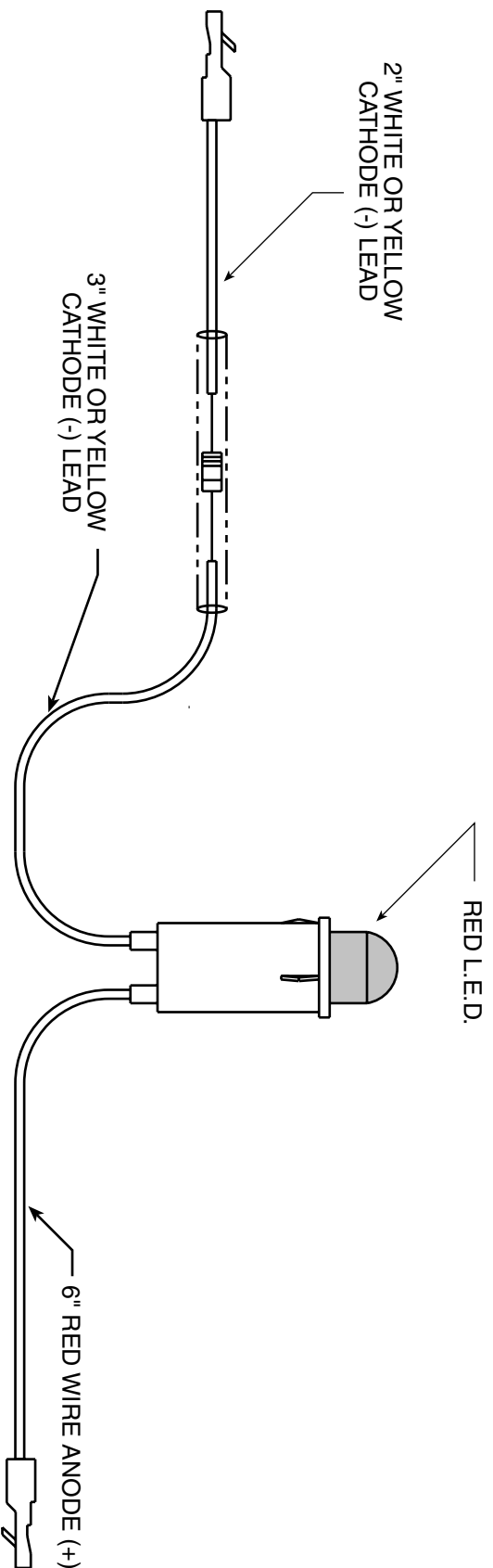
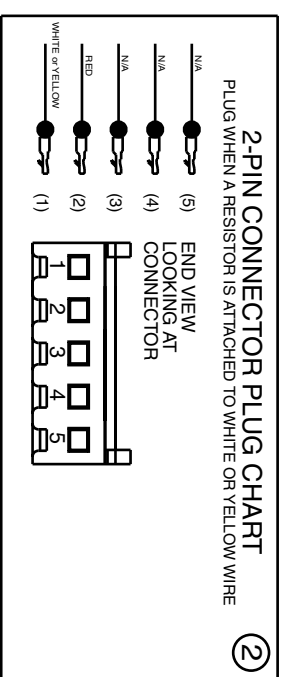
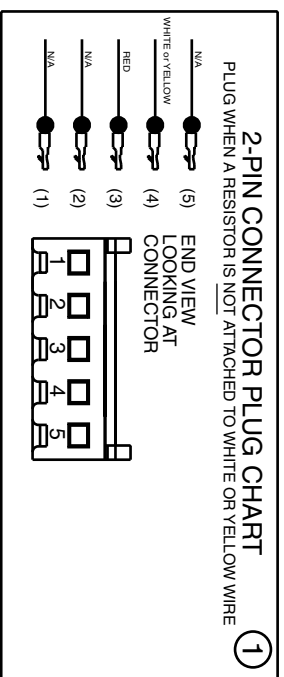

**ONTROL STATION (MODELS 810 & 8611)**  
 L.E.D. WIRE HARNESS FOR JOYSTICK (2003)  
 FOR ASSEMBLY P/N 62109

- NOT DRAWN TO SCALE
  - UNLESS OTHERWISE SPECIFIED ALL DIMENSIONS IN INCHES
- VENDOR DWG#: (REF. M.P.M. 92-831-1-50) - (5 OF 9)

9-PIN CONNECTOR PLUG CHART

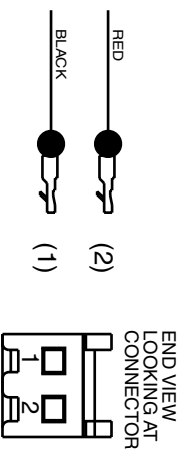

USE EXISTING WIRE LENGTHS

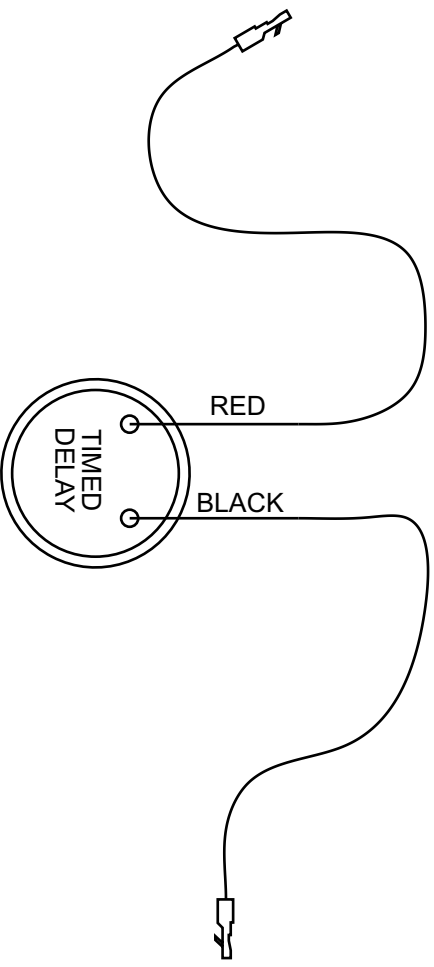

**CONTROL STATION (MODELS 810 & 8611)**  
TIME DELAY WIRING HARNESS FOR JOYSTICK (2003)  
FOR ASSEMBLY P/N 62109

- NOT DRAWN TO SCALE
  - UNLESS OTHERWISE SPECIFIED ALL DIMENSIONS IN INCHES
- VENDOR DWG#: (REF. M.P.M. 92-8311-40 REV C) - (6 OF 9)

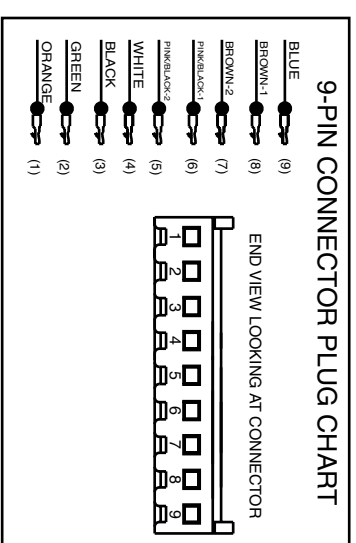
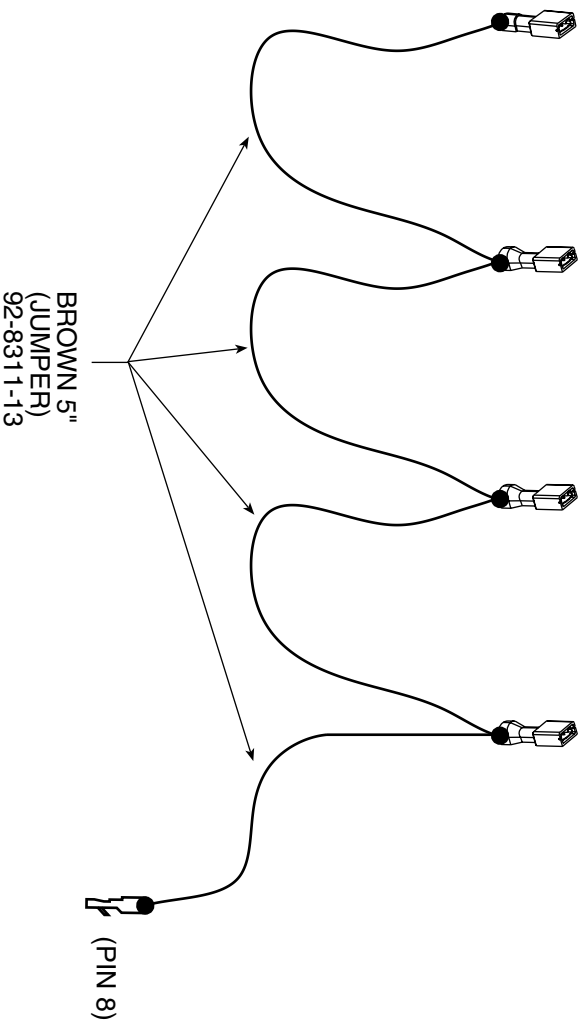

**CONTROL STATION (MODELS 810 & 8611)**  
**BROWN SECONDARY HARNESS FOR JOYSTICK (2003)**  
 FOR ASSEMBLY P/N 62109

- NOT DRAWN TO SCALE
  - UNLESS OTHERWISE SPECIFIED ALL DIMENSIONS IN INCHES
- VENDOR DWG#: (REF. M.P.M. 92-8311-13 REV A) - (7 OF 9)

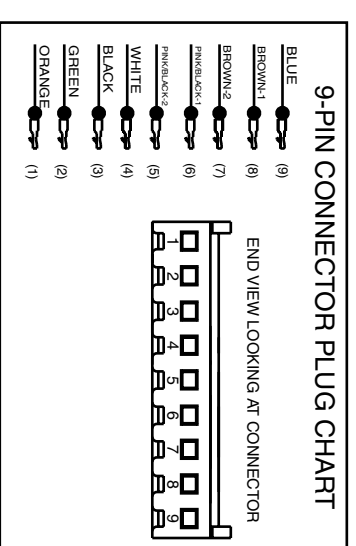
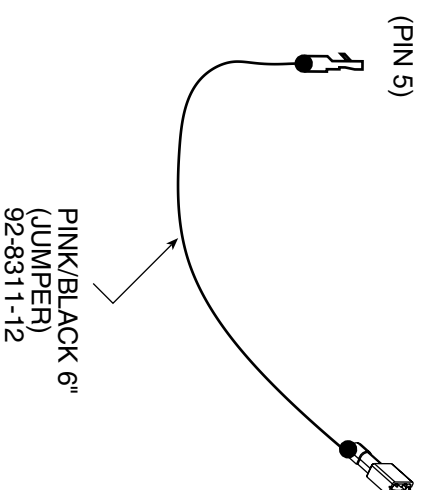

**CONTROL STATION (MODELS 810 & 8611)**  
**PINK/BLACK SWITCH JUMPER HARNESS FOR JOYSTICK (2003)**  
**FOR ASSEMBLY P/N 62109**

- NOT DRAWN TO SCALE
  - UNLESS OTHERWISE SPECIFIED ALL DIMENSIONS IN INCHES
- VENDOR DWG#: (REF. M.P.M. 92-8311-12 REV A) - (8 OF 9)

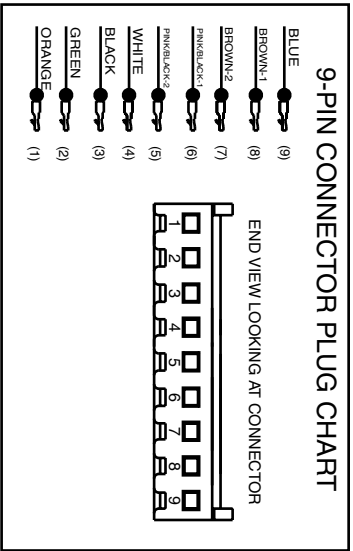
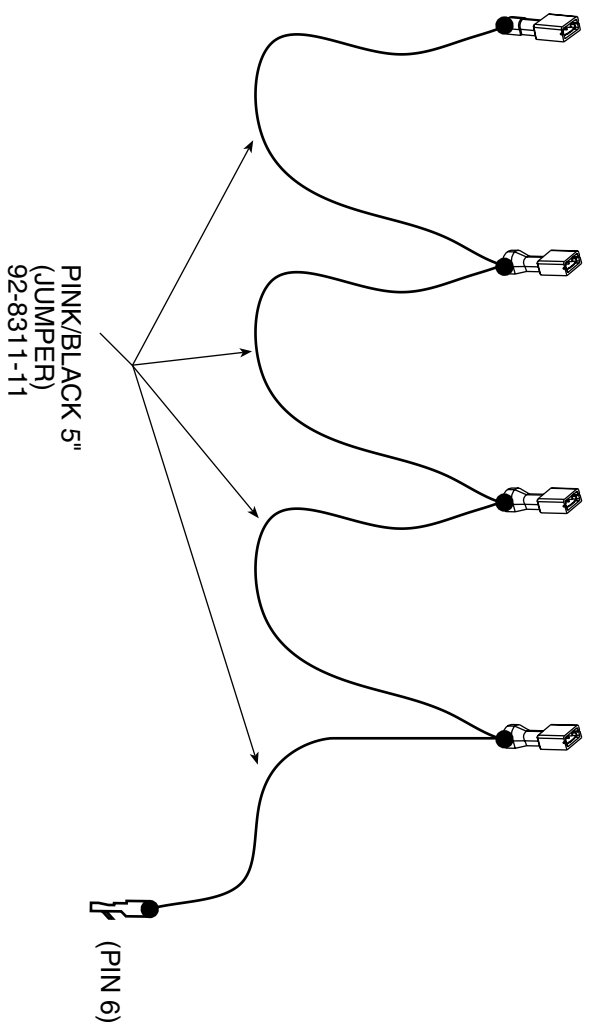

**CONTROL STATION (MODELS 810 & 8611)**  
**PINK/BLACK SECONDARY HARNESS FOR JOYSTICK (2003)**  
**FOR ASSEMBLY P/N 62109**

• NOT DRAWN TO SCALE  
 • UNLESS OTHERWISE SPECIFIED ALL DIMENSIONS IN INCHES  
 VENDOR DWG#: (REF. M.P.M. 92-8311-11 REV A) - (9 OF 9)