

# 1223 TRUCK MOUNT

## Installation Instructions for Personal Plow

<b>Ford F150</b>	<b>1997 – 2003</b>
<b>Ford Expedition</b>	<b>1997 – 2002</b>

**⚠ CAUTION**

Read this document before installing the snowplow.

**⚠ CAUTION**

See your sales outlet for application recommendations. The Kit Selection Guide/ Selection List has specific vehicle and snowplow requirements.

**SAFETY DEFINITIONS**

**⚠ WARNING**

Indicates a potentially hazardous situation that, if not avoided, could result in death or serious personal injury.

**⚠ CAUTION**

Indicates a situation that, if not avoided, could result in damage to product or property.

**NOTE:** Identifies tips, helpful hints, and maintenance information the owner/operator should know.

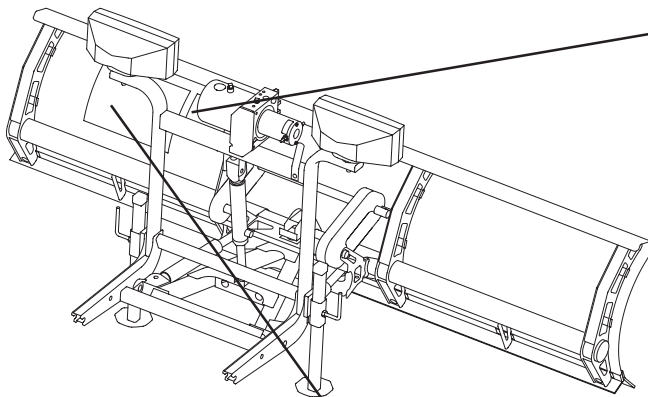

**WARNING/CAUTION AND INSTRUCTION LABELS**

Become familiar with and inform users about the warning label and instruction label on the back of the blade.

**Warning and Caution Label**

**⚠ WARNING**

LOWER BLADE WHEN VEHICLE IS PARKED.  
 REMOVE BLADE ASSEMBLY BEFORE PLACING VEHICLE ON HOIST.  
 DO NOT EXCEED GVWR OR GAWR INCLUDING BLADE AND BALLAST.

---

**⚠ CAUTION**

READ *OWNER'S MANUAL* BEFORE OPERATING OR SERVICING SNOWPLOW.  
 TRANSPORT SPEED SHOULD NOT EXCEED 45 MPH. REDUCE SPEED UNDER ADVERSE TRAVEL CONDITIONS.  
 PLOWING SPEED SHOULD NOT EXCEED 10 MPH.  
 SEE YOUR SALES OUTLET FOR APPLICATION RECOMMENDATIONS.

**Instruction Label**

***This snowplow is for personal/homeowner use only.***

**ATTACH INSTRUCTIONS**

1. Make certain both **connecting pins** are fully retracted.
2. Drive vehicle slowly to completely insert **attachment arms** into **receiver assembly** slots.
3. Twist both **connecting pins** to release spring tension, then push **plow gear** toward vehicle so **connecting pins** fully engage holes in **attachment arms**.
4. Loosen one **jack handle** and slide **jack sleeve** down below **jack retainer**. Remove **jack** and retighten **jack handle**. Repeat for other **jack** and store them.
5. Connect all electrical cables from vehicle to snowplow.

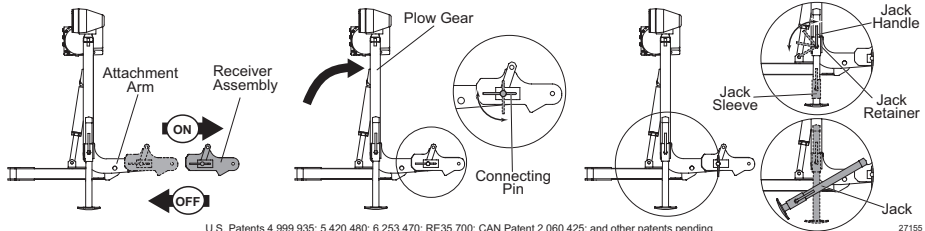

U.S. Patents 4,999,935; 5,420,480; 6,253,470; RE35,700; CAN Patent 2,060,425; and other patents pending.

27155

**DETACH INSTRUCTIONS**

5. Back vehicle away from snowplow.
6. See Owner's Manual for proper snowplow storage.
3. While pushing **plow gear** toward vehicle to release **connecting pin** tension, pull **connecting pin** out on one side and twist pin handle to keep pin retracted. Repeat procedure for other **connecting pin**.
4. Disconnect all electrical cables.
1. Put blade on ground using **LOWER/FLOAT** on snowplow control. Leave control **ON** and in **FLOAT**.
2. Attach **jacks**. Loosen **jack handle**, put **jack** on ground, and raise **jack sleeve** until fully engaging **jack retainer**. Tighten **jack handle**. Repeat for other **jack**.

Read *Owner's Manual* for Complete Instructions

## SAFETY PRECAUTIONS

Improper installation and operation could cause personal injury and/or equipment and property damage. Read and understand labels and the *Owner's Manual* before installing, operating, or making adjustments.

### **⚠ WARNING**

**Lower blade when vehicle is parked. Temperature changes could change hydraulic pressure, causing the blade to drop unexpectedly or damaging hydraulic components. Failure to do this can result in serious personal injury.**

### **⚠ WARNING**

**Remove blade assembly before placing vehicle on hoist.**

### **⚠ WARNING**

**The driver shall keep bystanders clear of the blade when it is being raised, lowered, or angled. Do not stand between the vehicle and the blade or within 8 feet of a moving blade. A moving or falling blade could cause personal injury.**

### **⚠ WARNING**

**Keep hands and feet clear of the blade and A-frame when mounting or removing the snowplow. Moving or falling assemblies could cause personal injury.**

### **⚠ WARNING**

**Do not exceed GVWR or GAWR including blade and ballast. The rating label is found on driver-side vehicle door cornerpost.**

### **⚠ CAUTION**

**Refer to the Kit Selection Guide/Selection List for minimum vehicle recommendations and ballast requirements.**

### **⚠ CAUTION**

**To prevent accidental movement of the blade, always turn the ON/OFF switch to OFF whenever the snowplow is not in use. The control indicator light will turn off.**

## PERSONAL SAFETY

- Wear only snug-fitting clothing while working on your vehicle or snowplow.
- Do not wear jewelry or a necktie, and secure long hair.
- Wear safety goggles to protect your eyes from battery acid, gasoline, dirt, and dust.
- Avoid touching hot surfaces such as the engine, radiator, hoses, and exhaust pipes.
- Always have a fire extinguisher rated BC handy, for flammable liquids and electrical fires.

## FIRE AND EXPLOSION

### **⚠ WARNING**

**Gasoline is highly flammable and gasoline vapor is explosive. Never smoke while working on a vehicle. Keep all open flames away from gasoline tanks and lines. Wipe up any spilled gasoline immediately.**

Be careful when using gasoline. Do not use gasoline to clean parts. Store only in approved containers away from sources of heat or flame.

## VENTILATION



### **⚠ WARNING**

**Vehicle exhaust contains deadly carbon monoxide (CO) gas. Breathing this gas, even in low concentrations, could cause death. Never operate a vehicle in an enclosed area without venting exhaust to the outside.**

**TORQUE CHART**

**⚠ CAUTION**

**Read instructions before assembling. Fasteners should be finger tight until instructed to tighten according to the torque chart. Use standard methods and practices when attaching snowplow including wearing proper personal protective safety equipment.**

<b>Recommended Fastener Torque Chart (Ft.-Lb.)</b>			
Size	 SAE Grade 2	 SAE Grade 5	 SAE Grade 8
1/4-20	6	9	13
5/16-18	11	18	28
3/8-16	19	31	46
3/8-24	24	46	68
7/16-14	30	50	75
1/2-13	45	75	115
9/16-12	66	110	165
5/8-11	93	150	225
3/4-10	150	250	370
7/8-9	150	378	591
1-8	220	583	893
<b>Metric Grade 8.8 (Ft.-Lb.)</b>			
Size	Torque	Size	Torque
M 6	7	M 12	60
M 8	17	M 14	95
M 10	35	M 16	155
These torque values apply to fasteners except those noted in the instruction.			

## INSTALLATION INSTRUCTIONS

1. Remove the bumper/air dam assembly from the front of the frame by removing the two bolts on each side of the frame. Disconnect the fog lights if equipped. Retain the fasteners.
2. Remove both tow hooks from the front of the frame and retain the fasteners and bolting bars. The tow hooks cannot be used with the mount installed. Retain the tow hooks for reinstallation if the snowplow is removed.
3. If a skid plate is installed, remove it and trim as described in the following illustration. Remove and discard the two cage nuts and screws that correspond to the trimmed portion of the skid plate. Reinstall the skid plate using the remaining four cage nuts and screws.

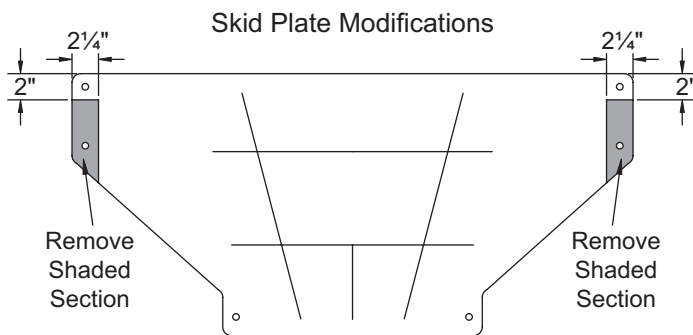

4. Position the mount under the vehicle frame. Line up the slotted holes with the tow hook holes in the frame. Reusing the tow hook fasteners and bolting bars, install the mount to the bottom of the frame and hand tighten.
5. Push the rear supports up against the bottom of the frame and clamp in place. Using the two upper holes in the rear supports as guides, drill two 17/32" holes in the vehicle frame.

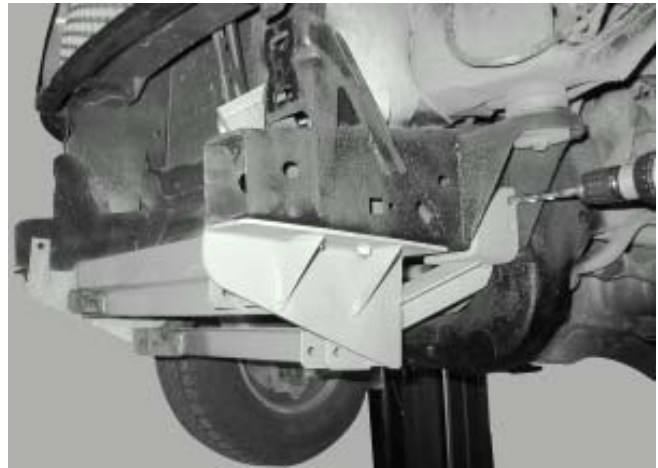

6. Place a 1/2" washer onto a 1/2" bolt with handle and insert the bolt into the truck frame. Pass the bolt out through the hole in the truck frame and the hole in the rear support. Place a 1/2" locknut on the bolt and tighten all of the fasteners.
7. Using the two holes in the front tab of the mount as guides, drill two 17/32" holes in the vehicle frame.
8. Insert a 1/2" cap screw through each front tab and into the frame. Place a 1/2" washer and locknut inside the frame; otherwise, the bumper will not reattach. Tighten these fasteners.
9. Reinstall the bumper/air dam assembly and fog light connectors. Trim air dam as required.

---

**NOTE: After five to ten hours of snowplow usage, retorque all mount assembly fasteners.**

---

The company reserves the right under its product improvement policy to change construction or design details and furnish equipment when so altered without reference to illustrations or specifications used. Do not exceed vehicle ratings with a snowplow. The company offers a limited warranty for all snowplows. See separately printed page for this important information.

**Printed in U.S.A.**