

Parts & Installation Instructions

16503 S.A.F. Carton

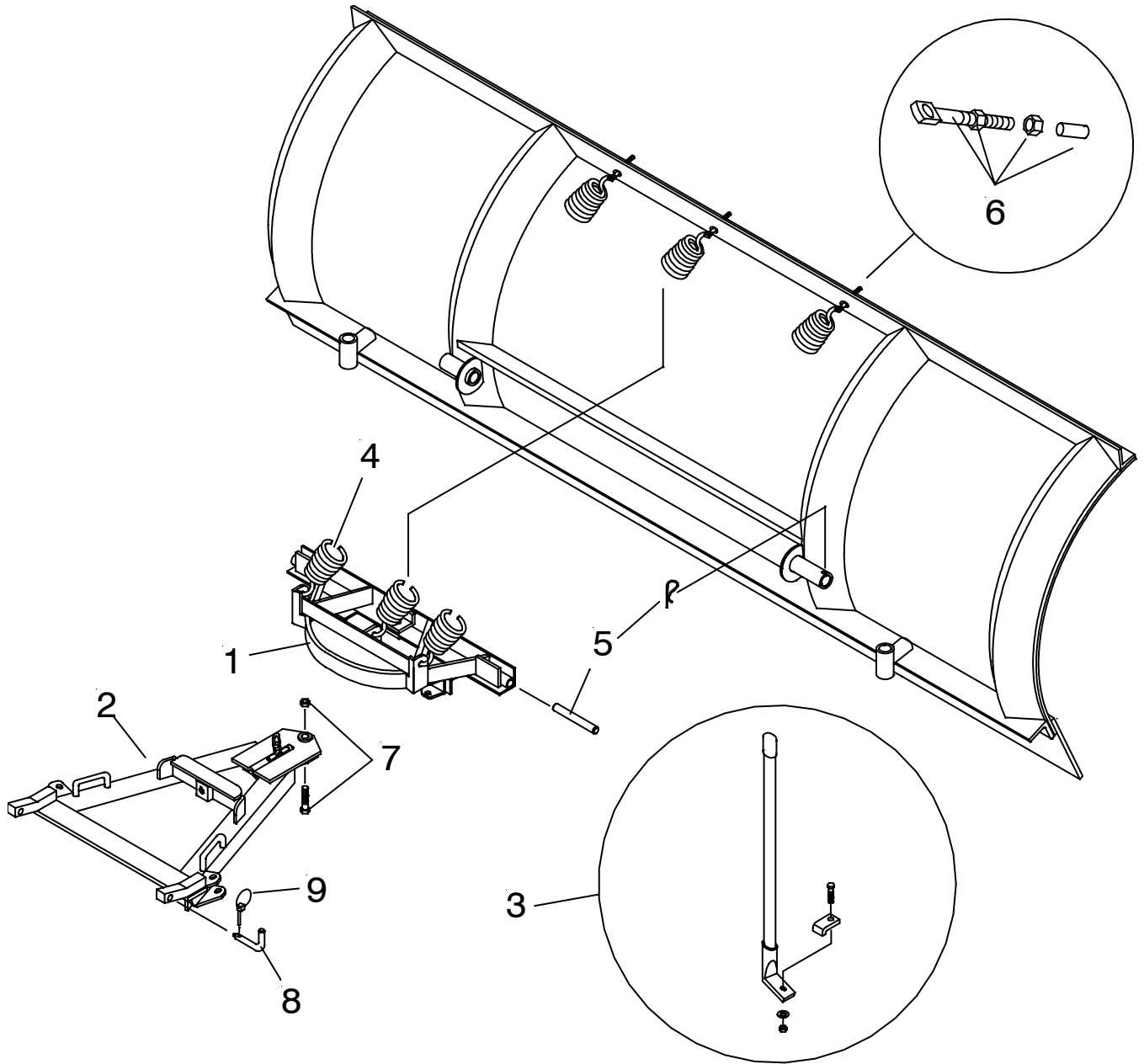

Parts List

Item	Part No.	Qty	Description
	16503	1	Sector A-Frame Carton
1	12326	1	• Sector
2	13607	1	• A-Frame 11" x 31" x 23.5"
3	09116	1	• Plow Marker Kit
4	07017	3	• Trip Spring
	08166	1	• Hardware Bag
5	09119	2	•• Pivot Pin w/ Fttg & Hair Pin
6	09124	3	•• Eye Bolt w/ Locknut & Cap
7	09122	1	•• King Bolt w/ Locknut
8	11101	2	•• Hinge Pin
9	22083	2	•• Linch Pin