

# Parts & Installation Instructions

## 16507 S.A.F. Carton

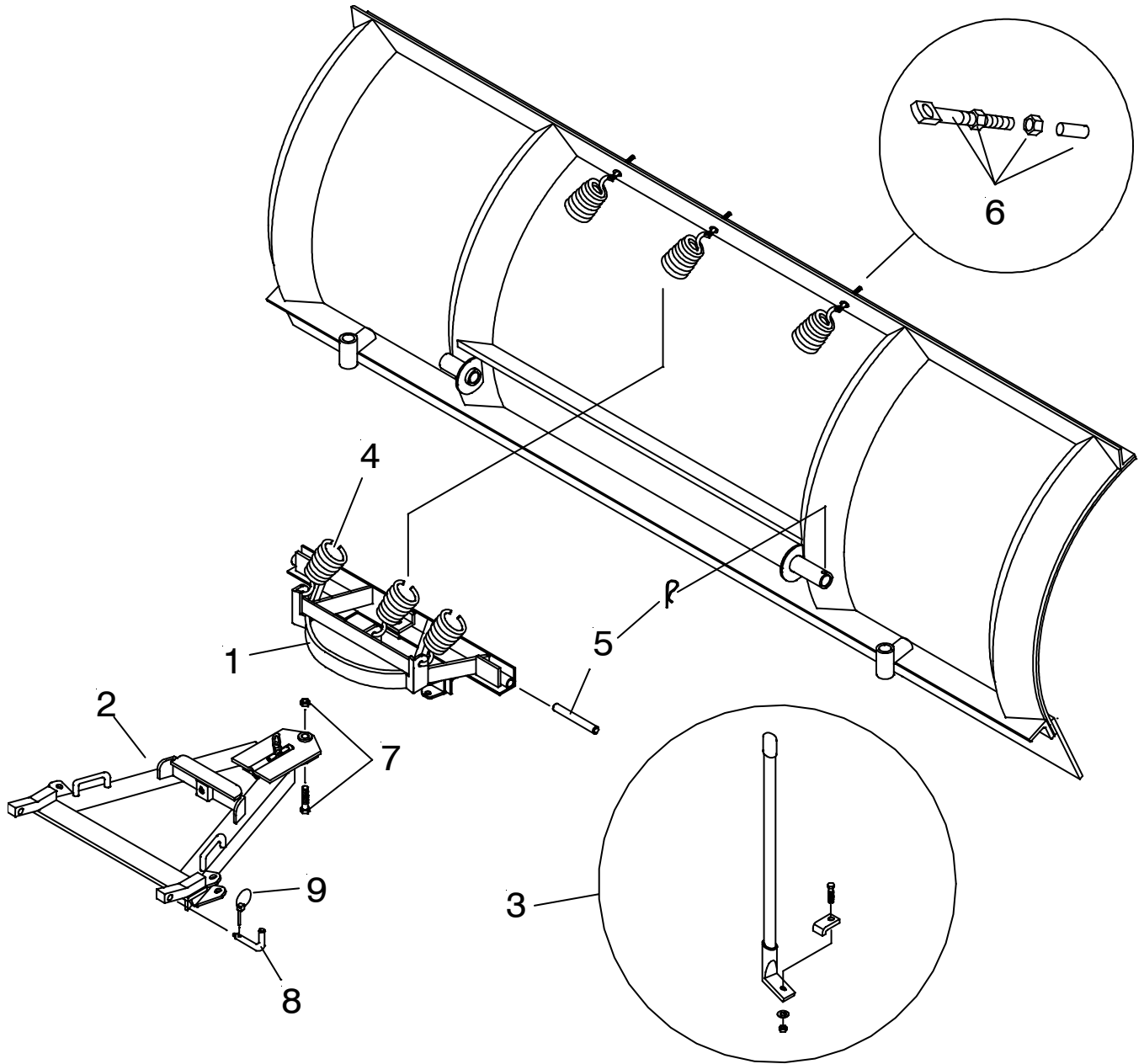

### Parts List

Item	Part No.	Qty	Description
	16507	1	<b>Sector A-Frame Carton</b>
1	12182	1	• Sector
2	13635	1	• A-Frame 11" x 34" x 23.5"
3	09116	1	• Plow Marker Kit
4	07017	3	• Trip Spring
	08166	1	• <b>Hardware Bag</b>
5	09119	2	•• Pivot Pin w/ Fttg & Hair Pin
6	09124	3	•• Eye Bolt w/ Locknut & Cap
7	09122	1	•• King Bolt w/ Locknut
8	11101	2	•• Hinge Pin
9	22083	2	•• Linch Pin