

Parts & Installation Instructions 16480 S.A.F. Carton

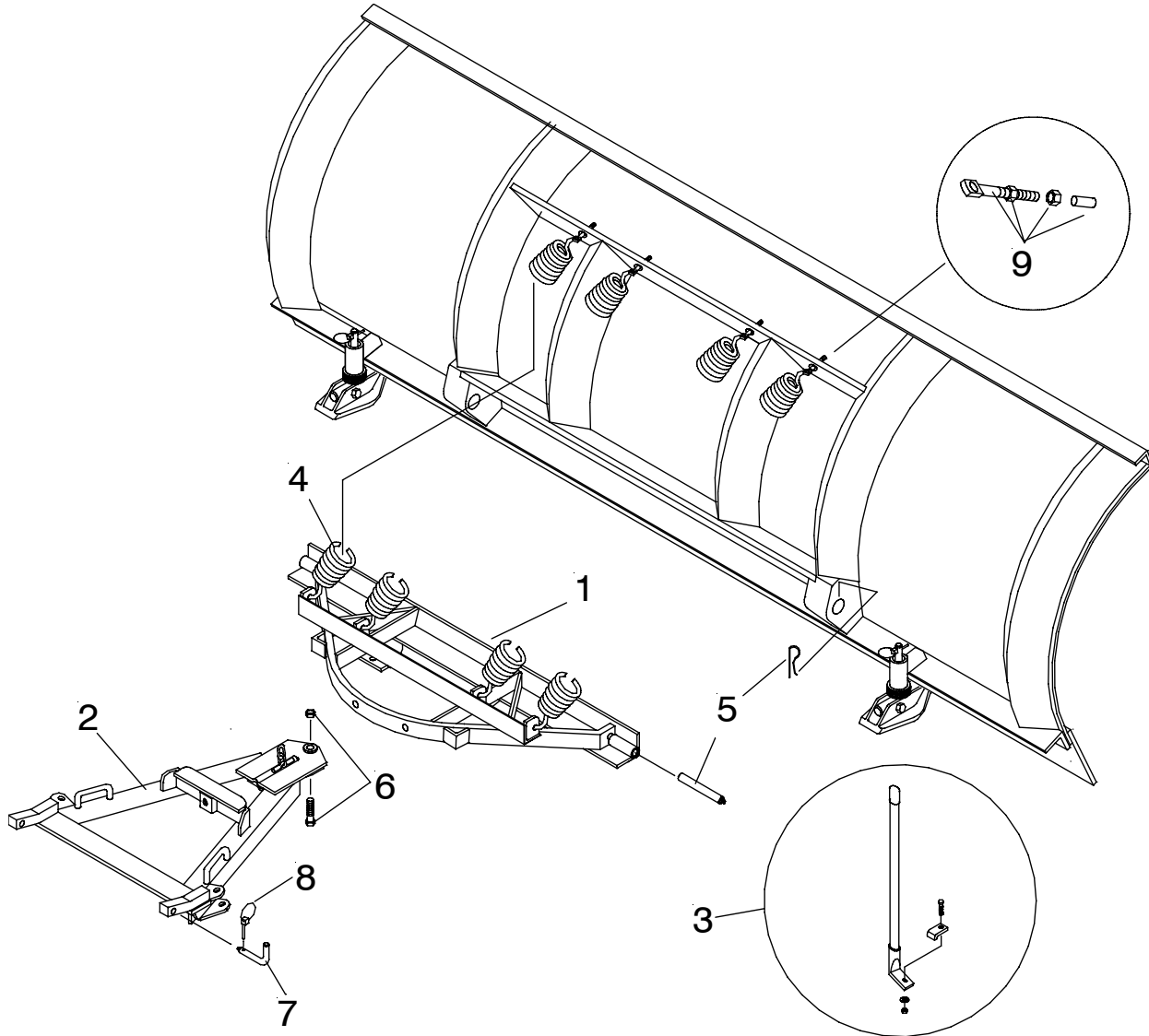

Parts List

Item	Part No.	Qty.	Description
	16479	1	Sector & A-Frame Carton
1	12793	1	• Sector
2	13559	1	• A-Frame 15" x 31" x 23-1/2"
3	09916	1	• Marker Kit
4	07017	4	• Trip Spring
	08341	1	• Hardware Bag
5	09119	2	•• Pivot Pin w/ Fittg. & Hair Pin
6	09125	1	•• King Bolt w/ Locknut
7	11101	2	•• Hinge Pin
8	22083	2	•• Lynch Pin
9	09124	4	•• Eye Bolt w/ Locknut & Cap