

## PARTS & INSTALLATION INSTRUCTIONS

### DRIVE PRO™





## SNOW PLOW MOUNTING CARTON 18515

## 2007 thru 2010 VOLKSWAGEN T-5 4x4 MODELS

### Residential Use Only



End user must be given this instruction sheet prior to delivery of Snow Plow.

#### SAFETY DEFINITIONS



|   |  |
|---|--|
|  | This is the safety alert symbol. It is used to alert you to potential personal injury hazards. Obey all safety messages that follow this symbol to avoid possible injury or death. |
|  | DANGER Indicates an imminently hazardous situation which, if not avoided, will result in death or serious injury.  |
|  | WARNING Indicates a potentially hazardous situation which, if not avoided, could result in death or serious injury.  |
|  | CAUTION Indicates an potentially hazardous situation which, if not avoided, may result in minor or moderate injury.  |
|  | CAUTION used without the safety alert symbol indicates a potentially hazardous situation which, if not avoided, will result in property damage.                                    |

#### IMPORTANT NOTICE

In conjunction with FMVSS (Federal Motor Vehicle Safety Standards) and OEM (Original Equipment Manufacturer) guidelines, Meyer Products has designed this plow package with the following guidelines:

|   |   |
|---|---|
|  | Installation of a snowplow may effect your new vehicle warranty. For more information consult your Vehicle Owner's Manual / Vehicle Dealer.   |
|  | The vehicle must not be operated when overloaded. In all cases, the loaded vehicle weight, including the entire snowplow system, all aftermarket accessories, driver, passenger, options, nominal fluid levels, and cargo must not exceed the front/rear Gross Axle Weight Rating (GAWR), and total Gross Vehicle Weight Rating (GVWR). These weights ratings are specified on the safety compliance certification label on the driver's side door opening. The use of rear ballast weight may be required to prevent exceeding the front GAWR. |

According to the NHTSA (National Highway Traffic Safety Administration) new and untitled vehicles need to be verified by the installer that snowplow and ballast (if needed) do no exceed the front/rear GAWR and total GVWR.

|   |  |
|---|--|
|  |  Read the Meyer Owner's Manual before operating or servicing a snowplow. <b>FOLLOW THESE INSTRUCTIONS EXPLICITLY.</b> |
|---|--|

#### GENERAL INFORMATION

|   |   |
|---|---|
|  | <b>SAFETY PRECAUTIONS</b> should be used when <b>Hydraulic Unit is in OPERATION</b> and plow is in a <b>RAISED</b> position. <b>Lower plow to ground when vehicle is PARKED in case of hydraulic failure.</b> |
|---|---|

Check contents against the parts list to determine all are correct and included, and also to familiarize yourself with them.

|   |  |
|---|--|
|  | Warranty does not apply to a Meyer or Diamond product which has been negligently or improperly assembled or installed. |
|---|--|

|   |   |
|---|---|
|  | <b>CAUTION: To avoid harm to vehicles electrical system always</b> disconnect battery before beginning installation. <b>DO NOT BURN</b> holes or <b>WELD</b> vehicle frame. This may cause frame failure. |
|---|---|

**OVERHAUL and SERVICE INFORMATION** are covered on separate instructions.

Meyer Products and Diamond Equipment reserves the right, under its continuing product improvement program, to change construction or design details, specifications and prices without notice or without incurring any obligation.

|  |
|--|
| Meyer Products LLC<br>18513 Euclid Ave. • Cleveland, Ohio 44112-1084<br>Phone (216) 486-1313<br>www.meyerproducts.com • email info@meyerproducts.com |
|--|

## PARTS LIST

| ITEM | PART NO.      | QTY. | DESCRIPTION                   |
|------|---------------|------|-------------------------------|
|      | 18515         | 1    | <b>MOUNTING CARTON</b>        |
| 1    | 10033         | 1    | • RH Mounting Bracket         |
| 2    | 10032         | 1    | • LH Mounting Bracket         |
| 3    | 10028         | 2    | • Mounting Plate              |
| 4    | 10015         | 1    | • Spacer Weld                 |
| 5    | 10018         | 1    | • Spacer                      |
| 6    | 10020         | 1    | • Clevis Weld                 |
| 7    | 10031         | 2    | • Mounting Shim               |
|      | 08281         | 1    | • <b>HARDWARE BAG</b>         |
| 8    | 20095         | 8    | •• Bolt 1/2-13 x 1-1/2" Gr. 5 |
| 9    | 20105         | 4    | •• Bolt 1/2-13 x 4" Gr. 5     |
| 10   | 20307         | 8    | •• Locknut Esna 1/2-13        |
| 11   | 20329         | 4    | •• Lock washer 1/2"           |
|      | <b>P.A.F.</b> |      | <b>MEYER</b>                  |
|      | PART NO.      | QTY. | DESCRIPTION                   |
|      | 16600         | 1    | <b>Pivot A-Frame Carton</b>   |

Parts indented are included in the carton, bag or assembly under which they are indented.

## IMPORTANT

After first use, retighten all mounting bolt connections to specified torque. All mounting bolt connections to be checked periodically for tightness.

Locknuts are furnished **DO NOT** tighten bolts and nuts until installation is complete (unless otherwise specified), then be sure to tighten all attaching parts per specified torque chart.

## TORQUE CHART FOOT

| Bolt Nut Size | Gr. 2   | Gr. 5     | Gr. 8     |
|---------------|---------|-----------|-----------|
| 1/4 - 20      | 4 - 5   |           |           |
| 5/16 - 18     | 9 - 11  |           |           |
| 3/8 - 16      | 17 - 20 | 26 - 29   |           |
| 7/16 - 14     |         | 42 - 46   | 60 - 66   |
| 1/2 - 13      |         | 64 - 72   | 90 - 100  |
| 5/8 - 11      |         | 127 - 141 | 179 - 198 |

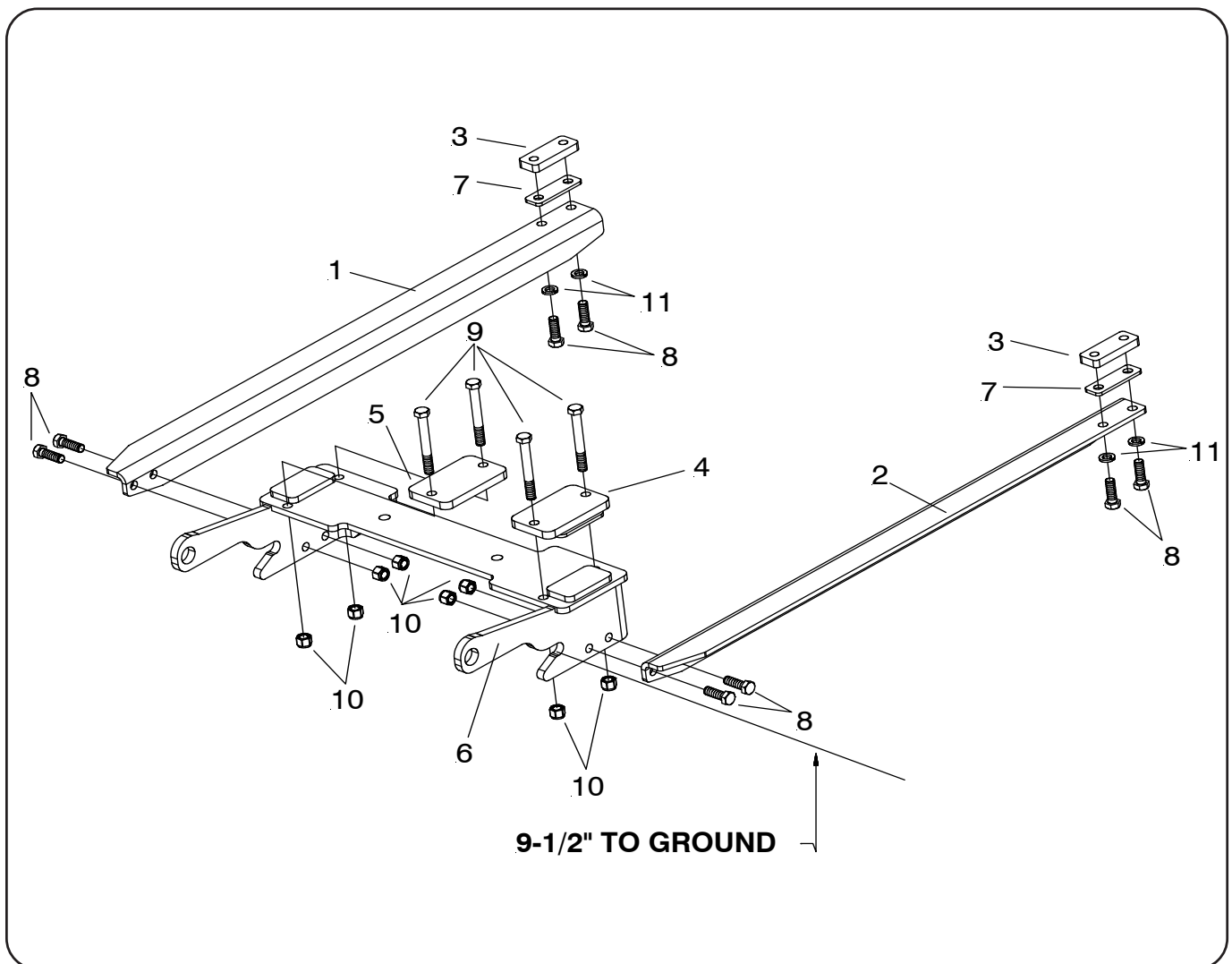

## VEHICLE RECOMMENDATIONS

**WARNING**

- Due to weight restrictions on these vehicle's front GAWR, a Drive Pro 6' 8" moldboard is the largest that can safely be installed on a VW T5. Also limit to driver and one passenger only while plow is installed unless specified below.

**WARNING**

- Ballast weight is not required on the VW T5
- Front end wheel alignment and headlight aim may require readjustment after installation of equipment, and is the responsibility of the equipment installer. Failure to adjust front wheel alignment may cause premature uneven tire wear. If required, reset to chassis manufacture's specifications found in the VW Shop Manual.

Rear ballast is determined by weighing a vehicle's front and rear axles and adding weight behind the rear axle until front axle weight is under or equal to the vehicle specific front GAWR while not exceeding the rear GAWR and GVWR.

Vehicle option packages may vary. If in doubt, it is always a good idea to weigh the vehicle to ensure all weight ratings are not exceeded with plow in the raised position.

## INSTALLATION INSTRUCTIONS

- A. If equipped, remove vehicle air dam and lower bumper valance from front of vehicle frame, save to reinstall at a later time when mounting is removed.
- B. Position Clevis Weld (6) below crossmember of vehicle frame and Spacer Weld (4) and Spacer (5) above crossmember and fasten using 1/2-13 x 4" Bolt (9) and 1/2-13 Locknut (10).
- C. Loosley attach LH & RH Mounting brackets (1 & 2) to Clevis Weld (6) using 1/2-13 x 1-1/2 Bolt (8) and 1/2-13 Locknut (10). Hold Mounting Brackets (1 & 2) to bottom of frame and scribe holes. Drill scribed holes on vehicle frame to 9/16" and attach LH & RH Mounting brackets (1 & 2) to vehicle frame using 1/2-13 x 1-1/2 Bolt (8), Mounting Shim (7) and Mounting Plate (3).
- D. NOTE: before tightening the fasteners, the Drive Pro Clevis (\*) should be level with the ground and pushed back as far under the vehicle as possible.
- E. Tighten all fasteners to their proper torque. Tighten bolts in the same order they were assembled to the vehicle.
- F. Install recommended ballast for this vehicle. Using salt or sand bags are suggested for weight.
- G. Install remaining snowplow hardware per separate instructions.

**WARNING**

**Be sure that load is secure while transporting. With ballast weight in place, be sure that only the driver is in vehicle while plowing to avoid overloading.**

**Meyer Products or Diamond Equipment assumes no responsibility for installations not made in accordance with these instructions.**