

PARTS & INSTALLATION INSTRUCTIONS





DRIVE PRO™

SNOW PLOW MOUNTING CARTON 18523

2006-2012 IVECO DAILY 4x2 MODELS



End user must be given this instruction sheet prior to delievery of this Snow Plow.

SAFETY DEFINITIONS



	This is the safety alert symbol. It is used to alert you to potential personal injury hazards. Obey all safety messages that follow this symbol to avoid possible injury or death.
	DANGER Indicates an imminently hazardous situation which, if not avoided, will result in death or serious injury.
	WARNING Indicates a potentially hazardous situation which, if not avoided, could result in death or serious injury.
	CAUTION Indicates an potentially hazardous situation which, if not avoided, may result in minor or moderate injury.
	CAUTION used without the safety alert symbol indicates a potentially hazardous situation which, if not avoided, will result in property damage.

IMPORTANT NOTICE

In conjunction with FMVSS (Federal Motor Vehicle Safety Standards) and OEM (Original Equipment Manufacturer) guidelines, Meyer Products has designed this plow package with the following guidelines:

	Installation of a snowplow may effect your new vehicle warranty. For more information consult your Vehicle Owner's Manual / Vehicle Dealer.
	The vehicle must not be operated when overloaded. In all cases, the loaded vehicle weight, including the entire snowplow system, all aftermarket accessories, driver, passenger, options, nominal fluid levels, and cargo must not exceed the front/rear Gross Axle Weight Rating (GAWR), and total Gross Vehicle Weight Rating (GVWR). These weights ratings are specified on the safety compliance certification label on the driver's side door opening. The use of rear ballast weight may be required to prevent exceeding the front GAWR.



According to the NHTSA (National Highway Traffic Safety Administration) new and untitled vehicles need to be verified by the installer that snowplow and ballast (if needed) do no exceed the front/rear GAWR and total GVWR.

	 Read the Meyer Owner's Manual before operating or servicing a snowplow. FOLLOW THESE INSTRUCTIONS EXPLICITLY.
---	--

GENERAL INFORMATION

	SAFETY PRECAUTIONS should be used when Hydraulic Unit is in OPERATION and plow is in a RAISED position. Lower plow to ground when vehicle is PARKED in case of hydraulic failure.
---	---

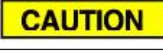
Check contents against the parts list to determine all are correct and included, and also to familiarize yourself with them.

	Warranty does not apply to a Meyer or Diamond product which has been negligently or improperly assembled or installed.
	CAUTION: To avoid harm to vehicles electrical system always disconnect battery before beginning installation. DO NOT BURN holes or WELD vehicle frame. This may cause frame failure.

OVERHAUL and SERVICE INFORMATION are covered on separate instructions.

Meyer Products reserves the right, under its continuing product improvement program, to change construction or design details, specifications and prices without notice or without incurring any obligation.



Meyer Products LLC
18513 Euclid Ave. • Cleveland, Ohio 44112-1084
Phone (216) 486-1313
www.meyerproducts.com • email info@meyerproducts.com

PARTS LIST

ITEM	PART NO.	QTY.	DESCRIPTION
	18523		MOUNTING CARTON
1	10231	1	• LH Side Member
2	10230	1	• RH Side Member
3	10232	2	• Side Brace
4	10233	1	• Rear Brace
	08377	1	• HARDWARE BAG
5	20017	8	• Bolt H 10-1.50P x 40mm Gr. 8.8
6	20018	8	• Bolt H 12-1.50P x 50mm Gr. 8.8
7	22741	2	• Bolt H 12-1.50P x 40mm Gr. 8.8
8	20336	8	• Nut 10-1.50P
9	20330	10	• Nut 12-1.50P
10	20337	8	• Spring Washer 10mm
11	20334	10	• Spring Washer 12mm
12	20349	16	• Flatwasher 10mm
13	20350	16	• Flatwasher 12mm
*	19836	1	Universal Clevis (Part of DP CLF carton)

Parts indented are included in the carton, bag or assembly under which they are indented.

IMPORTANT

After first use, retighten all mounting bolt connections to specified torque. All mounting bolt connections to be checked periodically for tightness.

Locknuts are furnished **DO NOT** tighten bolts and nuts until installation is complete (unless otherwise specified), then be sure to tighten all attaching parts per specified torque chart.

TORQUE CHART FOOT

Bolt Nut Size	Gr. 2	Gr. 5	Gr. 8
1/4 - 20	4 - 5		
5/16 - 18	9 - 11		
3/8 - 16	17 - 20	26 - 29	
7/16 - 14		42 - 46	60 - 66
1/2 - 13		64 - 72	90 - 100
5/8 - 11		127 - 141	179 - 198

NOTE:

THIS MOUNTING CARTON CAN BE USED WITH THE DRIVE PRO MOUNT CLF CARTONS.

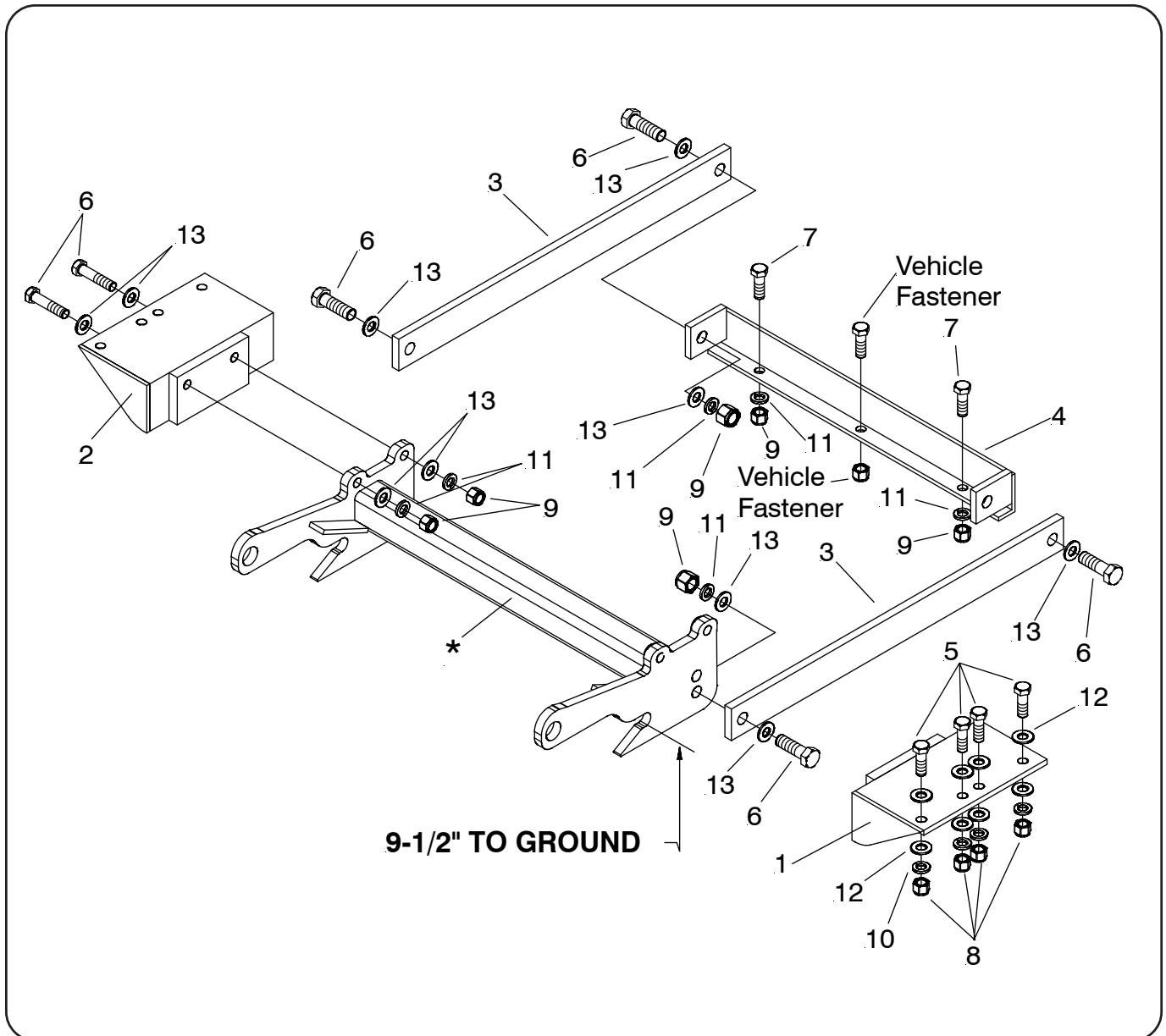

VEHICLE RECOMMENDATIONS

⚠WARNING

- Due to weight restrictions on vehicle's front GAWR, a DP/DPP 7.5 Moldboards only are recommended on vehicles.

⚠WARNING

- A ballast weight may be required to prevent front GAWR overloading. If required, ballast must be securely attached at least 24 inches behind the rear axle.

⚠WARNING

- Front end wheel alignment and headlight aim may require readjustment after installation of equipment, and is the responsibility of the equipment installer. Failure to adjust front wheel alignment may cause premature uneven tire wear. If required, reset to chassis manufacture's specifications found in the Iveco Shop Manual.

Rear ballast is determined by weighing a vehicle's front and rear axles and adding weight behind the rear axle until front axle weight is under or equal to the vehicle specific front GAWR while not exceeding the rear GAWR and GVWR.

Vehicle option packages may vary. If in doubt, it is always a good idea to weigh the vehicle to ensure all weight ratings are not exceeded with plow in the raised position.

INSTALLATION INSTRUCTIONS

- A. Remove bumper, Remove sump guard if fitted.
- B. Attach LH & RH Side Members (1 & 2) using Bolts H 10-1.50P x 40mm (5), 10mm Spring Washer (10), 10mm Flatwashers (12) and Nut 10-1.50P (8).
- C. Attach Clevis (*) to LH & RH Side Members (1 & 2) using Bolts H 12-1.50P x 50mm (6), 12mm Spring Washer (11), 12mm Flatwashers (13) and Nut 12-1.50P (9).
- D. Remove three vehicle fasteners along front lip of crossmember and attach Rear Brace (4) to crossmember using Bolts H 12-1.50P x 40mm (7), 12mm Spring Washer (11) and Nut 12-1.50P (9) in the two end holes. Use existing vehicle fasteners in the middle hole.
- E. Attach Side Brace (3) to LH & RH Side Members (1 & 2) and Rear Brace (4) using Bolts H 12-1.50P x 50mm (6), 12mm Spring Washer (11), 12mm Flatwashers (13) and Nut 12-1.50P (9).

Note: before tightening the fasteners, the clevis (*) should be level with the ground and pushed back as far under the vehicle as possible.

- F. Tighten all fasteners to their proper torque. Tighten bolts in the same order they were assembled.
- G. Trim bumper as shown below and re-attach. Sump guard may also be trimmed and re-attached.



- H. Install remaining snowplow hardware per separate instructions.

Note: when tightening Light Brackets to Lift Frame, you should pull them forward as far as possible, to avoid interference with Iveco hood.

Meyer Products LLC assumes no responsibility for installations not made in accordance with these instructions.