

31553-1

MOUNT KIT PERSONAL PLOW

GM K1500 Silverado/Sierra	2007–18
GM Tahoe/Yukon	2007–__
GM 1500 Suburban/Yukon XL	2007–__
All New	2014–18

Installation Instructions

▲ CAUTION

Read this document before installing the snowplow.

▲ CAUTION

See your sales outlet/website for specific vehicle application recommendations before installation. The online selection system has specific vehicle and snowplow requirements.

SAFETY DEFINITIONS

⚠ WARNING
 Indicates a potentially hazardous situation that, if not avoided, could result in death or serious personal injury.

⚠ CAUTION
 Indicates a potentially hazardous situation that, if not avoided, may result in minor or moderate injury. It may also be used to alert against unsafe practices.

NOTE: Indicates a situation or action that can lead to damage to your snowplow and vehicle or other property. Other useful information can also be described.

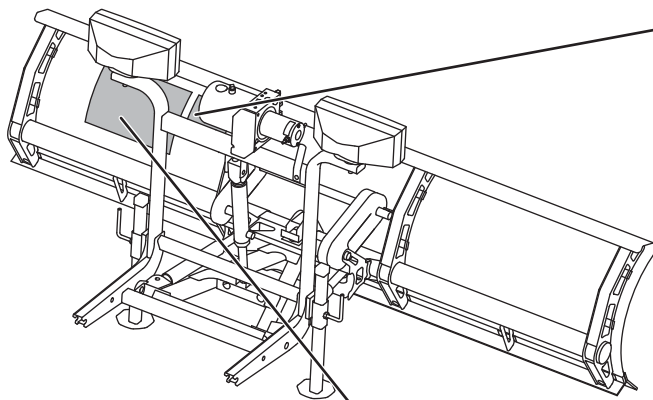

WARNING/CAUTION & INSTRUCTION LABELS

Become familiar with and inform users about the warning/caution and instruction labels on the back of the blade.

NOTE: If labels are missing or cannot be read, see your sales outlet.

Warning/Caution Label

⚠ WARNING	
	Lower blade when vehicle is parked.
	Do not exceed GVWR or GAWR including blade and ballast.
⚠ CAUTION	
	Read Owner's Manual before operating or servicing snowplow.
	Transport speed should not exceed 45 mph (72 km/h). Further reduce speed under adverse travel conditions.
	Plowing speed should not exceed 10 mph (16 km/h).
	See your sales outlet/website for specific vehicle application recommendations.

Instruction Label

This snowplow is for personal/homeowner use only.

ATTACH INSTRUCTIONS	<ol style="list-style-type: none"> 1. Make certain both connecting pins are fully retracted. 2. Drive vehicle slowly to completely insert attachment arms into receiver assembly slots. 3. Twist both connecting pins to release spring tension, then push plow gear toward vehicle so connecting pins fully engage holes in attachment arms. 4. Loosen one jack handle and slide jack sleeve down below jack retainer. Remove jack and retighten jack handle. Repeat for other jack and store them. 5. Connect all electrical cables from vehicle to snowplow. 	
	<small>U.S. patents 6,941,685; 7,400,058; 7,737,576; and other patents pending.</small>	
DETACH INSTRUCTIONS	<ol style="list-style-type: none"> 5. Back vehicle away from snowplow. 6. See Owner's Manual for proper snowplow storage. 3. While pushing plow gear toward vehicle to release connecting pin tension, pull connecting pin out on one side and twist pin handle to keep pin retracted. Repeat procedure for other connecting pin. 4. Disconnect all electrical cables. 	<ol style="list-style-type: none"> 1. Put blade on ground using LOWER/FLOAT on snowplow control. Leave control ON and in FLOAT. 2. Attach jacks. Loosen jack handle, put jack on ground, and raise jack sleeve until fully engaging jack retainer. Tighten jack handle. Repeat for other jack.

Read Owner's Manual for complete instructions.

SAFETY PRECAUTIONS

Improper installation and operation could cause personal injury and/or equipment and property damage. Read and understand labels and the Owner's Manual before installing, operating, or making adjustments.

⚠ WARNING

Lower blade when vehicle is parked. Temperature changes could change hydraulic pressure, causing the blade to drop unexpectedly or damaging hydraulic components. Failure to do this could result in serious personal injury.

⚠ WARNING

The driver shall keep bystanders clear of the blade when it is being raised, lowered, or angled. Do not stand between the vehicle and the blade or within 8 feet of a moving blade. A moving or falling blade could cause personal injury.

⚠ WARNING

Keep hands and feet clear of the blade and A-frame when mounting or removing the snowplow. Moving or falling assemblies could cause personal injury.

⚠ WARNING

Do not exceed GVWR or GAWR including the blade and ballast. The rating label is found on the driver-side vehicle door cornerpost.

⚠ WARNING

To prevent accidental movement of the blade, always turn the control OFF whenever the snowplow is not in use. The power indicator light will turn OFF.

⚠ WARNING

Remove blade assembly before placing vehicle on hoist.

⚠ CAUTION

Refer to the online selection system for minimum vehicle recommendations and ballast requirements.

PERSONAL SAFETY

- Remove the ignition key and put the vehicle in PARK or in gear to prevent others from starting the vehicle during installation or service.
- Wear only snug-fitting clothing while working on your vehicle or snowplow.
- Do not wear jewelry or a necktie, and secure long hair.
- Wear safety goggles to protect your eyes from battery acid, gasoline, dirt, and dust.
- Avoid touching hot surfaces such as the engine, radiator, hoses, and exhaust pipes.
- Always have a fire extinguisher rated BC handy, for flammable liquids and electrical fires.

FIRE AND EXPLOSION

⚠ WARNING

Gasoline is highly flammable and gasoline vapor is explosive. Never smoke while working on vehicle. Keep all open flames away from gasoline tank and lines. Wipe up any spilled gasoline immediately.

Be careful when using gasoline. Do not use gasoline to clean parts. Store only in approved containers away from sources of heat or flame.

CELL PHONES

A driver's first responsibility is the safe operation of the vehicle. The most important thing you can do to prevent a crash is to avoid distractions and pay attention to the road. Wait until it is safe to operate Mobile Communication Equipment such as cell phones, text messaging devices, pagers, or two-way radios.

VENTILATION

⚠ WARNING

Vehicle exhaust contains lethal fumes. Breathing these fumes, even in low concentrations, can cause death. Never operate a vehicle in an enclosed area without venting exhaust to the outside.

NOISE

Airborne noise emission during use is below 70 dB(A) for the snowplow operator.





VIBRATION





Operating snowplow vibration does not exceed 2.5 m/s² to the hand-arm or 0.5 m/s² to the whole body.

TORQUE CHART

⚠ CAUTION

Read instructions before assembling. Fasteners should be finger tight until instructed to tighten according to the torque chart. Use standard methods and practices when attaching snowplow including proper personal protective safety equipment.

Recommended Fastener Torque Chart					
Inch Fasteners Grade 5 and Grade 8					
Size	Torque (ft-lb)		Size	Torque (ft-lb)	
	 Grade 5	 Grade 8		 Grade 5	 Grade 8
1/4-20	8.4	11.9	9/16-12	109	154
1/4-28	9.7	13.7	9/16-18	121	171
5/16-18	17.4	24.6	5/8-11	150	212
5/16-24	19.2	27.3	5/8-18	170	240
3/8-16	30.8	43.6	3/4-10	269	376
3/8-24	35.0	49.4	3/4-16	297	420
7/16-14	49.4	69.8	7/8-9	429	606
7/16-20	55.2	77.9	7/8-14	474	669
1/2-13	75.3	106.4	1-8	644	909
1/2-20	85.0	120.0	1-12	704	995

Metric Fasteners Class 8.8 and 10.9					
Size	Torque (ft-lb)		Size	Torque (ft-lb)	
	 Class 8.8	 Class 10.9		 Class 8.8	 Class 10.9
M6 x 1.00	7.7	11.1	M20 x 2.50	325	450
M8 x 1.25	19.5	26.9	M22 x 2.50	428	613
M10 x 1.50	38.5	53.3	M24 x 3.00	562	778
M12 x 1.75	67	93	M27 x 3.00	796	1139
M14 x 2.00	107	148	M30 x 3.50	1117	1545
M16 x 2.00	167	231	M33 x 3.50	1468	2101
M18 x 2.50	222	318	M36 x 4.00	1952	2701

These torque values apply to fasteners except those noted in the instructions.

INSTALLATION INSTRUCTIONS

NOTE: For easier assembly and installation, the vehicle and all snowplow components should be on a smooth, level, hard surface, such as concrete.

Bumper Removal Instructions

For 2013 and older truck models only:

1. Remove the bumper. Retain the fasteners.
2. Remove the splash shield. Retain the fasteners.
3. Continue to Mount Installation Instructions on page 7.

For 2014 and newer truck models only:

1. Remove the plastic top cover (shown below) from the front of the engine compartment.

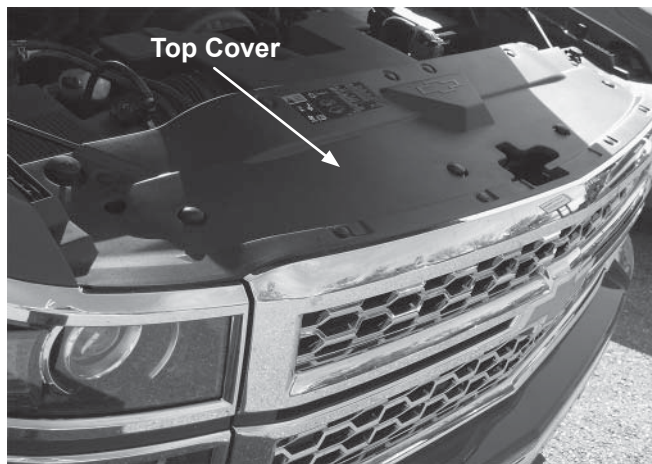

2. Remove the four cap screws and release the locking tabs located along the top of the grille.

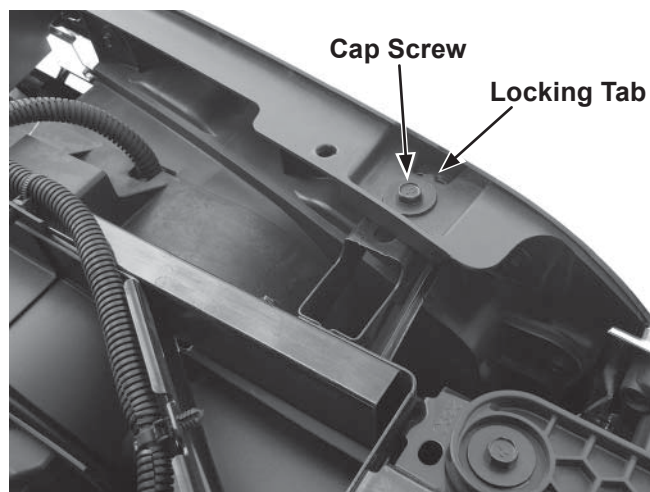

3. Remove the four screws attaching the grille to the radiator support.

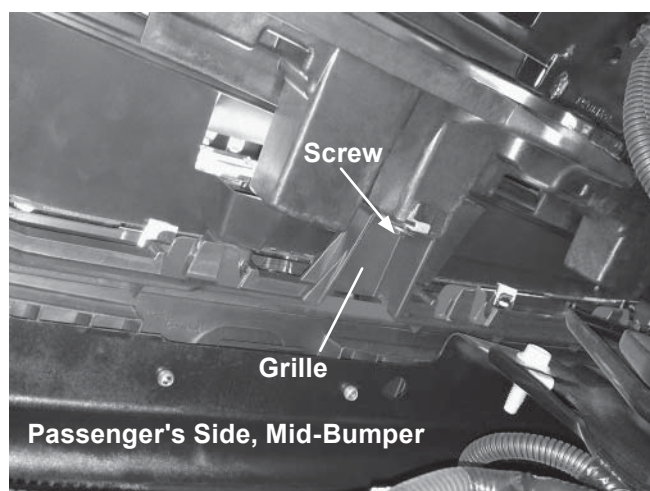
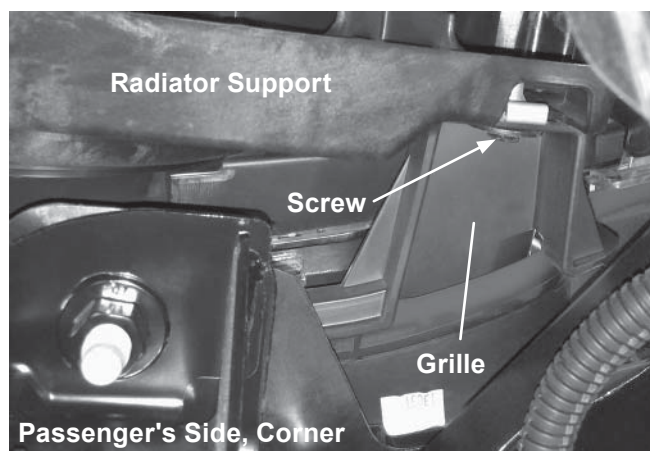

4. Remove the two bumper cover screws located on the inside of each front wheel well. If the vehicle is equipped with fender trim, the trim will need to be displaced in order to access the screws.



6. Pull the bumper cover assembly forward to disengage the grille tabs and remove the grille.
7. Remove the four main bumper fasteners and the single fastener securing the bumper ends to the outer bumper supports. Remove the bumper.

5. Release the hidden locking tabs on each side of the vehicle and pull the bumper cover outward.



Mount Installation Instructions

1. On the passenger's side of the vehicle, remove the front tow hook locknut. Align the front hole in the passenger-side mount with the front tow hook cap screw, then reinstall the tow hook locknut to attach the mount plate to the truck frame.



2. Rotate the passenger-side mount back, and push it tight up against the bottom of the frame. Clamp the mount plate in place against the frame.

⚠ CAUTION

Use caution not to pinch, cut, or drill through any wires or hoses running along the frame rails.

3. Using the holes in the passenger-side mount as guides, drill three 17/32" holes into the frame.

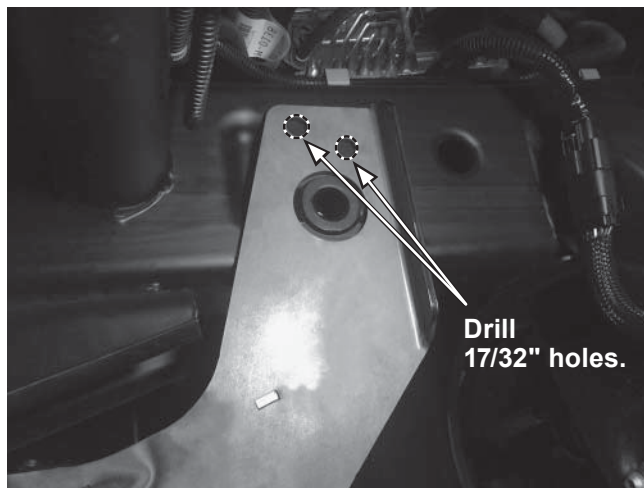

4. Place a 1/2" flat washer on each of two 1/2" x 1-1/2" cap screws with handles. Insert the two cap screws with handles and flat washers into the inside of the truck frame and out through the rear drilled holes. Attach a 1/2" locknut to each cap screw, and hand tighten.
5. Completely remove the passenger-side tow hook. Retain the fasteners.

6. Insert one 1/2" x 1-1/4" cap screw or 1/2" x 1-1/2" cap screw with handle and 1/2" flat washer into the front of the truck frame and out through the rear hole in the front arm of the mount plate. Attach a 1/2" locknut, and hand tighten.
7. Reinstall the passenger-side tow hook using the original fasteners. Remove the clamp from the mount plate.
8. On the driver's side of the vehicle, completely remove the tow hook. Retain fasteners.
9. Align the front holes in the driver-side mount with the tow hook holes in the truck frame. Reinstall the tow hook fasteners, attaching both the tow hook and the driver-side mount plate to the truck frame.
10. Make sure that the driver-side mount is tight up against the bottom of the frame. Clamp the mount plate in place against the frame if necessary.

⚠ CAUTION

Use caution not to pinch, cut, or drill through any wires or hoses running along the frame rails.

11. Using the holes in the driver-side mount as guides, drill two 17/32" holes into the frame.
12. Place a 1/2" flat washer on each of two 1/2" x 1-1/4" cap screws with handles. Insert the two cap screws with handles and flat washers into the inside of the truck frame and out through the rear drilled holes. Attach a 1/2" locknut to each cap screw, and hand tighten. Bend or trim the handles after installation to avoid interference with vehicle components. Remove the clamp from the mount plate, if applicable.
13. Align the four holes on each side of the pushbeam with the holes in the mounts. Choose the set of holes that will bring the pushbeam closest to the dimension shown in the illustration to the right.
14. Attach the pushbeam to the mounts using eight 1/2" x 1-1/4" cap screws (four on each end). Place a 1/2" locknut on each cap screw, and fully tighten according to the torque chart.
15. Measure the distance between the pushbeam rear hole and the ground. If it exceeds 11-1/2", install the accessory Height Adapter Plate Kit (PN 77555) to ensure optimum plowing performance.

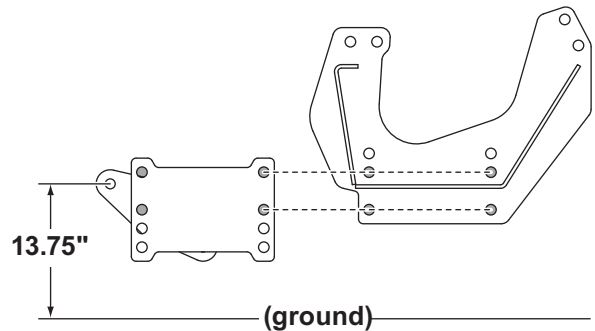
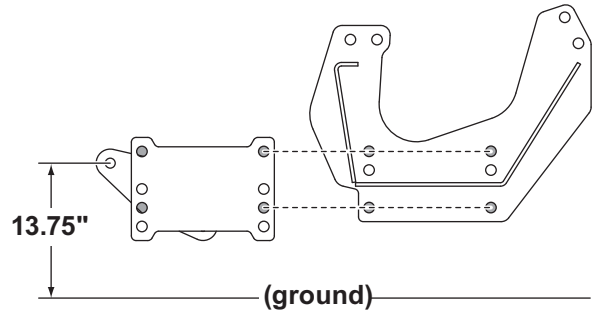
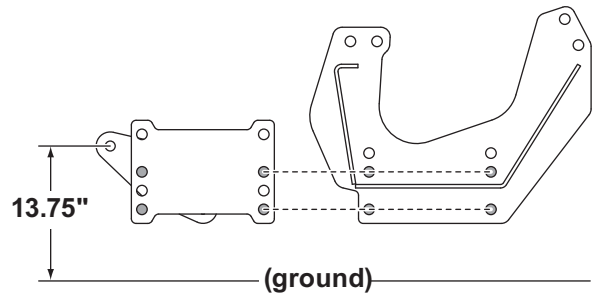

16. Push the mounts tight up against the truck frame, then fully tighten the fasteners securing the mounts and tow hooks to the frame rails according to the torque chart.
17. Reattach the splash shield using the original fasteners.
18. If the air dam does not clear the pushbeam, remove or notch the air dam as needed.
19. Reattach the bumper using the original fasteners.

NOTE: After five to ten hours of snowplow usage, retorque all mount assembly fasteners.

Bumper Notch Instructions

On 2013 and older truck models only:

1. If the lower plastic portion of the bumper does not clear the pushplates, notch it as needed.
2. Reattach the lower plastic portion of the bumper using the original fasteners.

NOTE: After five to ten hours of snowplow usage, retorque all pushplate assembly fasteners.

On 2014 and newer truck models only:

1. Remove the bumper brackets and bumper filler from the main bumper assembly.
2. Depending on your vehicle make, notch each side of the bumper, bumper bracket, and bumper filler according to the cut lines as shown.

All depictions are of driver-side bumper parts, except where noted.

GMC Vehicles:

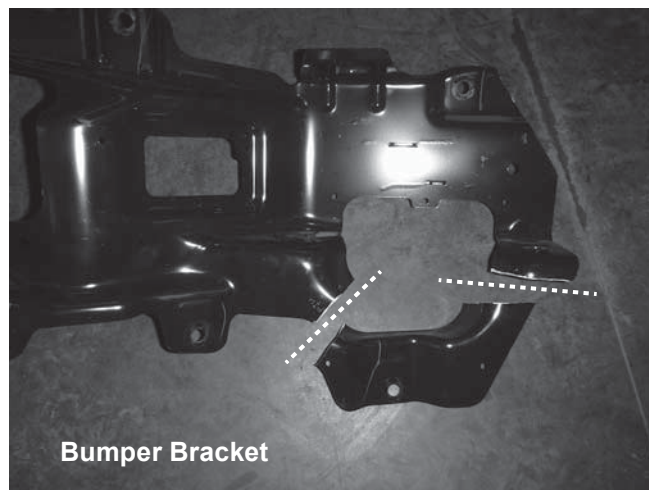
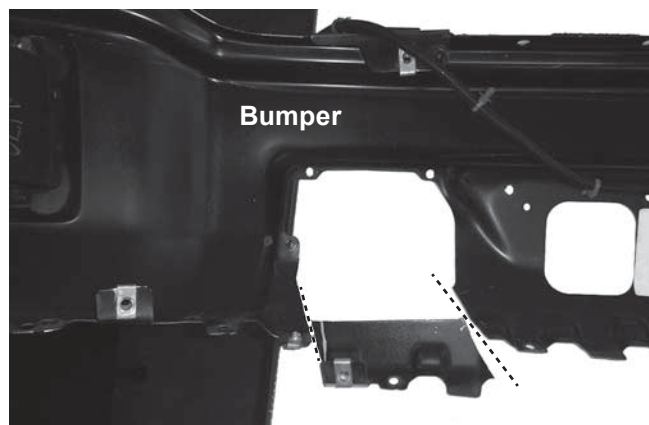

NOTE: Bumper fillers may vary. Begin by cutting small notches in the bumper filler; trim only as needed to fit.

Bumper Filler



Passenger's Side

Chevy Vehicles:

Bumper

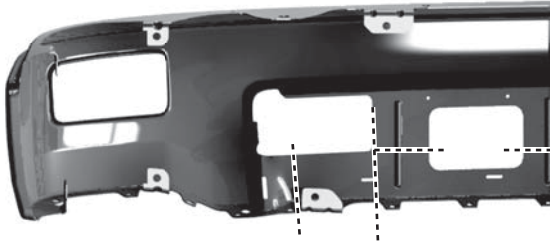

Bumper Bracket

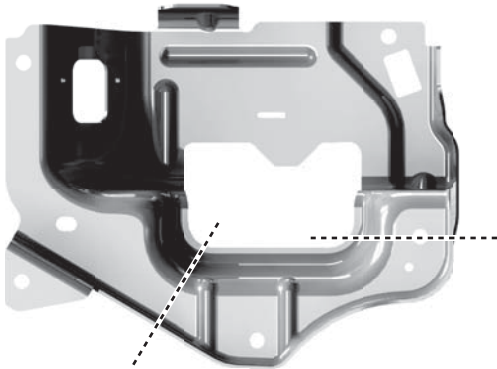

3. Reassemble and reinstall the bumper using the original fasteners.
4. The midsection of the Chevy bumper fillers will need to be either secured rearward or trimmed to clear the snowplow lower gear.

NOTE: After five to ten hours of snowplow usage, retorque all mount assembly fasteners.

NOTE: Bumper fillers may vary. Begin by cutting small notches in the bumper filler; trim only as needed to fit.

Bumper Filler



Passenger's Side

The company reserves the right under its product improvement policy to change construction or design details and furnish equipment when so altered without reference to illustrations or specifications used. This equipment manufacturer or the vehicle manufacturer may require or recommend optional equipment for snow removal. Do not exceed vehicle ratings with a snowplow. The company offers a limited warranty for all snowplows and accessories. See separately printed page for this important information.