

# 33222

## MOUNT KIT

Freightliner M2 106

2019-\_\_

Installation Instructions

**▲ CAUTION**

Read this document before installing the snowplow.

**▲ CAUTION**

See your sales outlet/website for specific vehicle application recommendations before installation. The online selection system has specific vehicle and snowplow requirements.

**SAFETY DEFINITIONS**

**⚠ WARNING**  
 Indicates a potentially hazardous situation that, if not avoided, could result in death or serious personal injury.

**⚠ CAUTION**  
 Indicates a potentially hazardous situation that, if not avoided, may result in minor or moderate injury. It may also be used to alert against unsafe practices.

**NOTE:** Indicates a situation or action that can lead to damage to your snowplow and vehicle or other property. Other useful information can also be described.

**WARNING/CAUTION & INSTRUCTION LABELS**

Become familiar with and inform users about the warning and instruction labels on the back of the blade.

**NOTE:** If labels are missing or cannot be read, see your sales outlet.

Warning/Caution Label

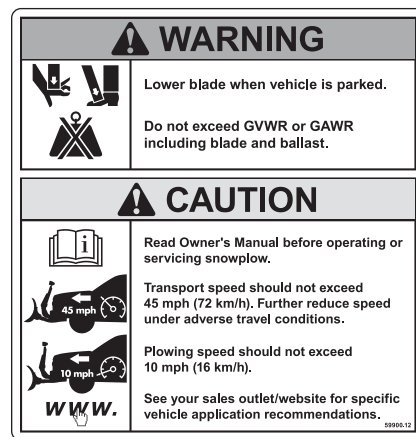

Instruction Label

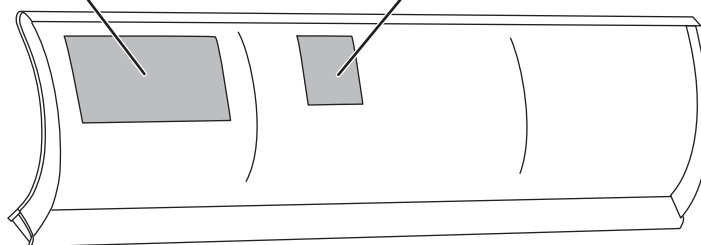

## SAFETY PRECAUTIONS

Improper installation and operation could cause personal injury and/or equipment and property damage. Read and understand labels and the Owner's Manual before installing, operating, or making adjustments.

### **⚠ WARNING**

**Lower the blade when vehicle is parked. Temperature changes could change hydraulic pressure, causing the blade to drop unexpectedly or damaging hydraulic components. Failure to do this could result in serious personal injury.**

### **⚠ WARNING**

**The driver shall keep bystanders clear of the blade when it is being raised, lowered, or angled. Do not stand between vehicle and blade or within 8 feet of a moving blade. A moving or falling blade could cause personal injury.**

### **⚠ WARNING**

**Keep hands and feet clear of the blade and A-frame when mounting or removing the snowplow. Moving or falling assemblies could cause personal injury.**

### **⚠ WARNING**

**Do not exceed GVWR or GAWR including the blade and ballast. The rating label is found on the driver-side vehicle door cornerpost.**

### **⚠ WARNING**

**To prevent accidental movement of the blade, always turn the control OFF whenever the snowplow is not in use. The power indicator light will turn OFF.**

### **⚠ WARNING**

**Remove blade assembly before placing vehicle on hoist.**

### **⚠ CAUTION**

**Refer to the online selection system for minimum vehicle recommendations and ballast requirements.**

## PERSONAL SAFETY

- Remove the ignition key and put the vehicle in PARK or in gear to prevent others from starting the vehicle during installation or service.
- Wear only snug-fitting clothing while working on your vehicle or snowplow.
- Do not wear jewelry or a necktie, and secure long hair.
- Wear safety goggles to protect your eyes from battery acid, gasoline, dirt, and dust.
- Avoid touching hot surfaces such as the engine, radiator, hoses, and exhaust pipes.
- Always have a fire extinguisher rated BC handy, for flammable liquids and electrical fires.

## FIRE AND EXPLOSION

### **⚠ WARNING**

**Gasoline is highly flammable and gasoline vapor is explosive. Never smoke while working on vehicle. Keep all open flames away from gasoline tank and lines. Wipe up any spilled gasoline immediately.**

Be careful when using gasoline. Do not use gasoline to clean parts. Store only in approved containers away from sources of heat or flame.

## CELL PHONES

A driver's first responsibility is the safe operation of the vehicle. The most important thing you can do to prevent a crash is to avoid distractions and pay attention to the road. Wait until it is safe to operate Mobile Communication Equipment such as cell phones, text messaging devices, pagers, or two-way radios.

## VENTILATION

### **⚠ WARNING**

**Vehicle exhaust contains lethal fumes. Breathing these fumes, even in low concentrations, can cause death. Never operate a vehicle in an enclosed area without venting exhaust to the outside.**

**NOISE**

Airborne noise emission during use is below 70 dB(A) for the snowplow operator.





**VIBRATION**

Operating snowplow vibration does not exceed 2.5 m/s<sup>2</sup> to the hand-arm or 0.5 m/s<sup>2</sup> to the whole body.





**TORQUE CHART**

**⚠ CAUTION**

Read instructions before assembling. Fasteners should be finger tight until instructed to tighten according to the torque chart. Use standard methods and practices when attaching snowplow, including proper personal protective safety equipment.

Recommended Fastener Torque Chart					
Inch Fasteners Grade 5 and Grade 8					
Size	Torque (ft-lb)		Size	Torque (ft-lb)	
	 Grade 5	 Grade 8		 Grade 5	 Grade 8
1/4-20	8.4	11.9	9/16-12	109	154
1/4-28	9.7	13.7	9/16-18	121	171
5/16-18	17.4	24.6	5/8-11	150	212
5/16-24	19.2	27.3	5/8-18	170	240
3/8-16	30.8	43.6	3/4-10	269	376
3/8-24	35.0	49.4	3/4-16	297	420
7/16-14	49.4	69.8	7/8-9	429	606
7/16-20	55.2	77.9	7/8-14	474	669
1/2-13	75.3	106.4	1-8	644	909
1/2-20	85.0	120.0	1-12	704	995

Metric Fasteners Class 8.8 and 10.9					
Size	Torque (ft-lb)		Size	Torque (ft-lb)	
	 Class 8.8	 Class 10.9		 Class 8.8	 Class 10.9
M6 x 1.00	7.7	11.1	M20 x 2.50	325	450
M8 x 1.25	19.5	26.9	M22 x 2.50	428	613
M10 x 1.50	38.5	53.3	M24 x 3.00	562	778
M12 x 1.75	67	93	M27 x 3.00	796	1139
M14 x 2.00	107	148	M30 x 3.50	1117	1545
M16 x 2.00	167	231	M33 x 3.50	1468	2101
M18 x 2.50	222	318	M36 x 4.00	1952	2701

These torque values apply to fasteners except those noted in the instructions.

**INSTALLATION INSTRUCTIONS**

**NOTE: For easier assembly and installation, the vehicle and all snowplow components should be on a smooth, level, hard surface, such as concrete.**

1. Remove the bumper to gain access to the tow hook bolts.



2. Remove the tow hooks from the vehicle. Save the tow hooks and fasteners for reinstallation if the mount is removed.

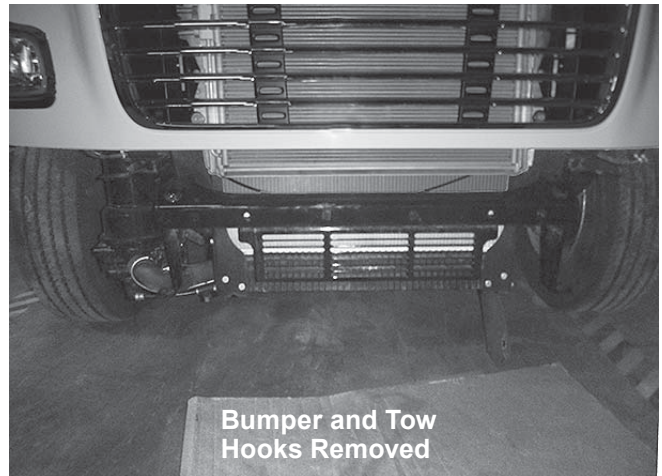

3. Install a 5/8" x 2" cap screw up through the middle tow hook bolt hole on the driver's side. Secure the fastener with a 5/8" washer and 5/8" locknut. Tighten according to the torque chart. Repeat this step on the passenger's side.

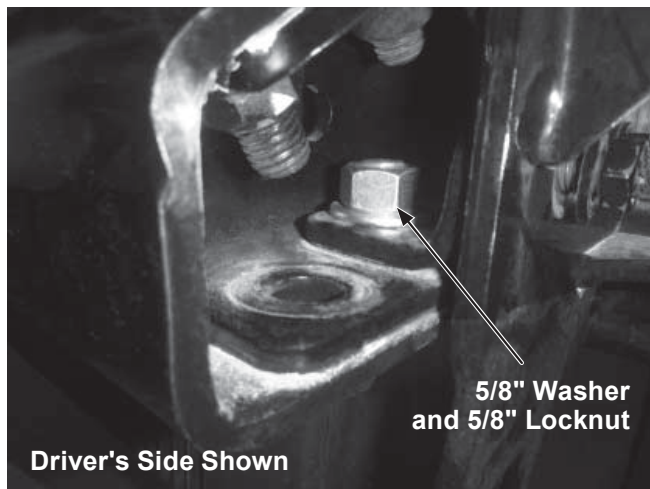

4. Place the driver-side bracket against the bottom of the frame in the space previously occupied by the tow hook. Insert two 5/8" x 2-1/2" cap screws in the front bracket holes and up through the front tow hook bolt holes. Secure each cap screw with a 5/8" washer and 5/8" locknut. Hand tighten the fasteners.

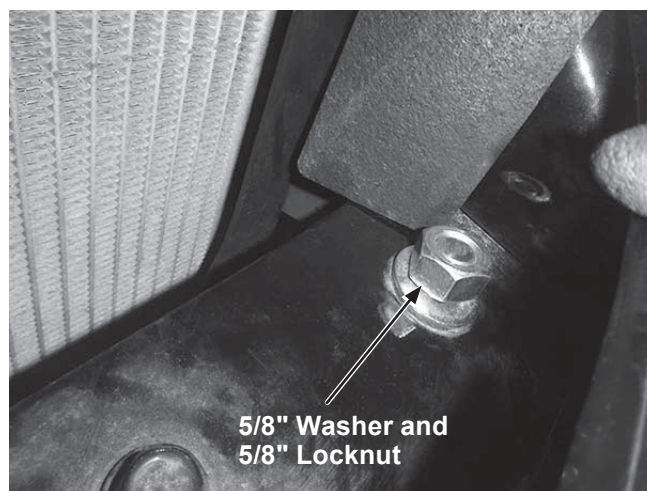

5. Place a 5/8" washer on a 5/8" x 2-1/2" cap screw. Insert the cap screw and washer down through the rear tow hook bolt hole. Secure with a 5/8" locknut. Hand tighten the locknut.

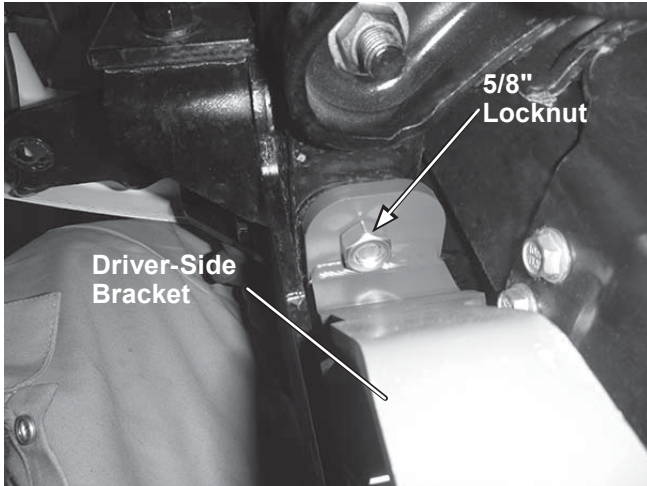

7. Check that the driver-side and passenger-side bracket assemblies are parallel. Tighten, but do not torque the fasteners.

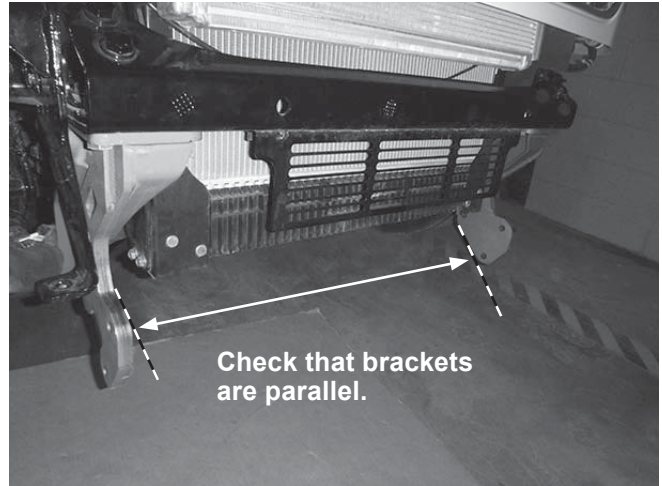

6. Repeat Steps 3–5 on the passenger's side of the vehicle using the passenger-side bracket.

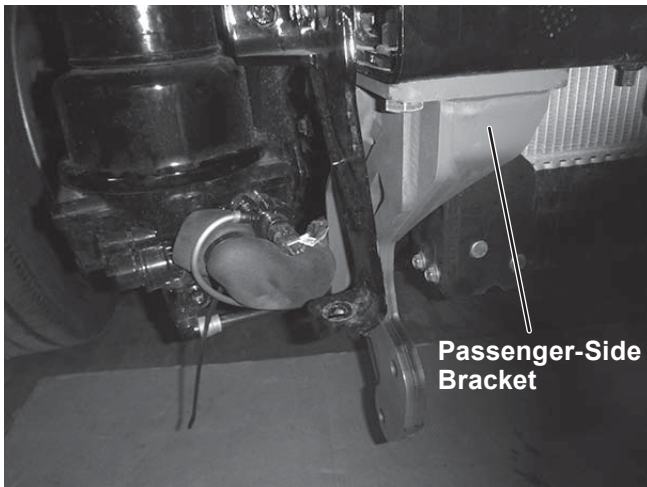

8. Using a floor jack, position the mount between the two bracket assemblies. Raise the mount beam up until the six holes of the mount (three holes on each end of the beam) align with corresponding holes of the brackets.

9. Fasten the mount to the brackets using six 5/8" x 2-1/2" cap screws. Level the mount, then secure the cap screws with 5/8" locknuts. Hand tighten the fasteners.

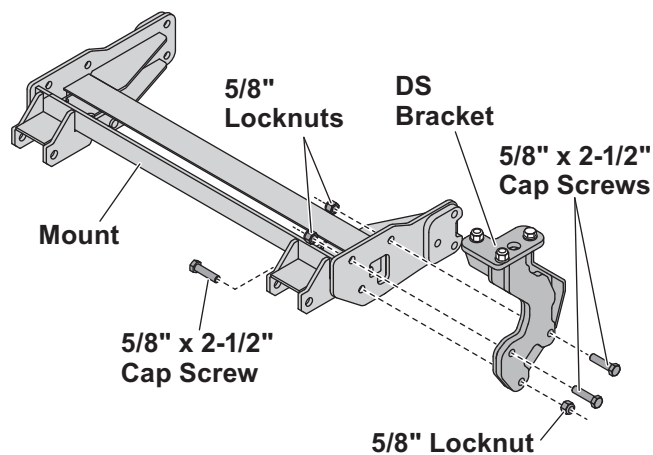

10. Install the driver-side thrust arm to the mount with three 5/8" x 3-1/4" cap screws. Loosely secure the cap screws with 5/8" locknuts.

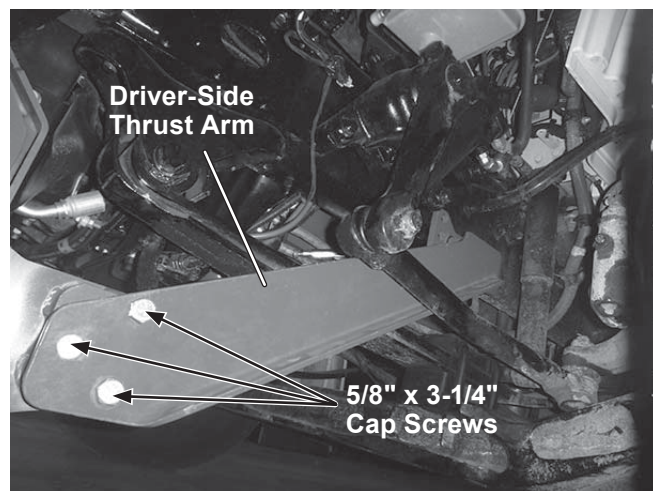

11. Push the rear of the thrust arm up against the frame. Clamp the thrust arm in place, then fully tighten the fasteners installed in Step 10.

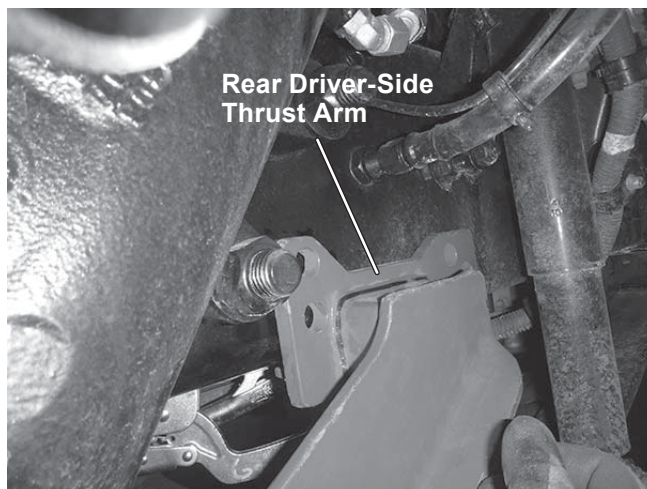

### ⚠ CAUTION

Before drilling any holes, check to be sure that no vehicle wiring or other components could be damaged.

12. Drill three 21/32" holes through the frame using the front top hole and the two rear holes of the thrust arm as a guide. Use caution when drilling to avoid hitting the wiring harness.

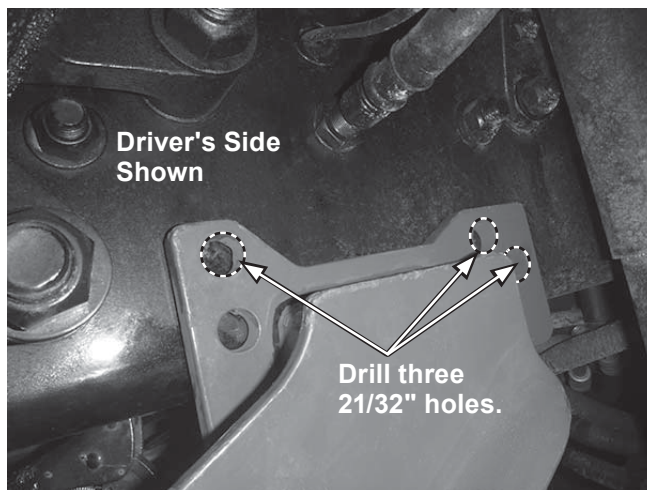

13. Insert three 5/8" x 2" cap screws through the drilled holes. Secure each of the cap screws with a 5/8" washer and 5/8" locknut. Hand tighten the fasteners.

**⚠ CAUTION**

**Before drilling any holes, check to be sure that no vehicle wiring or other components could be damaged.**

14. Repeat Steps 10–13 on the passenger's side of the vehicle. To drill the holes through the frame on the passenger's side, it will be necessary to loosen the lower shock bolt and swing the shock out of the way. Use caution when drilling to avoid hitting the air adjuster on the inside of the frame.
15. Tighten all fasteners according to the torque chart, then reinstall the bumper.

---

**NOTE: After five to ten hours of snowplow usage, retorque all mount assembly fasteners.**

---

The company reserves the right under its product improvement policy to change construction or design details and furnish equipment when so altered without reference to illustrations or specifications used. This equipment manufacturer or the vehicle manufacturer may require or recommend optional equipment for snow removal. Do not exceed vehicle ratings with a snowplow. The company offers a limited warranty for all snowplows and accessories. See separately printed page for this important information.

**Printed in U.S.A.**