

35156

MOUNT KIT

Polaris Ranger 1000

2018-__

Installation Instructions

▲ CAUTION

Read this document before installing the snowplow.

▲ CAUTION

See your sales outlet/website for specific vehicle application recommendations before installation. The online selection system has specific vehicle and snowplow requirements.

SAFETY DEFINITIONS

⚠ WARNING

Indicates a potentially hazardous situation that, if not avoided, could result in death or serious personal injury.

⚠ CAUTION

Indicates a potentially hazardous situation that, if not avoided, may result in minor or moderate injury. It may also be used to alert against unsafe practices.

NOTE: Indicates a situation or action that can lead to damage to your snowplow and vehicle or other property. Other useful information can also be described.







WARNING/CAUTION & INSTRUCTION LABELS

Become familiar with and inform users about the warning/caution and instruction labels on the back of the blade.

NOTE: If labels are missing or cannot be read, see your sales outlet.

Attach/Detach Label

Warning/Caution Label

⚠ WARNING	
	Lower blade when vehicle is parked.
	Do not exceed GVWR or GAWR including blade and ballast.
⚠ CAUTION	
	Read Owner's Manual before operating or servicing snowplow.
	Transport speed should not exceed 20 mph (32 km/h). Further reduce speed under adverse travel conditions.
	Plowing speed should not exceed 10 mph (16 km/h).
	See your sales outlet/website for specific vehicle application recommendations.

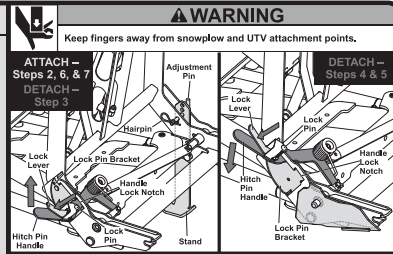
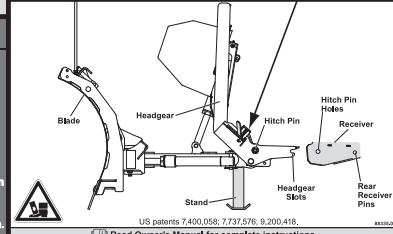
<p>ATTACH</p> <ol style="list-style-type: none"> Slowly drive vehicle forward to engage rear receiver pins into headgear slots. Apply vehicle parking brake. Hold down lock lever and move hitch pin handle out of the handle lock notch, allowing spring to move the hitch pin handle forward. Plug in electrical harness. Turn plow control in vehicle ON and activate FLOAT. Stand in front of blade. Push top of headgear toward vehicle to allow hitch pins to fully engage hitch pin holes. Verify the lock pin is engaged in the forward hole in the lock pin bracket. Remove hairpin, adjustment pin, & stand. 	<p>⚠ WARNING</p> <p>Keep fingers away from snowplow and UTV attachment points.</p> <p>ATTACH – Steps 2, 6, & 7</p> <p>DETACH – Step 3</p> <p>DETACH – Steps 4 & 5</p> 
<p>DETACH</p> <ol style="list-style-type: none"> With blade straight, lower snowplow to the ground. Activate FLOAT, then turn plow control in vehicle OFF. Apply vehicle parking brake. Unplug electrical harness. Insert stand through slot in the passenger side headgear horn. Adjust stand as far down as possible, install adjustment pin, and secure with a hairpin. Hold down lock lever to disengage the lock pin and move the hitch pin handle rearward to fully disengage hitch pins from receivers. Move hitch pin handle into handle lock notch. 	 <p>US patents 7,400,058; 7,737,576; 9,200,418.</p> <p>Read Owner's Manual for complete instructions.</p>

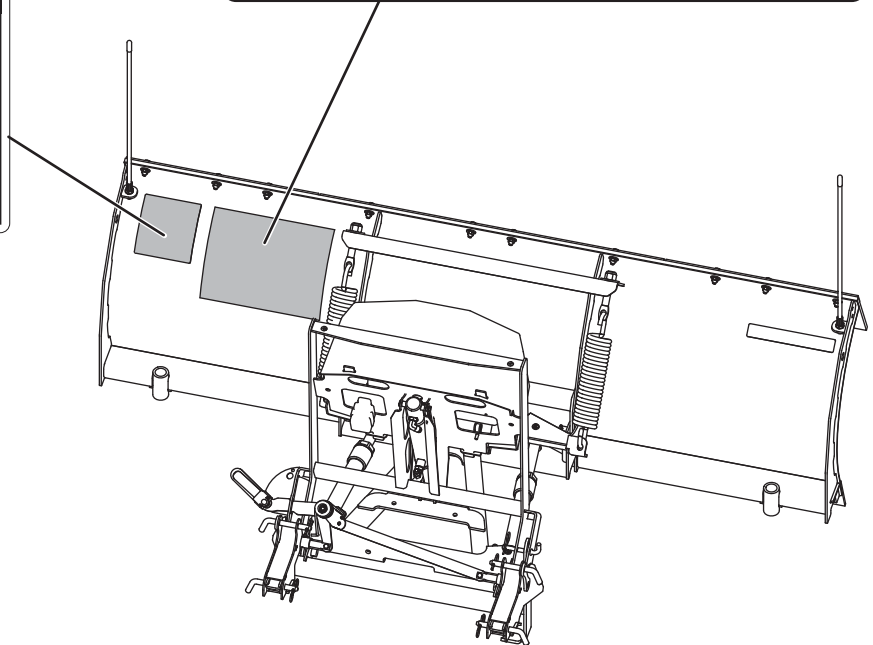

SAFETY PRECAUTIONS

Follow all safety and operating instructions in your UTV Owner's Manual.

Improper installation and operation could cause personal injury, and/or equipment and property damage. Read and understand labels and the Owner's Manual before installing, operating, or making adjustments.

⚠ WARNING

Lower the blade when vehicle is parked. Temperature changes could change hydraulic pressure, causing the blade to drop unexpectedly or damaging hydraulic components. Failure to do this could result in serious personal injury.

⚠ WARNING

The driver shall keep bystanders clear of the blade when it is being raised, lowered, or angled. Do not stand between the vehicle and the blade or within 8 feet of a moving blade. A moving or falling blade could cause personal injury.

⚠ WARNING

Keep hands and feet clear of the blade and A-frame when mounting or removing the snowplow. Moving or falling assemblies could cause personal injury.

⚠ WARNING

Do not exceed GVWR, GAWR, or maximum vehicle load capacity, including the blade and ballast.

⚠ WARNING

To prevent accidental movement of the blade, always turn the control OFF whenever the snowplow is not in use. The power indicator light will turn OFF.

⚠ WARNING

Remove blade assembly before placing vehicle on hoist.

⚠ WARNING

Vehicle mount reduces ground clearance. Use additional caution when driving vehicle with mount installed. Remove vehicle mount to restore original vehicle ground clearance at the end of the plowing season.

⚠ CAUTION

Refer to the online selection system for minimum vehicle recommendations and ballast requirements.

PERSONAL SAFETY

- Remove the ignition key and put the vehicle in PARK or in gear to prevent others from starting the vehicle during installation or service.
- Wear only snug-fitting clothing while working on your vehicle or snowplow.
- Do not wear jewelry or a necktie, and secure long hair.
- Wear safety goggles to protect your eyes from battery acid, gasoline, dirt, and dust.
- Avoid touching hot surfaces such as the engine, radiator, hoses, and exhaust pipes.
- Always have a fire extinguisher rated BC handy, for flammable liquids and electrical fires.

FIRE AND EXPLOSION

⚠ WARNING

Gasoline is highly flammable and gasoline vapor is explosive. Never smoke while working on vehicle. Keep all open flames away from gasoline tank and lines. Wipe up any spilled gasoline immediately.

Be careful when using gasoline. Do not use gasoline to clean parts. Store only in approved containers away from sources of heat or flame.

CELL PHONES

A driver's first responsibility is the safe operation of the vehicle. The most important thing you can do to prevent a crash is to avoid distractions and pay attention to the road. Wait until it is safe to operate Mobile Communication Equipment such as cell phones, text messaging devices, pagers, or two-way radios.

VENTILATION

 WARNING
<p>Vehicle exhaust contains lethal fumes. Breathing these fumes, even in low concentrations, can cause death. Never operate a vehicle in an enclosed area without venting exhaust to the outside.</p>

NOISE









Airborne noise emission during use is below 95 dB(A) for the snowplow operator.

VIBRATION

Operating snowplow vibration does not exceed 2.5 m/s² to the hand-arm or 0.5 m/s² to the whole body.

TORQUE CHART

 CAUTION
<p>Read instructions before assembling. Fasteners should be finger tight until instructed to tighten according to the torque chart. Use standard methods and practices when attaching snowplow, including proper personal protective safety equipment.</p>

Recommended Fastener Torque Chart					
Inch Fasteners Grade 5 and Grade 8					
Size	Torque (ft-lb)		Size	Torque (ft-lb)	
	 Grade 5	 Grade 8		 Grade 5	 Grade 8
1/4-20	8.4	11.9	9/16-12	109	154
1/4-28	9.7	13.7	9/16-18	121	171
5/16-18	17.4	24.6	5/8-11	150	212
5/16-24	19.2	27.3	5/8-18	170	240
3/8-16	30.8	43.6	3/4-10	269	376
3/8-24	35.0	49.4	3/4-16	297	420
7/16-14	49.4	69.8	7/8-9	429	606
7/16-20	55.2	77.9	7/8-14	474	669
1/2-13	75.3	106.4	1-8	644	909
1/2-20	85.0	120.0	1-12	704	995
Metric Fasteners Class 8.8 and 10.9					
Size	Torque (ft-lb)		Size	Torque (ft-lb)	
	 Class 8.8	 Class 10.9		 Class 8.8	 Class 10.9
M6 x 1.00	7.7	11.1	M20 x 2.50	325	450
M8 x 1.25	19.5	26.9	M22 x 2.50	428	613
M10 x 1.50	38.5	53.3	M24 x 3.00	562	778
M12 x 1.75	67	93	M27 x 3.00	796	1139
M14 x 2.00	107	148	M30 x 3.50	1117	1545
M16 x 2.00	167	231	M33 x 3.50	1468	2101
M18 x 2.50	222	318	M36 x 4.00	1952	2701
These torque values apply to fasteners except those noted in the instructions.					

INSTALLATION INSTRUCTIONS

NOTE: For easier assembly and installation, the vehicle and all snowplow components should be on a smooth, level, hard surface, such as concrete.

1. Remove the two M10 cap screws and nuts that secure the bottom of the brush guard to the frame.



2. Place the skid plate assembly against the bottom of the vehicle frame. Line up the six slots on the bottom of the skid plate assembly with the six corresponding holes on the vehicle. Clamp the skid plate assembly in place.

3. Place a 3/8" washer on a 3/8" x 1-3/4" cap screw. On the driver's side, install the cap screw through the bottom front hole of the skid plate assembly and vehicle. Secure with a 3/8" washer and 3/8" locknut. Hand tighten the fasteners.

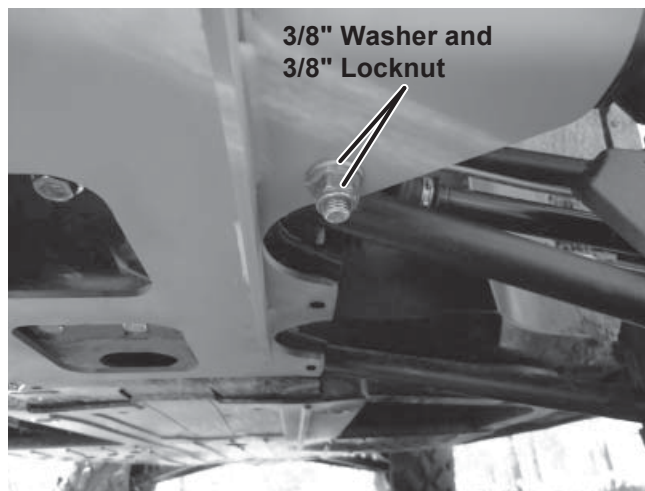

4. Place a 3/8" washer on each of two 3/8" x 1-3/4" cap screws. Install the cap screws through the remaining bottom holes. Secure with 3/8" washers and 3/8" locknuts. Hand tighten the fasteners.

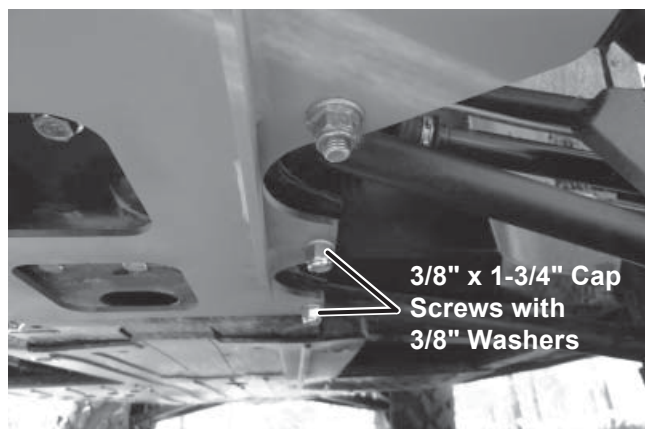

5. Repeat Steps 3 and 4 on the passenger's side of the vehicle.

- Place a washer on each of the four 1/2" x 1-1/4" cap screws. Install the cap screws through the four slots in the front of the skid plate. Secure each fastener with a backer plate and 1/2" locknut.

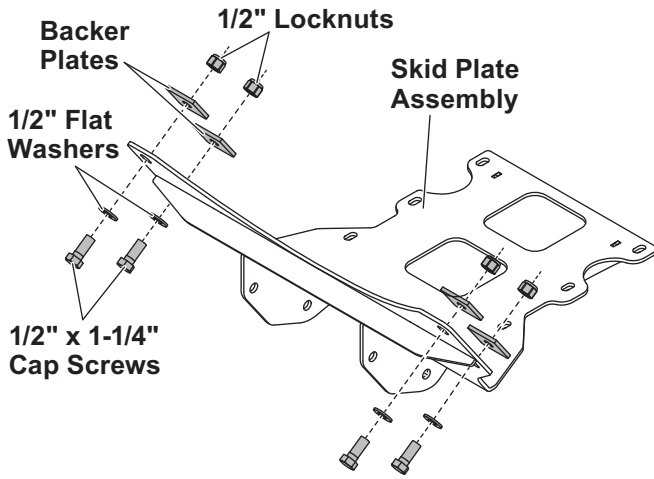

Secure each fastener with a backer plate and locknut.

- Remove all clamps. Tighten all hardware starting at the front of the vehicle and working toward the back.
- Install the mount beam using four 1/2" x 1-1/4" cap screws and 1/2" locknuts. Tighten according to the torque chart.
- Measure the distance between the mount beam rear hole and the ground. If it exceeds 11-1/2", install the accessory Height Adapter Plate Kit (PN 77555) to ensure optimum plowing performance.

NOTE: After five to ten hours of snowplow usage, retorque all mount assembly fasteners.

The company reserves the right under its product improvement policy to change construction or design details and furnish equipment when so altered without reference to illustrations or specifications used. This equipment manufacturer or the vehicle manufacturer may require or recommend optional equipment for snow removal. Do not exceed vehicle ratings with a snowplow. The company offers a limited warranty for all snowplows and accessories. See separately printed page for this important information.