





**PARTS & INSTALLATION INSTRUCTIONS
FRONT 2" RECEIVER MOUNT
SNOW PLOW MOUNTING CARTON 09006
2012 & LATER
KAWASAKI TERYK 750FI UTV**



End user must be given this instruction sheet prior to delivery of Snow Plow.

SAFETY DEFINITIONS



	This is the safety alert symbol. It is used to alert you to potential personal injury hazards. Obey all safety messages that follow this symbol to avoid possible injury or death.
	DANGER Indicates an imminently hazardous situation which, if not avoided, will result in death or serious injury.
	WARNING Indicates a potentially hazardous situation which, if not avoided, could result in death or serious injury.
	CAUTION Indicates an potentially hazardous situation which, if not avoided, may result in minor or moderate injury.
	CAUTION used without the safety alert symbol indicates a potentially hazardous situation which, if not avoided, will result in property damage.

IMPORTANT NOTICE

In conjunction with FMVSS (Federal Motor Vehicle Safety Standards) and OEM (Original Equipment Manufacturer) guidelines, Meyer Products has designed this plow package with the following guidelines:

	Installation of a snowplow may effect your new vehicle warranty. For more information consult your Vehicle Owner's Manual / Vehicle Dealer.
	The vehicle must not be operated when overloaded. In all cases, the loaded vehicle weight, including the entire snowplow system, all aftermarket accessories, driver, passenger, options, nominal fluid levels, and cargo must not exceed the front/rear Gross Axle Weight Rating (GAWR), and total Gross Vehicle Weight Rating (GVWR). These weights ratings are specified on the safety compliance certification label on the driver's side door opening. The use of rear ballast weight may be required to prevent exceeding the front GAWR.

According to the NHTSA (National Highway Traffic Safety Administration) new and untitled vehicles need to be verified by the installer that snowplow and ballast (if needed) do no exceed the front/rear GAWR and total GVWR.

	 Read the Meyer Owner's Manual before operating or servicing a snowplow. FOLLOW THESE INSTRUCTIONS EXPLICITLY.
---	--

GENERAL INFORMATION

	SAFETY PRECAUTIONS should be used when Hydraulic Unit is in OPERATION and plow is in a RAISED position. Lower plow to ground when vehicle is PARKED in case of hydraulic failure.
---	---

Check contents against the parts list to determine all are correct and included, and also to familiarize yourself with them.

	Warranty does not apply to a Meyer product which has been negligently or improperly assembled or installed.
---	---

	CAUTION: To avoid harm to vehicles electrical system always disconnect battery before beginning installation. DO NOT BURN holes or WELD vehicle frame. This may cause frame failure.
---	---

OVERHAUL and SERVICE INFORMATION are covered on separate instructions.

Meyer Products reserves the right, under its continuing product improvement program, to change construction or design details, specifications and prices without notice or without incurring any obligation.

Meyer Products LLC
18513 Euclid Ave. • Cleveland, Ohio 44112-1084
Phone 216-486-1313
www.meyerproducts.com • email info@meyerproducts.com

PARTS LIST

ITEM	PART NO.	QTY.	DESCRIPTION
	09006	1	MOUNTING CARTON
1	-----	1	• Receiver Mount
2	-----	6	• Bolt 5/16-18 X 1"
3	-----	6	• Flatwasher 5/16"
4	-----	6	• Lockwasher 5/16"



Parts indented are included in the carton, bag or assembly under which they are indented.

IMPORTANT

After first use, retighten all mounting bolt connections to specified torque. All mounting bolt connections to be checked periodically for tightness.

Locknuts are furnished **DO NOT** tighten bolts and nuts until installation is complete (unless otherwise specified), then be sure to tighten all attaching parts per specified torque chart.

TORQUE CHART FOOT

Bolt Nut Size	Gr. 2 	Gr. 5 	Gr. 8 
1/4 - 20	4 - 5		
5/16 - 18	9 - 11		
3/8 - 16	17 - 20	26 - 29	
7/16 - 14		42 - 46	60 - 66
1/2 - 13		64 - 72	90 - 100
5/8 - 11		127 - 141	179 - 198

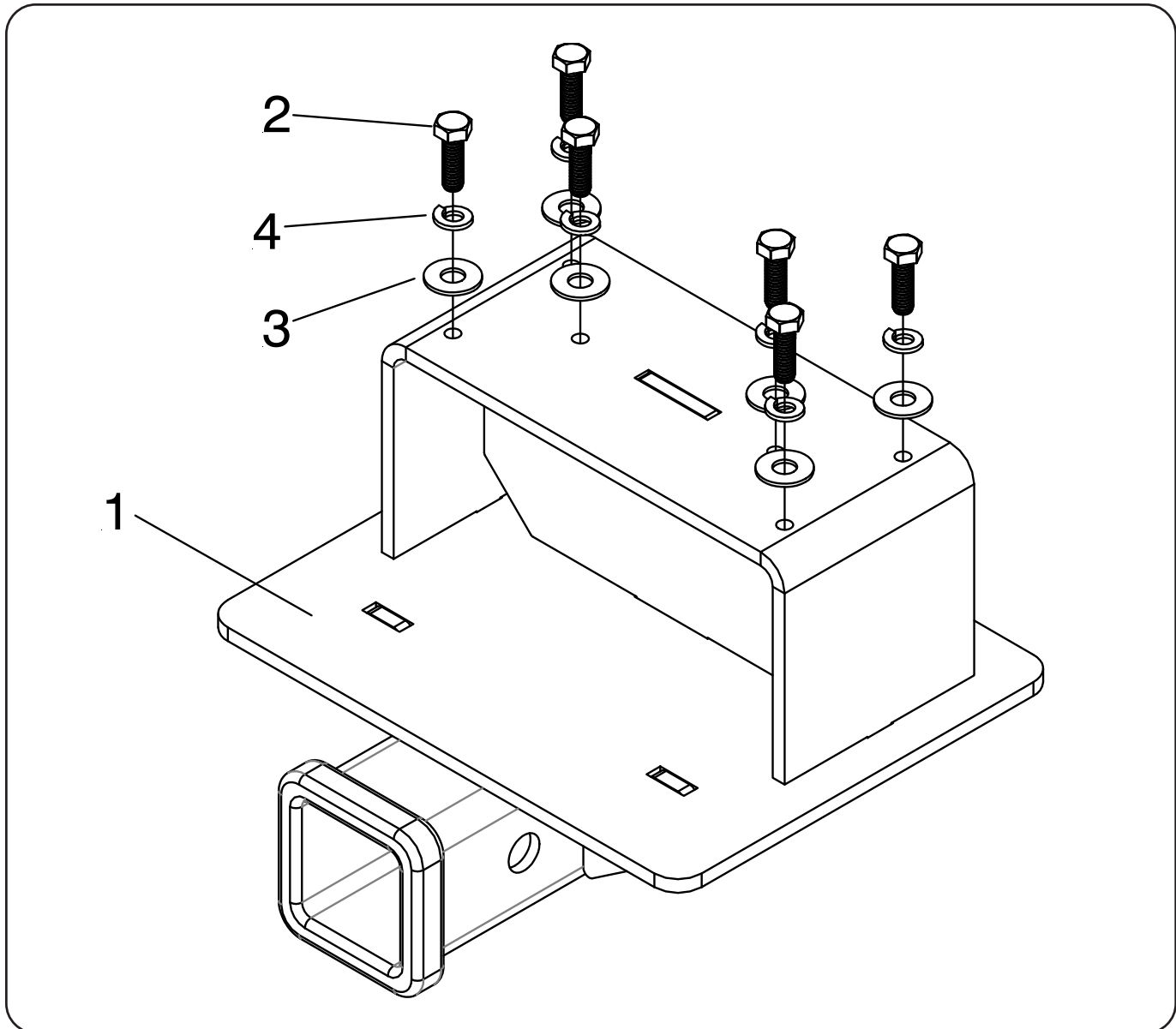

VEHICLE RECOMMENDATIONS

**WARNING**

- Due to weight restrictions on these vehicle's front GAWR, a Drive Pro 6' 8" moldboard is the largest that can safely be installed on a Kawasaki Teryx 750FI. Also limit to driver and one passenger only while plow is installed unless specified below.

**WARNING**

- Ballast weight may be required. Ballast must be securely attached behind the rear axle:

Salt or sand in bags are recommended as ballast.

Rear ballast is determined by weighing a vehicle's front and rear axles and adding weight behind the rear axle until front axle weight is under or equal to the vehicle specific front GAWR while not exceeding the rear GAWR and GVWR.

Vehicle option packages may vary. If in doubt, it is always a good idea to weigh the vehicle to ensure all weight ratings are not exceeded with plow in the raised position.

INSTALLATION INSTRUCTIONS

- A. Vehicle has a plastic or steel guard on the front bumper that needs removed prior to installation of the receiver mount.
- B. Place receiver mount (1) under vehicle. Attach receiver mount (1) using 5/16-18 x 1" bolt (2), 5/16" lockwasher (4) and 5/16" flatwasher (3).
- C. Tighten all fasteners to their proper torque. Tighten bolts in the same order they were assembled to the vehicle.
- D. Install recommended ballast for this vehicle. Using salt or sand bags are suggested for weight.
- E. Install remaining snowplow hardware per separate instructions.

Meyer Products assumes no responsibility for installations not made in accordance with these instructions.