

PARTS & INSTALLATION INSTRUCTIONS

DRIVE PRO™





SNOW PLOW MOUNTING CARTON 18511

2009 & Later RTV 900/1100 Kubota 4X4

Residential Use Only



End user must be given this instruction sheet prior to delivery of Snow Plow.

SAFETY DEFINITIONS



	This is the safety alert symbol. It is used to alert you to potential personal injury hazards. Obey all safety messages that follow this symbol to avoid possible injury or death.
	DANGER Indicates an imminently hazardous situation which, if not avoided, will result in death or serious injury.
	WARNING Indicates a potentially hazardous situation which, if not avoided, could result in death or serious injury.
	CAUTION Indicates an potentially hazardous situation which, if not avoided, may result in minor or moderate injury.
	CAUTION used without the safety alert symbol indicates a potentially hazardous situation which, if not avoided, will result in property damage.

IMPORTANT NOTICE

In conjunction with FMVSS (Federal Motor Vehicle Safety Standards) and OEM (Original Equipment Manufacturer) guidelines, Meyer Products has designed this plow package with the following guidelines:

	Installation of a snowplow may effect your new vehicle warranty. For more information consult your Vehicle Owner's Manual / Vehicle Dealer.
	The vehicle must not be operated when overloaded. In all cases, the loaded vehicle weight, including the entire snowplow system, all aftermarket accessories, driver, passenger, options, nominal fluid levels, and cargo must not exceed the front/rear Gross Axle Weight Rating (GAWR), and total Gross Vehicle Weight Rating (GVWR). These weights ratings are specified on the safety compliance certification label on the driver's side door opening. The use of rear ballast weight may be required to prevent exceeding the front GAWR.

According to the NHTSA (National Highway Traffic Safety Administration) new and untitled vehicles need to be verified by the installer that snowplow and ballast (if needed) do no exceed the front/rear GAWR and total GVWR.

	 Read the Meyer Owner's Manual before operating or servicing a snowplow. FOLLOW THESE INSTRUCTIONS EXPLICITLY.
---	--

GENERAL INFORMATION

	SAFETY PRECAUTIONS should be used when Hydraulic Unit is in OPERATION and plow is in a RAISED position. Lower plow to ground when vehicle is PARKED in case of hydraulic failure.
---	---

Check contents against the parts list to determine all are correct and included, and also to familiarize yourself with them.

	Warranty does not apply to a Meyer or Diamond product which has been negligently or improperly assembled or installed.
---	--

	CAUTION: To avoid harm to vehicles electrical system always disconnect battery before beginning installation. DO NOT BURN holes or WELD vehicle frame. This may cause frame failure.
---	---

OVERHAUL and SERVICE INFORMATION are covered on separate instructions.

Meyer Products and Diamond Equipment reserves the right, under its continuing product improvement program, to change construction or design details, specifications and prices without notice or without incurring any obligation.

Meyer Products LLC
18513 Euclid Ave. • Cleveland, Ohio 44112-1084
Phone 486-1313 (Area Code 216)
www.meyerproducts.com • email info@meyerproducts.com



Meyer Products LLC
6 Angell Lane • Damariscotta, ME 04543-4507
Phone 563-2227 (Area Code 207)
www.meyerproducts.com • email info@meyerproducts.com

PARTS LIST

ITEM	PART NO.	QTY.	DESCRIPTION
	18511	1	MOUNTING CARTON
1	19128	1	• Mounting Weldment
2	10514	1	• Lift Arm
3	19709	1	• Jack Stand
4	19166	1	• Brace
	08892	1	• HARDWARE BAG
5	20049	2	•• Bolt H 3/8-16 x 1"
6	22138	6	•• Bolt M12 x 1.25 Px40mm Gr8
7	20305	2	•• Locknut 3/8-16
8	21991	6	•• Lockwasher 12mm
	08142	1	• HARDWARE BAG
9	07354	1	•• Cap Plug
10	19703	1	•• Lever Jack
11	20357	3	•• Flatwasher 5/8
12	20385	3	•• Cotter Pin 1-1/4 x 1/8"
13	22399	1	•• Wire Linch Pin
14	22719	3	•• Pivot Pin 5/8 x 3"
15	814000005	1	•• Spring
	P.A.F.		MEYER
	PART NO.	QTY.	DESCRIPTION
	16600	1	Pivot A-Frame Carton



Parts indented are included in the carton, bag or assembly under which they are indented.

IMPORTANT

After first use, retighten all mounting bolt connections to specified torque. All mounting bolt connections to be checked periodically for tightness.

Locknuts are furnished **DO NOT** tighten bolts and nuts until installation is complete (unless otherwise specified), then be sure to tighten all attaching parts per specified torque chart.

TORQUE CHART FOOT

Bolt Nut Size	Gr. 	Gr. 	Gr. 
1/4 - 20	4 - 5	5	8
5/16 - 18	9 - 11		
3/8 - 16	17 - 20	26 - 29	
7/16 - 14		42 - 46	60 - 66
1/2 - 13		64 - 72	90 - 100
5/8 - 11		127 - 141	179 - 198

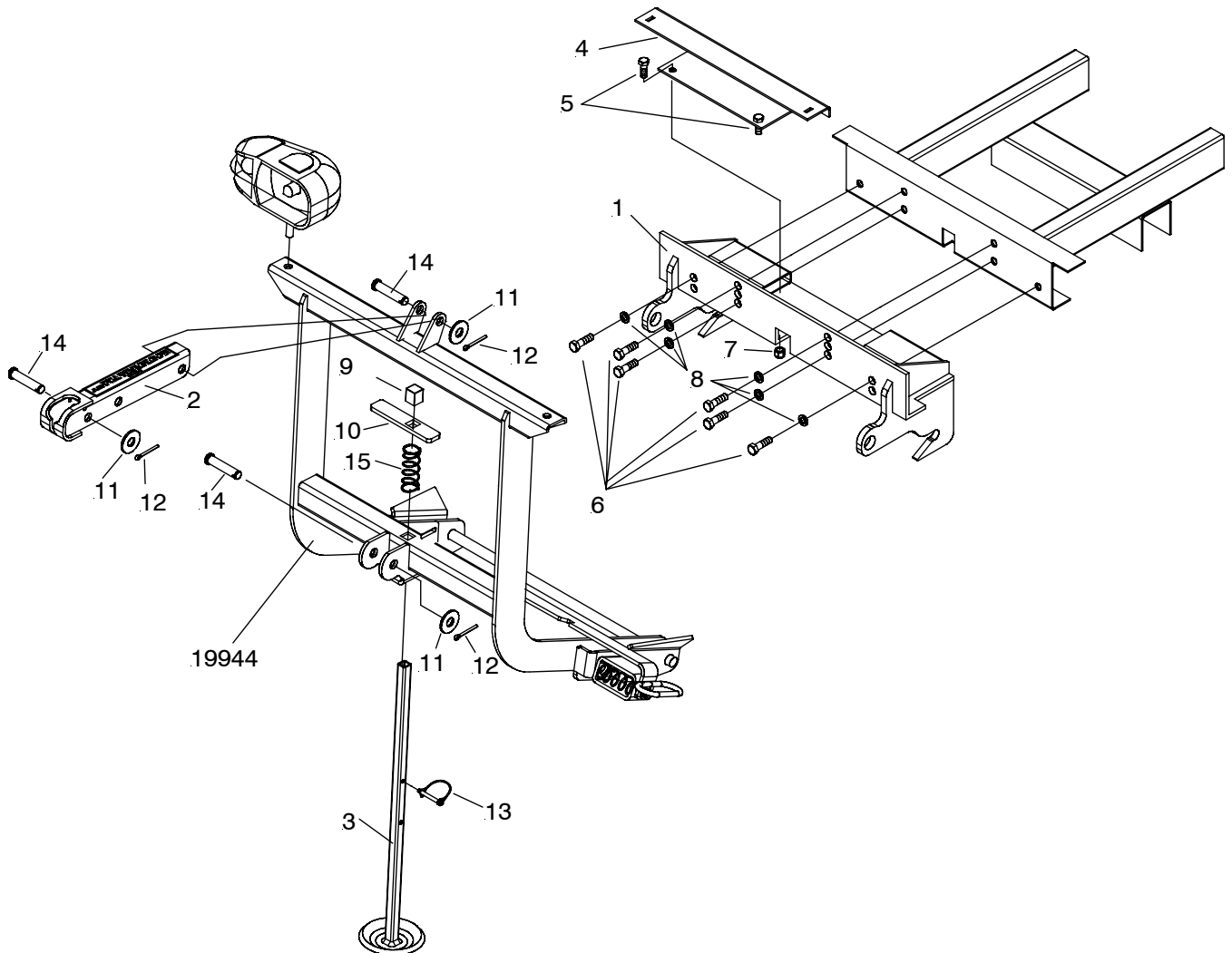

VEHICLE RECOMMENDATIONS



- Due to weight restrictions on these vehicle's front GAWR, a Drive Pro 6' moldboard is the largest that can safely be installed on a Kubota 4X4.



- Ballast weight is not required on the Kubota models.
- Front end wheel alignment and headlight aim may require readjustment after installation of equipment, and is the responsibility of the equipment installer. Failure to adjust front wheel alignment may cause premature uneven tire wear. If required, reset to chassis manufacturer's specifications found in the Polaris Shop Manual.

Rear ballast is determined by weighing a vehicle's front and rear axles and adding weight behind the rear axle until front axle weight is under or equal to the vehicle specific front GAWR while not exceeding the rear GAWR and GVWR.

Vehicle option packages may vary. If in doubt, it is always a good idea to weigh the vehicle to ensure all weight ratings are not exceeded with plow in the raised position.

INSTALLATION INSTRUCTIONS

- Remove vehicle bumper valance from front of vehicle frame, save to reinstall.
- For 2010 models **ONLY** attach **Brace (4)** to **Mounting Weldment (1)** using **3/8-16 x 1" Bolt (5)** and **3/8-16 Locknut (7)**. Position Mounting Weldment (1) to frame of vehicle. Attach to frame using M12 x 1.25 Px40mm Bolt (6) and 12mm Lockwasher (8).
- Tighten all fasteners to their proper torque. Tighten bolts in the same order they were assembled to the vehicle.
- Install recommended ballast for this vehicle. Using salt or sand bags are suggested for weight.
- Install remaining snowplow hardware per separate instructions.
- Slide Jack Stand (3) thru bottom of Lift frame, Spring (15) and Jack Lever (10). **Be sure short side of Jack Lever (10) is oriented into the slot of the Lift Frame.** **Note: Wire Lynch Pin (13) is used to Lock the Jack**

Stand (3) in the raised position once the plow is attached to the vehicle.

- Attach Lift Frame to Clevis Frame (1). Twist the Handle Pin so that the two Pins engage. The spring loaded pin should snap into place locking the lift frame to the clevis frame.
- Attach Lift Arm (2) to Lift Frame, Mount Hydraulic unit to lift frame and to lift arm (2) using Pivot Pin (14), 5/8" Washer (11) and 1/8 x 1-1/4" Cotter Pin (12).
- Install hydraulic system and light system per separate instructions.
- Pre-Assemble Moldboard Assembly per separate instructions.
- Attach the Lift Chain to the Lift Arm (2) through the hook on the lift arm. Adjust the lift chain at the lift arm so that there are 2-3 links of slack. This ensures that the plow blade will lift fully and be able to follow the ground contour while plowing.

DETACHING THE COMPLETE ASSEMBLY

Leave control switch in lower float position and push down on the Lift Arm (2) approximately 1/4". Disconnect the electrical plug and slip on weather caps over the both ends. Remove Safety Clip from jackstand. Push Jackstand Lever down, until it is parallel with the cross bar of the Lift Frame, to lower Jackstand to ground. At the same time push the top of the Lift Frame up and towards the vehicle. Reinstall Safety Clip to Jackstand below the lift frame. Pull, then rotate Handle so the notch hooks onto the bracket on lift frame. The vehicle is now free from mount and may safely back away.

ATTACHING THE COMPLETE ASSEMBLY

Check that the Handle Pin is disengaged. Drive the truck up to the Drive Pro™ assembly centering the hood of the truck to the lift arm to assure proper alignment with lift frame guide plates until contact is made. Once contact is made drive forward, pushing the assembly a few inches. This insures the A-Frame is square to the Clevis Frame for proper pin attachment. The rear fixed Pins should now be aligned with the rear notched hole on the clevis frame (1). Twist Handle Pin to unlock so that the pins become spring loaded then push the top of the Lift Frame towards the truck locking the front pins to the clevis frame. Remove Safety Clip from jackstand. Push Jackstand Lever down and raise Jackstand to storage position. Reinstall Safety Clip to Jackstand above the lift frame. **Note: Wire Lynch Pin (13) is used to Lock the Jack Stand (3) in the raised position once the plow is attached to the vehicle.**

Caution: Crankstand must be secured at all times.

Reattach the one step electrical connection.



Be sure that load is secure while transporting. With ballast weight in place, be sure that only the driver is in vehicle while plowing to avoid overloading.

Meyer Products or Diamond Equipment assumes no responsibility for installations not made in accordance with these instructions.