

49663, 49664, 49665

Wiring Conversion Kits

Parts List and Installation Instructions

⚠ CAUTION

Read this document before installing the snowplow.

⚠ CAUTION

See your sales outlet/Web site for specific vehicle application recommendations before installation. The online selection tool has specific vehicle and snowplow requirements.

PARTS LIST

Wiring Conversion Kits – Straight Blades				
Part	Description	Qty		
		49663	49664	49665
21294	Plow Battery Cable	1		1
26345	Vehicle Control Harness – 3-Pin		1	1
26359	Plow Control Harness – 3-Pin	1		1
22511	Battery Cable – 22" Red		1	1
63411	Vehicle Battery Cable		1	1
5794K-1	Motor Relay Kit		1	1
29047	Adapter		1	1
61548	Plug Cover	1	1	1
–	1/4 Fasteners		1	1
–	Dielectric Grease		1	

SAFETY DEFINITIONS

WARNING

Indicates a potentially hazardous situation that, if not avoided, could result in death or serious personal injury.

CAUTION

Indicates a potentially hazardous situation that, if not avoided, may result in minor or moderate injury. It may also be used to alert against unsafe practices.

NOTE: Indicates a situation or action that can lead to damage to your snowplow and vehicle or other property. Other useful information can also be described.

FUSES

The snowplow electrical and hydraulic systems contain several blade-style automotive fuses. If a problem should occur and fuse replacement is necessary, the replacement fuse must be of the same type and amperage rating as the original. Installing a fuse with a higher rating can damage the system and could start a fire. Fuse Replacement, including fuse ratings and locations, is located in the Maintenance Section of the Owner's Manual.

BATTERY SAFETY

CAUTION









Batteries normally produce explosive gases, which can cause personal injury. Therefore, do not allow flames, sparks or lit tobacco to come near the battery. When charging or working near a battery, always cover your face and protect your eyes, and also provide ventilation.

- Batteries contain sulfuric acid, which burns skin, eyes and clothing.
- Disconnect the battery before removing or replacing any electrical components.

TORQUE CHART

CAUTION

Read instructions before assembling. Fasteners should be finger tight until instructed to tighten according to the torque chart. Use standard methods and practices when attaching snowplow, including proper personal protective safety equipment.

Recommended Fastener Torque Chart					
Inch Fasteners Grade 5 and Grade 8					
Size	Torque (ft-lb)		Size	Torque (ft-lb)	
	 Grade 5	 Grade 8		 Grade 5	 Grade 8
1/4-20	8.4	11.9	9/16-12	109	154
1/4-28	9.7	13.7	9/16-18	121	171
5/16-18	17.4	24.6	5/8-11	150	212
5/16-24	19.2	27.3	5/8-18	170	240
3/8-16	30.8	43.6	3/4-10	269	376
3/8-24	35.0	49.4	3/4-16	297	420
7/16-14	49.4	69.8	7/8-9	429	606
7/16-20	55.2	77.9	7/8-14	474	669
1/2-13	75.3	106.4	1-8	644	909
1/2-20	85.0	120.0	1-12	704	995
Metric Fasteners Class 8.8 and 10.9					
Size	Torque (ft-lb)		Size	Torque (ft-lb)	
	 Class 8.8	 Class 10.9		 Class 8.8	 Class 10.9
M6 x 1.00	7.7	11.1	M20 x 2.50	325	450
M8 x 1.25	19.5	26.9	M22 x 2.50	428	613
M10 x 1.50	38.5	53.3	M24 x 3.00	562	778
M12 x 1.75	67	93	M27 x 3.00	796	1139
M14 x 2.00	107	148	M30 x 3.50	1117	1545
M16 x 2.00	167	231	M33 x 3.50	1468	2101
M18 x 2.50	222	318	M36 x 4.00	1952	2701
These torque values apply to fasteners except those noted in the instructions.					

INSTALLATION INSTRUCTIONS

Plow-Side Wiring

1. Remove the hydraulic unit cover according to the snowplow Installation Instructions.
2. Remove all of the wiring and electrical components from the hydraulic unit including the module and bracket, motor relay, control harness, and plow cable. Note the routing and position of clamps or cable ties on the plow cable and control harness.

3. Attach the new control harness to the solenoid valve coils and motor terminal as shown.
4. Attach the new plow cable to the motor terminals as shown.
5. Route the cable and harness as noted in Step 2. Use cable ties to securely attach the control harness to the plow cable where it exits the cover.
6. Re-install the cover.

NOTE: Snowplow lighting and control harnesses plug into one another for storage.

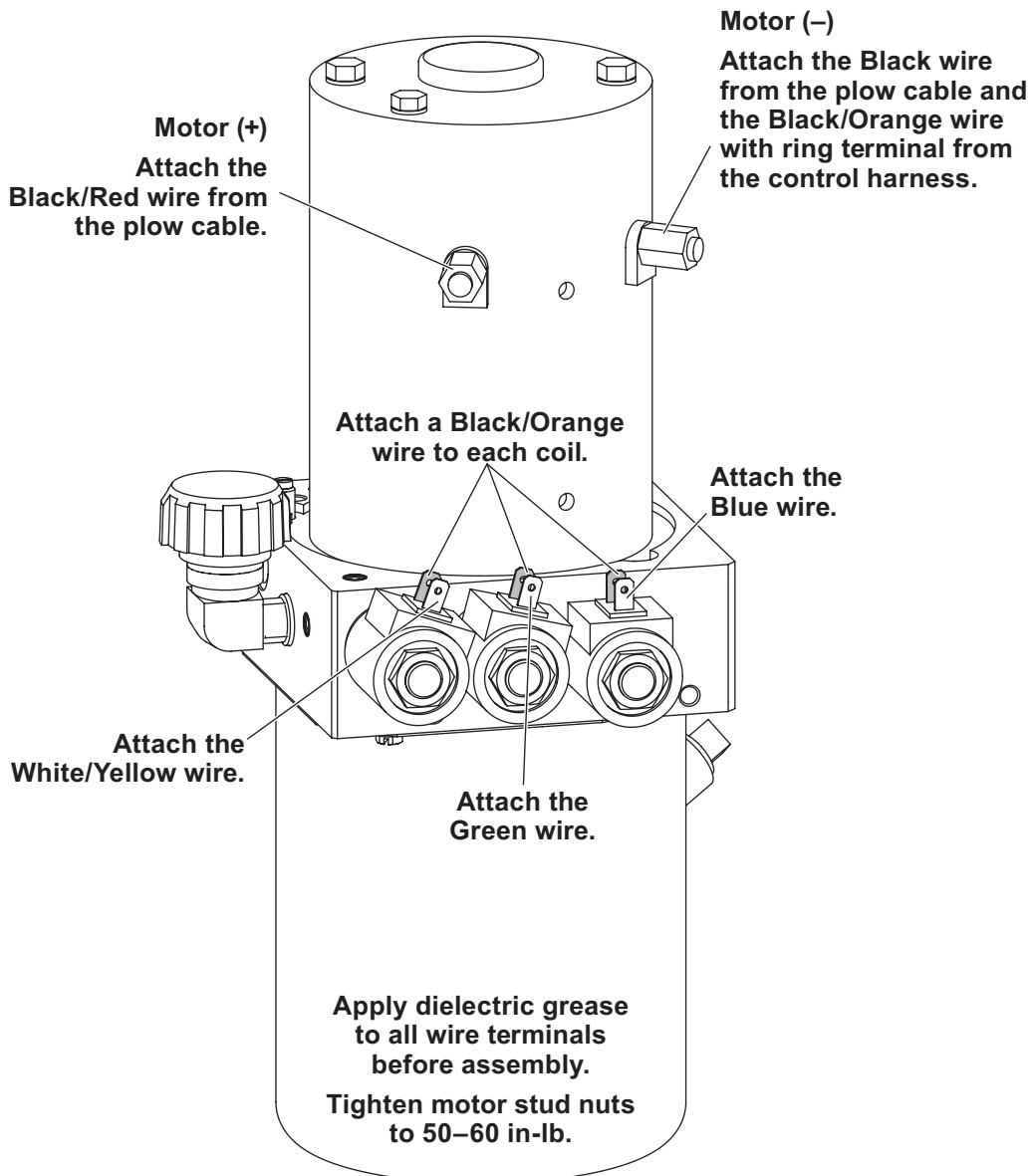

TYPICAL 3-PLUG, 3-PORT MODULE SYSTEM DIAGRAM

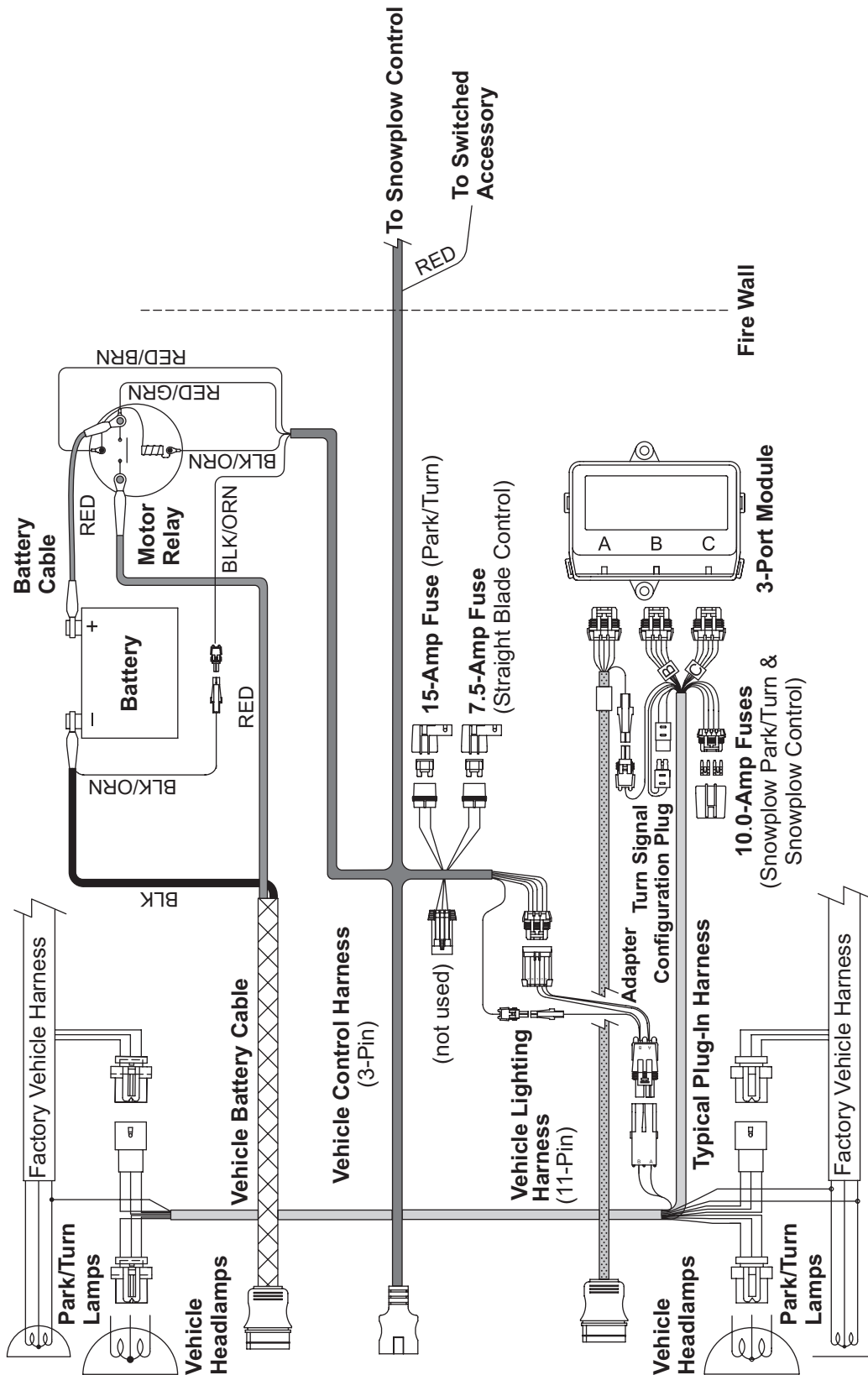

Motor Relay and Vehicle Battery Cable Installation

⚠ CAUTION

Batteries normally produce explosive gases, which can cause personal injury. Therefore, do not allow flames, sparks or lit tobacco to come near the battery. When charging or working near a battery, always cover your face and protect your eyes, and also provide ventilation.

- Batteries contain sulfuric acid, which burns skin, eyes and clothing.
- Disconnect the battery before removing or replacing any electrical components.

NOTE: When instructed, make all snowplow battery cable connections to the auxiliary battery, if vehicle is so equipped.

NOTE: For vehicles equipped with a tilt cab or tilt hood, a service loop will be necessary when making harness or cable transitions from the cab/hood to the frame. Check the cable installation for interference by raising and lowering the cab/hood a number of times. Add anti-chafing material (installer-supplied) as needed.

1. Turn the vehicle ignition OFF.
2. Disconnect both the NEGATIVE (-) and the POSITIVE (+) battery cables.
3. Choose a location on the vehicle where the motor relay will be protected from road splash and debris. Motor relay must be within 18" of the vehicle battery. (The motor relay can be farther from the battery if the battery cable provided with either the plug-in harness or adapter kit is longer than 22".)

NOTE: Position motor relay terminals up, horizontal or in between.

⚠ CAUTION

Before installing self-drilling screws or drilling mounting holes, check the selected mounting area for any wires, hoses or other obstructions.

4. Drill two 9/32" mounting holes using the motor relay mounting plate as a template. Mount the motor relay using 1/4" x 3/4" cap screws, washers and locknuts.
5. Route the supplied vehicle battery cable from the grille or bumper to the location chosen for mounting the motor relay, avoiding any sharp edges and hot or moving parts. Cable tie only the end section closest to the grille. Lengthening the vehicle battery cable may be necessary on vehicles with batteries located under or behind the cab. If lengthening cables is necessary, use the same gauge wire as the vehicle battery cable, and cover all connections with dual-wall heatshrink tubing to prevent shorting.

⚠ CAUTION

Overtightening terminal attaching nuts may cause seal failure, resulting in premature failure of motor relay.

6. Attach the red wire from the vehicle battery cable to the one of the large terminals on the motor relay. Secure with a lock washer and 5/16" nut, and tighten to a maximum of 35 in-lb.

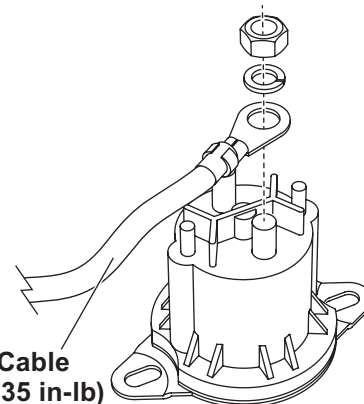

Red Vehicle Battery Cable
(Tighten nut to max. 35 in-lb)

NOTE: Use dielectric grease on all electrical connections to prevent corrosion. Fill receptacles and lightly coat ring terminals before assembly.

7. Route the black wire from the vehicle battery cable to the NEGATIVE (-) battery terminal. Do not connect at this time. On vehicles with the batteries located under or behind the cab, connect the black wire from the vehicle battery cable to the frame using an existing hole or ground bolt. Prior to attaching, clean away any paint or dirt to ensure a good ground connection. The black/orange wire from the vehicle battery cable will connect to the mating connector on the vehicle control harness.

Plug Cover Installation

1. Stretch the rectangular opening of the plug cover strap over the end of the vehicle battery cable. Place the plug cover over the molded plug when snowplow is not in use.

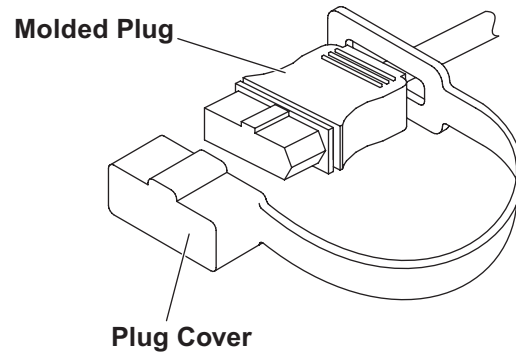

Vehicle Control Harness Installation

Vehicle lighting and vehicle control harnesses are designed to plug into one another when the snowplow is not attached. Plug the harnesses together before cable-tying them to ensure adequate length.

NOTE: For vehicles equipped with a tilt cab or tilt hood, a service loop will be necessary when making harness or cable transitions from the cab/hood to the frame. Check the cable installation for interference by raising and lowering the cab/hood a number of times. Add anti-chafing material (installer-supplied) as needed.

1. Route harness around or through the radiator bulkhead to the Isolation Module.
2. Make the following connections:
 - Single-wire connector from vehicle control harness to single-wire connector from adapter included with harness kit.
 - 4-position connector from adapter included with harness kit to 4-position connector from plug-in harness.

NOTE: The 3-position connector on the vehicle control harness (4-port module configuration plug) will not be used. Cover the terminals with dielectric grease and cap off with electrical tape.

3. Route the end of the vehicle control harness with the white 6-pin connector to the fire wall. Route the vehicle control harness breakout with four wires to the motor relay.

CAUTION

Overtightening terminal attaching nuts may cause seal failure, resulting in premature failure of motor relay.

Motor relay small terminal connections:

Straight blades: brown/red and black/orange

Secure the wires to the small terminals of the motor relay with #10 lock washers and 10-32 nuts, and tighten to a maximum 15 in-lb.

4. Connect the single-wire connector (black/orange wire) from the vehicle control harness breakout to the single-wire connector (black/orange wire) from the vehicle battery cable. Do not cable tie the harness at this time.
5. Attach the supplied red battery cable and the red-green wire from the vehicle control harness to a large terminal on the motor relay with a lock washer and 5/16" nut, and tighten to a maximum 35 in-lb. Route the supplied red battery cable between the motor relay terminal and the POSITIVE (+) battery terminal, avoiding sharp edges and hot or moving parts. Do not make a battery connection at this time.

CAUTION

Before installing self-drilling screws or drilling mounting holes, check the selected mounting area for any wires, hoses or other obstructions.

6. On the driver's side, locate an existing hole through the fire wall for the vehicle control harness. If access through the fire wall does not exist, drill a 5/8" hole through the fire wall of the vehicle in a convenient location away from sharp edges and hot or moving parts.

7. Carefully push the end of the harness through the fire wall hole into the cab. Use a grommet, existing plug cover, or proper anti-chafing material to protect the harness where it passes through the fire wall. Route the harness to the selected control mounting location. To mount the control, follow the instructions supplied with the control.
8. Locate an accessory wire controlled by the ignition switch. Acceptable accessory wires show +12V when the ignition switch is ON, and 0V when it is OFF.
9. Route the red wire from the vehicle control harness to this location and trim away excess length.
10. Following the recommended splicing procedure, splice the red wire into the switched accessory wire using the supplied parallel splices and heatshrink tubing.

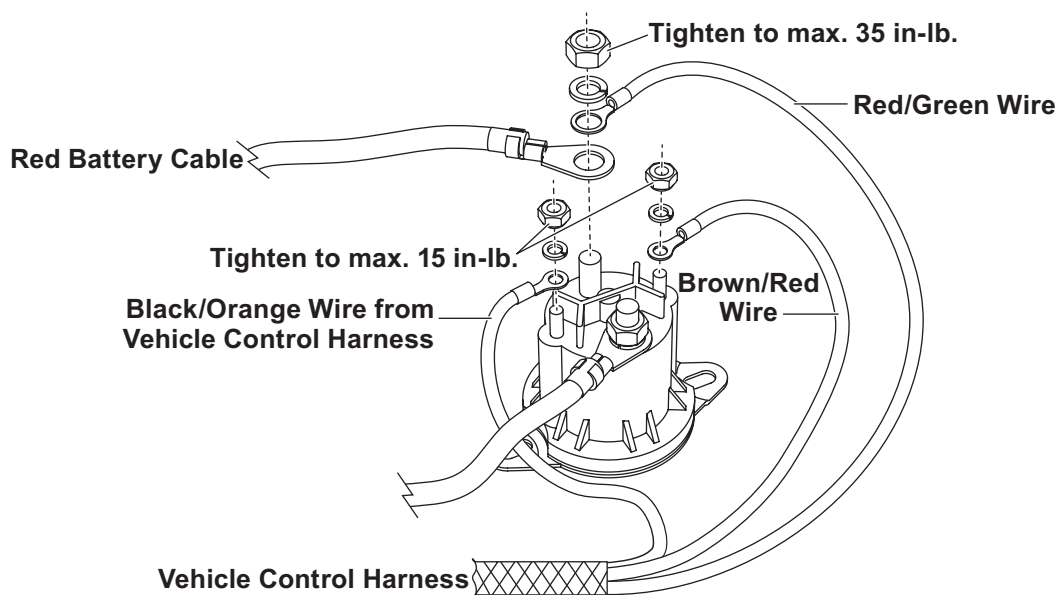

Recommended Splicing Procedure

1. Locate the wire to be spliced into.
2. Cut the wire at least 1-1/2" from any other splice, connector or terminal. If the wires are covered by tubing or braid, remove enough of it to achieve the minimum clearance required.
3. Strip away 5/16" of the insulation from the ends of the wires to be spliced.
4. Slide two wires into one end of the supplied parallel splice.
5. Place a piece of heatshrink tubing (3/16" x 1-1/4" long) over the remaining wire to be spliced. Cut tubing into 1-1/4" lengths if required.
6. Insert the wire into the open end of the splice and crimp using an appropriate crimp tool. One or two crimps may be necessary to ensure a good connection. No wire strands should be visible outside of the splice.
7. Preheat a soldering tool for at least one minute to help promote even solder flow.
8. Apply heat to the splice. Avoid heating too close to the insulation. Apply solder to the wires. Use just enough solder to produce an even flow through the splice. **Use rosin-core solder ONLY. Do not use acid-core solder.**

NOTE: Avoid using an excessive amount of solder as it can result in wicking. Wicking occurs when solder travels up the wire core. This may cause the wire to become stiff or brittle which could lead to a broken or open circuit.

9. Check circuits for continuity.
10. Cover the splice with the heatshrink tubing. The tubing should extend beyond the splice on both sides.
11. Using a hot air source, starting in the center and working to either side, apply heat until the tubing recovers and glue can be seen around the edges. Allow the tubing to cool before handling.

NOTE: The splices supplied will accommodate 18-gauge wires as shown. For larger gauge wires, cut the wire, strip the ends 3/8" to 1/2" and twist together. Apply solder to the splice and cover with heatshrink tubing.

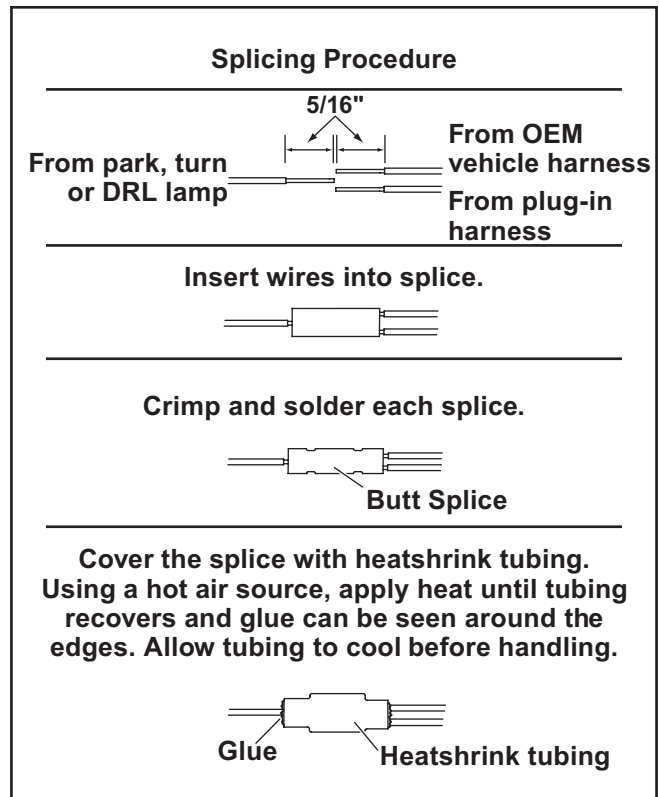

Battery Cable Connections

Top Post Batteries w/Lead Cable Ends

1. Attach the POSITIVE (+) OEM cable to the battery post. Attach the red battery cable to the bolt in the OEM terminal with the original fastener.
2. Attach the NEGATIVE (-) OEM cable to the battery post. Attach the black wire from the vehicle battery cable to the OEM terminal bolt with the original fastener.

Top Post Batteries w/Stamped Steel Battery Terminals — Style 1

These terminals are secured with a 6 mm washer-head cap screw and nut.

1. If the cap screw is long enough for the added thickness of the cable terminal, washer and nut, it will not need to be replaced, and Step 2 may be skipped.
2. Carefully lift the retainer tabs (if present), and remove the short cap screw. Insert a longer cap screw through a 3/16" washer and into the hole in the clamp. Carefully bend the retainer tabs back into place.
3. Attach the POSITIVE (+) OEM battery clamp to the battery post and secure the clamp.

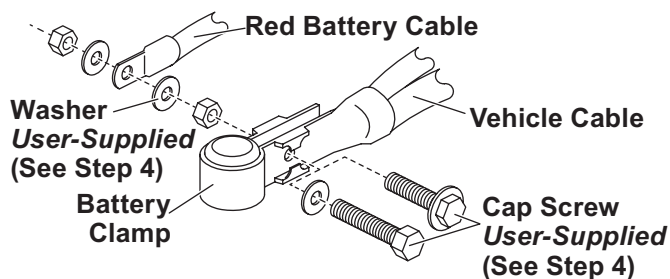

4. Place the red battery cable over the end of the battery terminal screw. If the added terminal has a large contact area with the battery clamp, retain with a washer and nut. If the terminal contact area is small (terminal hole almost passes over a 6 mm nut), add a washer to both sides of the cable, and secure with a nut.

5. Connect the black wire from the vehicle battery cable and the OEM NEGATIVE (-) cable to the NEGATIVE (-) battery terminal following the same procedure used in Steps 1–4.

Top Post Batteries w/Stamped Steel Battery Terminals — Style 2

These terminals are secured with a 6 mm tapered nut and cam.

1. Make the connections to the POSITIVE (+) terminal as follows:
 - a. Remove the cable assembly from the battery post by loosening the nut. Trim the plastic terminal cover as shown.

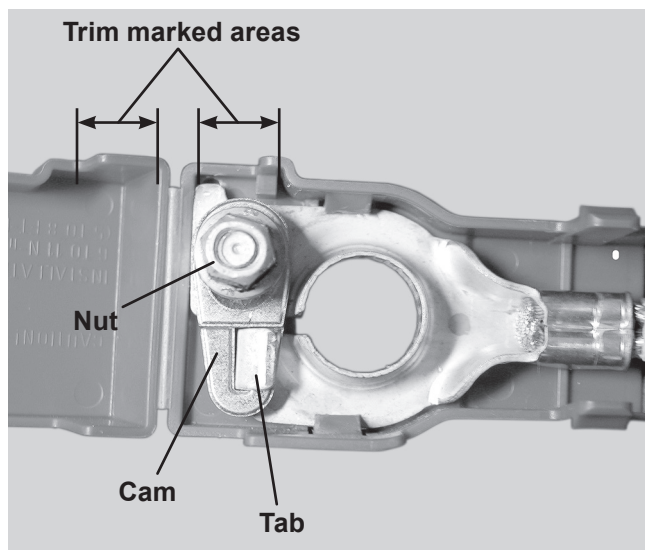

- b. Carefully bend the tab securing the cam upward so the cam can be lifted off the stamped terminal after the nut has been removed.
- c. Place the red battery cable over the battery terminal screw.
- d. Slide the cam over the terminal screw and tab. Reinstall the nut.
- e. Place the cable assembly on the battery post, align the red battery cable with the opening in the cover, and tighten the nut. Close the plastic terminal cover.

2. Make the connections to the NEGATIVE (-) terminal as follows:
 - a. Remove the cable assembly from the battery post by loosening the nut.
 - b. Carefully bend the tab securing the cam upward so the cam can be lifted off the stamped terminal after the nut has been removed.
 - c. Place the black wire from the vehicle battery cable over the battery terminal screw.
 - d. Slide the cam over the terminal screw and tab. Reinstall the nut.
 - e. Place the cable assembly on the battery post, and tighten the nut.
- c. Place the cable assembly on the battery post, align the red battery cable with the opening in the cover, and tighten the nut. Close the plastic terminal cover.
2. Make the connections to the NEGATIVE (-) terminal as follows:
 - a. Remove the cable assembly from the battery post by removing the nut.
 - b. Place the black wire from the vehicle battery cable over the battery terminal screw and reinstall the nut.
 - c. Place the cable assembly on the battery post, and tighten the nut.

Top Post Batteries w/Stamped Steel Battery Terminals — Style 3

These terminals are similar to Style 1, but do not have a visible cam or tab.

1. Make the connections to the POSITIVE (+) terminal as follows:
 - a. Remove the cable assembly from the battery post by removing the nut. Trim the plastic terminal cover as necessary to accommodate the red snowplow battery cable.
 - b. Place the red battery cable over the battery terminal screw and reinstall the nut.
1. Use the furnished battery cable adapter to attach the red battery cable to the POSITIVE (+) terminal of the battery. Position the cable and tighten the adapter to 124–178 in-lb.
2. Connect the OEM POSITIVE (+) cable to the adapter on the battery. Position the cable and, while holding the adapter, tighten the battery cable bolt to 124–178 in-lb.
3. Connect the black wire from the vehicle battery cable and the OEM NEGATIVE (-) cable to the NEGATIVE (-) battery terminal following the same procedure used in Steps 1 and 2.

Side Terminal Batteries

The company reserves the right under its product improvement policy to change construction or design details and furnish equipment when so altered without reference to illustrations or specifications used. This equipment manufacturer or the vehicle manufacturer may require or recommend optional equipment for snow removal. Do not exceed vehicle ratings with a snowplow. The company offers a limited warranty for all snowplows and accessories. See separately printed page for this important information.