

77533

HARNESS KIT

3-PORT ISOLATION MODULE

LIGHT SYSTEM

LED/HALOGEN VEHICLE LIGHTING

Parts List and Installation Instructions

⚠ CAUTION

Read this document before installing the snowplow.

⚠ CAUTION

See your sales outlet/website for specific vehicle application recommendations before installation. The online selection system has specific vehicle and snowplow requirements.

PARTS LIST

Plug-In Harnesses			
Part	Description	Qty	
		77533	90730
77532	Plug-In Harness, 8-Pin	1	
69793-1	Vehicle Lighting Harness, 11-Pin w/Relays, HID	1	
29071	8" Cable Assembly		1
95837	Fuse Holder		1
90729	200A Fuse		1
-	Reclosable Fasteners	4	
-	Splices	1	
-	Heatshrink Tubing	1	

LED Plow Light Kit		
Part	Description	Qty
72565	Headlamp Control Module (HCM)	1
72554	Harness Assembly – HCM to Isolation Module	1
72546	Vehicle Harness Assembly – HCM to Grille	1
72548	Harness Assembly – Plow Lighting	1
72550	Cable Assembly – HCM	1
72552	Wire Assembly – EdgeView™ Lights	1
-	Reclosable Fasteners	4

SAFETY DEFINITIONS

WARNING

Indicates a potentially hazardous situation that, if not avoided, could result in death or serious personal injury.

CAUTION

Indicates a potentially hazardous situation that, if not avoided, may result in minor or moderate injury. It may also be used to alert against unsafe practices.

NOTE: Indicates a situation or action that can lead to damage to your snowplow and vehicle or other property. Other useful information can also be described.

FUSES

The snowplow electrical and hydraulic systems contain several automotive-style fuses. If a problem should occur and fuse replacement is necessary, the replacement fuse must be of the same type and amperage rating as the original. Installing a fuse with a higher rating can damage the system and could start a fire. Fuse Replacement, including fuse ratings and locations, is located in the Maintenance section of the Owner's Manual.

BATTERY SAFETY

CAUTION









Batteries normally produce explosive gases, which can cause personal injury. Therefore, do not allow flames, sparks, or lit tobacco to come near the battery. When charging or working near a battery, always cover your face and protect your eyes, and also provide ventilation.

- Batteries contain sulfuric acid, which burns skin, eyes, and clothing.
- Disconnect the battery before removing or replacing any electrical components.

TORQUE CHART

CAUTION

Read instructions before assembling. Fasteners should be finger tight until instructed to tighten according to the torque chart. Use standard methods and practices when attaching snowplow, including proper personal protective safety equipment.

Recommended Fastener Torque Chart					
Inch Fasteners Grade 5 and Grade 8					
Size	Torque (ft-lb)		Size	Torque (ft-lb)	
	 Grade 5	 Grade 8		 Grade 5	 Grade 8
1/4-20	8.4	11.9	9/16-12	109	154
1/4-28	9.7	13.7	9/16-18	121	171
5/16-18	17.4	24.6	5/8-11	150	212
5/16-24	19.2	27.3	5/8-18	170	240
3/8-16	30.8	43.6	3/4-10	269	376
3/8-24	35.0	49.4	3/4-16	297	420
7/16-14	49.4	69.8	7/8-9	429	606
7/16-20	55.2	77.9	7/8-14	474	669
1/2-13	75.3	106.4	1-8	644	909
1/2-20	85.0	120.0	1-12	704	995
Metric Fasteners Class 8.8 and 10.9					
Size	Torque (ft-lb)		Size	Torque (ft-lb)	
	 Class 8.8	 Class 10.9		 Class 8.8	 Class 10.9
M6 x 1.00	7.7	11.1	M20 x 2.50	325	450
M8 x 1.25	19.5	26.9	M22 x 2.50	428	613
M10 x 1.50	38.5	53.3	M24 x 3.00	562	778
M12 x 1.75	67	93	M27 x 3.00	796	1139
M14 x 2.00	107	148	M30 x 3.50	1117	1545
M16 x 2.00	167	231	M33 x 3.50	1468	2101
M18 x 2.50	222	318	M36 x 4.00	1952	2701
These torque values apply to fasteners except those noted in the instructions.					

TYPICAL 2-PLUG, 3-PORT MODULE LED VEHICLE LIGHTING SYSTEM DIAGRAM

NOTE: On 2-plug electrical systems, plug covers shall be used whenever snowplow is disconnected.

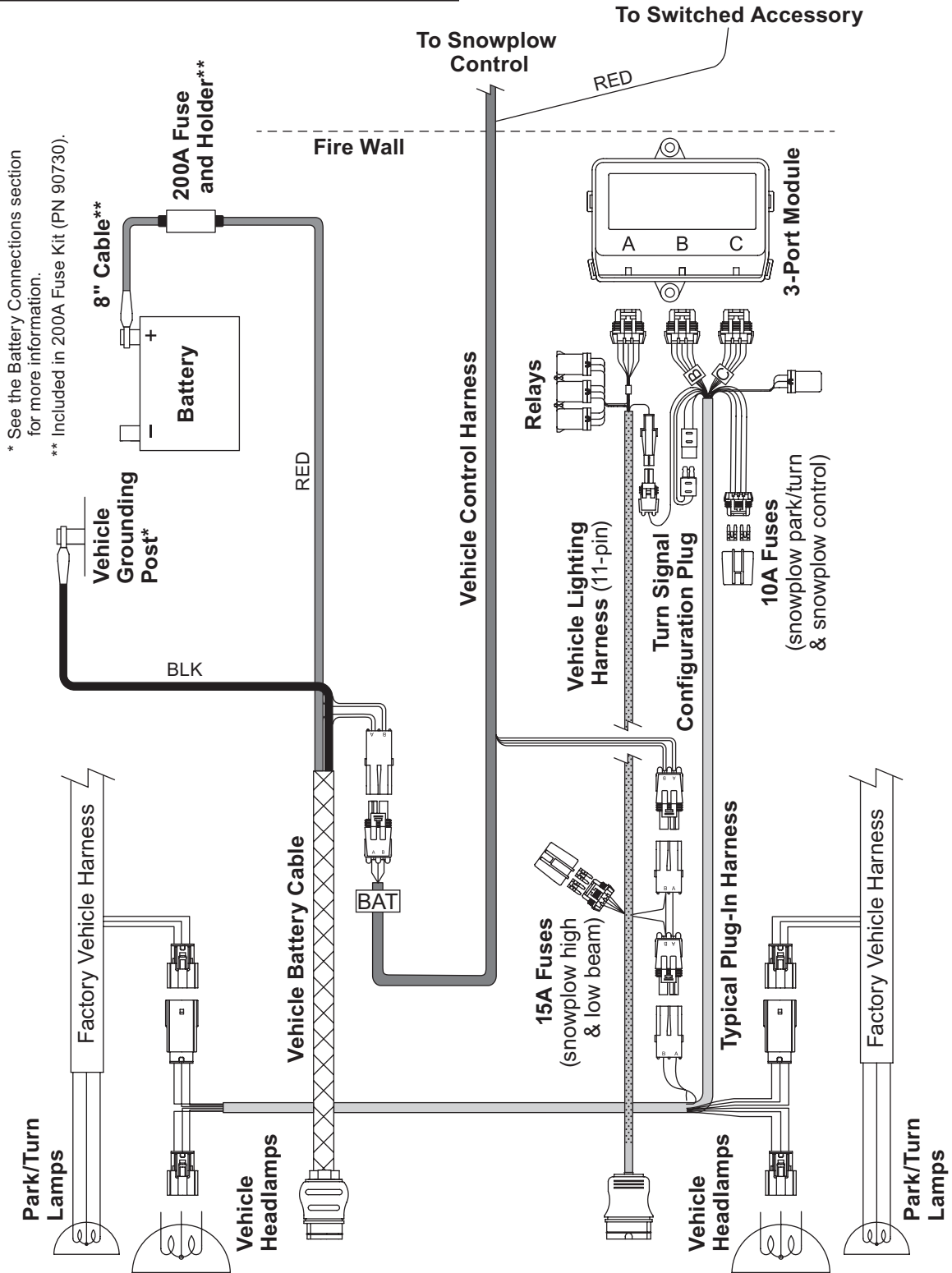

* See the Battery Connections section for more information.
 ** Included in 200A Fuse Kit (PN 90730).

TYPICAL 2-PLUG, 3-PORT MODULE HALOGEN VEHICLE LIGHTING SYSTEM DIAGRAM

NOTE: On 2-plug electrical systems, plug covers shall be used whenever snowplow is disconnected.

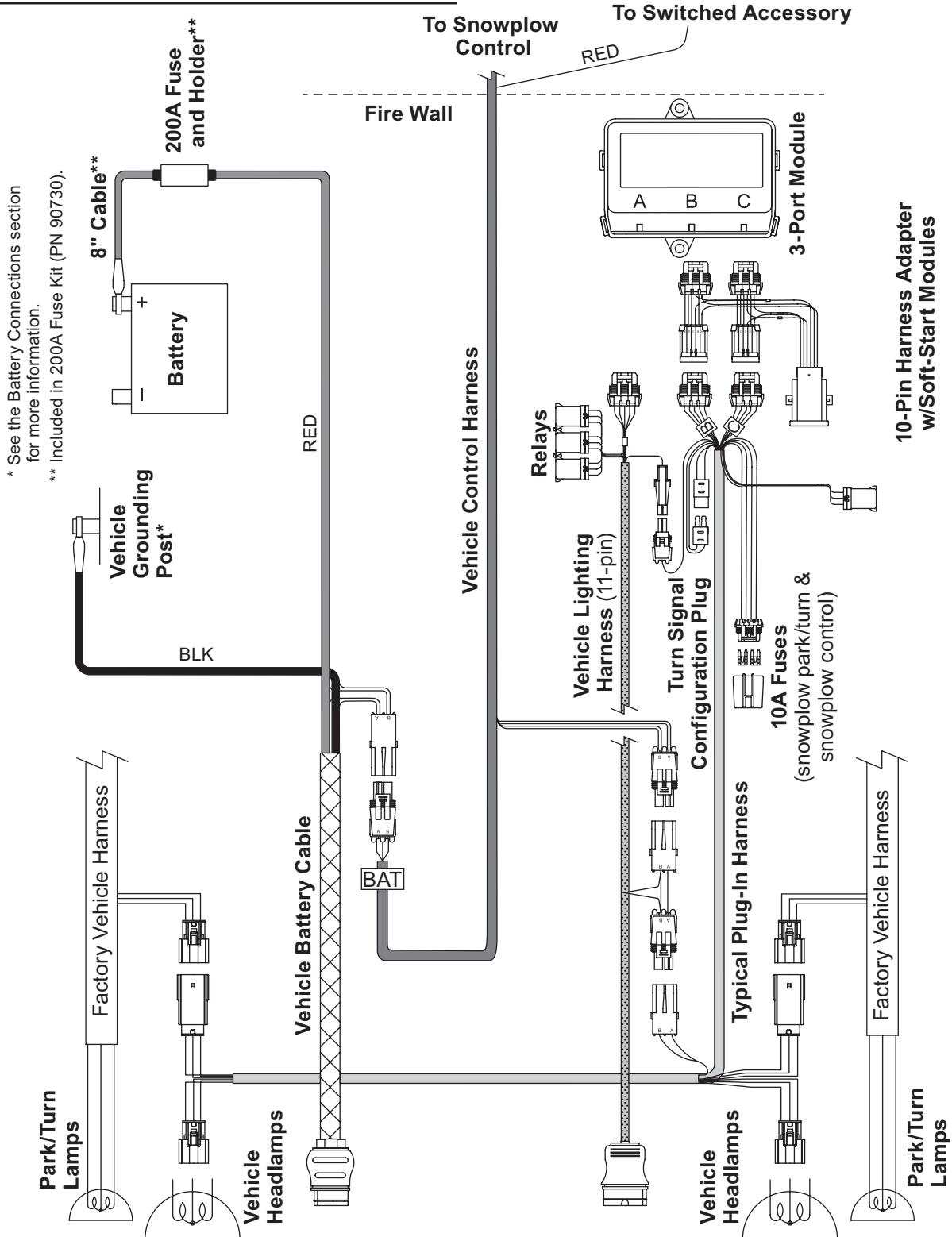

* See the Battery Connections section for more information.
 ** Included in 200A Fuse Kit (PN 90730).

INSTALLATION INSTRUCTIONS

Isolation Module Mounting

⚠ CAUTION

Before installing self-drilling screws or drilling mounting holes, check the selected mounting area for any wires, hoses, or other obstructions.

Isolation modules are sold separately. Check the online selection system for the correct module for your vehicle.

Locate a flat surface within the engine compartment of the vehicle for mounting the isolation module (**on the driver's side, if possible**). The fire wall, fender well, or radiator shroud are possible mounting locations. If a suitable flat surface is not accessible, cable tie the isolation module to existing brackets or harnessing.

Reclosable fastener strips and/or cable ties are supplied for mounting the isolation module, but self-drilling screws can also be used. When using reclosable fastener strips, the mounting surface must be free of dirt and grease.

Isolation Module (bottom view)

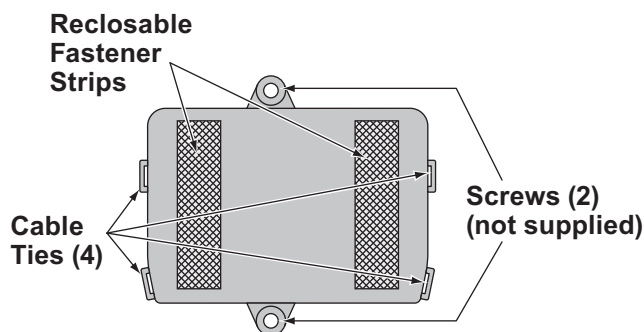

Vehicle Battery Cable Installation

⚠ CAUTION

Batteries normally produce explosive gases, which can cause personal injury. Therefore, do not allow flames, sparks, or lit tobacco to come near the battery. When charging or working near a battery, always cover your face and protect your eyes, and also provide ventilation.

- Batteries contain sulfuric acid, which burns skin, eyes, and clothing.
- Disconnect the battery before removing or replacing any electrical components.

NOTE: Fuse holder and fuse are to be installed between the POSITIVE (+) vehicle battery terminal and the end of the supplied snowplow vehicle battery cable assembly.

NOTE: When instructed, make all snowplow battery cable connections to the auxiliary battery, if vehicle is so equipped.

NOTE: Use dielectric grease on all electrical connections to prevent corrosion. Fill receptacles and lightly coat ring terminals before assembly.

1. Turn OFF the vehicle ignition.
2. Disconnect both the NEGATIVE (-) and the POSITIVE (+) battery cables.
3. Route the supplied vehicle battery cable from the grille or bumper to the battery, avoiding any sharp edges and hot or moving parts. Cable tie only the end section closest to the grille.

4. Remove the fuse holder cover, loosen and remove the fuse holder nuts and lock washers. Install a 200A fuse into the fuse holder.
5. Attach one end of the supplied 8" cable to the fuse holder so that the ring terminal is on top of the fuse. Replace the lock washer and nut on this terminal and hand tighten the nut.
6. Attach the red lead from the vehicle battery cable to the second fuse holder terminal, placing the cable ring terminal on top of the fuse lead. Replace the lock washer and nut on this terminal and hand tighten the nut.
7. Torque the fuse holder nuts to 106–159 in-lb and snap the fuse holder cover into place.
8. Route the 8" cable from the fuse holder to the POSITIVE (+) battery terminal. *Do not connect at this time.*
9. Route the black wire from the vehicle battery cable to the vehicle NEGATIVE (–) chassis grounding stud. *Do not connect at this time.*

The 4-position connector from the vehicle battery cable will connect to the mating connector (labeled "BAT") on the end of the vehicle control harness.

NOTE: Do NOT route the black vehicle battery cable wire to the NEGATIVE (–) battery post. See the Battery Connections section on page 14 for more information.

Vehicle Lighting and Vehicle Control Harness Installation

For Halogen plow light installation, proceed with the following instructions.

For LED plow light installation, install the vehicle control harness as instructed, but DO NOT install the supplied vehicle lighting harness. Instead, refer to the LED Installation Instructions on page 10.

1. Route both harnesses around or through the radiator bulkhead to the isolation module.
2. Connect the 4-position connector from the vehicle lighting harness to the matching 4-position connector from the vehicle control harness.
3. Connect the vehicle lighting harness to position "A" on the isolation module.
4. Route the end of the vehicle control harness with the white 4-pin connector to the fire wall.

Connect the black 4-position connector (labeled "BAT") from the end of the vehicle control harness to the 4-position connector from the vehicle battery cable. *Do not cable tie the harness at this time.*

⚠ CAUTION

Before installing self-drilling screws or drilling mounting holes, check the selected mounting area for any wires, hoses, or other obstructions.

5. On the driver's side, locate an existing hole through the fire wall for the vehicle control harness. If access through the fire wall does not exist, drill a 5/8" hole through the fire wall in a convenient location away from sharp edges and hot or moving parts.

6. Push the braided harness breakout with the cab control connector through the fire wall hole into the cab. Use a grommet, existing plug cover, or proper anti-chafing material to protect the harness where it passes through the fire wall. Route the harness to the selected control mounting location.

To mount the control, follow the instructions supplied with the control.

7. Locate an accessory wire controlled by the ignition switch. Acceptable accessory wires show +12V when the ignition switch is ON, and 0V when it is OFF.
8. Route the red "ACC" wire from the vehicle control harness to this location and trim away excess length.
9. Following the recommended splicing procedure given at the end of this document, splice the red "ACC" wire into the switched accessory wire using the supplied parallel splices and heatshrink tubing.

NOTE: Cable tie the control harness and accessory tap away from the brake, clutch, gas, or parking brake pedals, and any moving parts.

Plug Cover Installation

Stretch the rectangular opening of the supplied plug cover over the end of the vehicle battery cable. Close the plug cover over the molded plug whenever the snowplow is not in use.

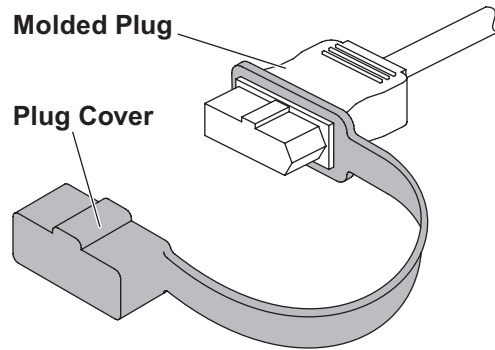

PLUG-IN HARNESS INSTALLATION

LED Vehicle Lighting System

1. Remove the headlamp or headlamp housing connectors. Connect the plug-in harness to the mating connectors removed from the headlamps or headlamp housings. Connect the plug-in harness to the mating connections at the headlamps or headlamp housings. Refer to the system diagram.
2. Route the plug-in harness to the isolation module. Connect the plug-in harness to the module by matching harness connector B with module port B and harness connector C with module port C.
3. Connect the 4-position connector on the vehicle lighting harness to the matching 4-position connector on the plug-in harness.
4. Connect the single-wire connector from the vehicle lighting harness to the single-wire connector from the plug-in harness.

Halogen Vehicle Lighting System

1. Remove the headlamp or headlamp housing connectors. Connect the plug-in harness to the mating connectors removed from the headlamps or headlamp housings. Connect the plug-in harness to the mating connections at the headlamps or headlamp housings.

Route the plug-in harness to the 3-port isolation module. Connect the plug-in harness to the 10-pin harness adapter, matching harness connectors with adapter ports: B to B and C to C. Connect the adapter to the module, matching adapter connectors with module ports: B to B and C to C.

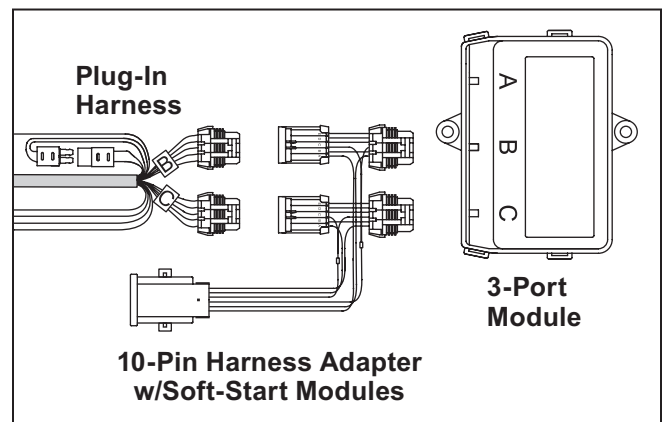

2. Connect the black 4-position connector from the middle of the vehicle control harness to the 4-position connector from the plug-in harness.
3. Mount the soft-start modules in an area that receives good airflow, such as the cavity between the grille and the radiator.

Turn Signal Configuration Plug

⚠ WARNING

If the turn signal configuration plug is mated incorrectly, the turn signals will be reversed between the vehicle and the snowplow.

1. Mate the turn signal configuration plug located on the plug-in harness.

If the isolation module is installed on the driver's side, mate the plug so that the wire colors match (green to green and blue to blue).

If the module is installed on the passenger's side, mate the plug so that the wire colors are opposite (green to blue).

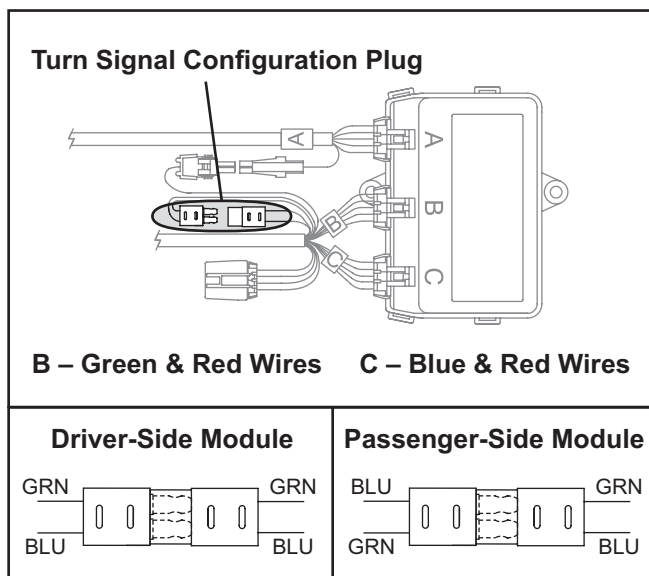

LED INSTALLATION INSTRUCTIONS

Headlamp Control Module (HCM) Mounting

Locate a flat surface within the engine compartment of the vehicle near the isolation module. If a suitable flat surface is not accessible, cable tie the HCM to existing brackets or harnessing.

Mount the HCM so that the harness connections are wire side down.

NOTE: If possible, mount the HCM in an area that is protected from road splash.

Reclosable fastener strips and/or cable ties are supplied for mounting the HCM. When using reclosable fastener strips, the mounting surface must be free of dirt and grease.

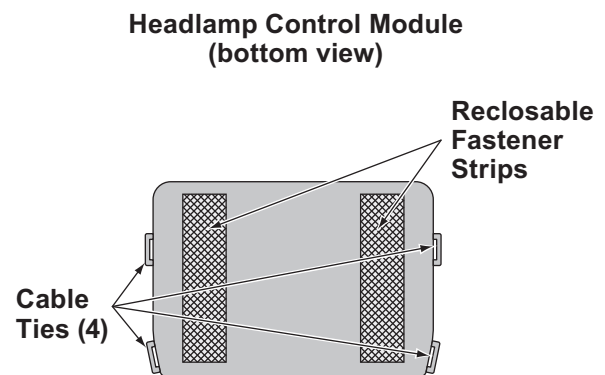

HCM Vehicle Battery Cable Installation

⚠ CAUTION

Batteries normally produce explosive gases, which can cause personal injury. Therefore, do not allow flames, sparks, or lit tobacco to come near the battery. When charging or working near a battery, always cover your face and protect your eyes, and also provide ventilation.

- Batteries contain sulfuric acid, which burns skin, eyes, and clothing.
- Disconnect the battery before removing or replacing any electrical components.

NOTE: When instructed, make all snowplow battery cable connections to the auxiliary battery, if vehicle is so equipped.

NOTE: Use dielectric grease on all electrical connections to prevent corrosion. Fill receptacles and lightly coat ring terminals before assembly.

1. Turn OFF the vehicle ignition.
2. Disconnect both the NEGATIVE (-) and the POSITIVE (+) battery cables from the vehicle battery.
3. Route the supplied HCM vehicle battery cable from the battery to the 2-position mating connector on the HCM vehicle lighting harness, avoiding any sharp edges and hot or moving parts.

HCM Vehicle Lighting Harness Installation

1. Route harnesses around or through the radiator bulkhead to the HCM.
2. Make the following connections:
 - a. 2-position connector from the vehicle lighting harness to the matching 2-position connector from the vehicle cable assembly
 - b. Vehicle lighting harness to position "Y" on the HCM
 - c. Single-pin connector from the plug-in harness assembly to the single-pin connector on the vehicle lighting harness.
3. Route the red wire from the vehicle lighting harness to the stud on the HCM.
4. Remove the protective plastic domed nut and the top brass nut from the HCM stud. Install the red wire ring terminal on stud and remaining brass nut. Reinstall the top brass nut and tighten to 25.9 in-lb. Reinstall the protective plastic domed nut. (See illustration below.)

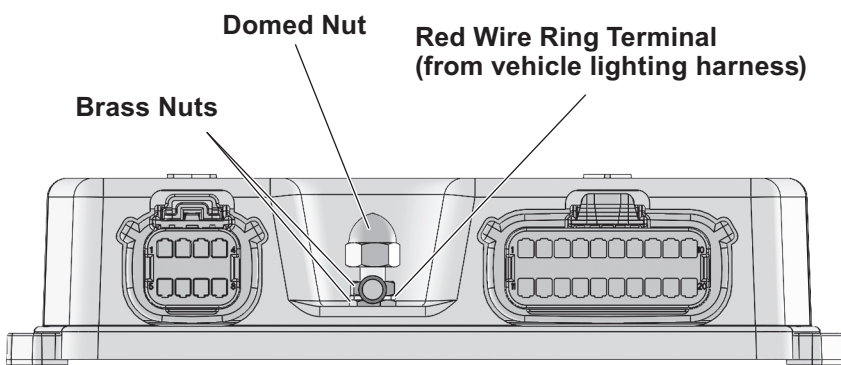

Headlamp Control Module (HCM)

TYPICAL LED PLOW LIGHT, HEADLAMP CONTROL MODULE (HCM), AND HARNESS DIAGRAM

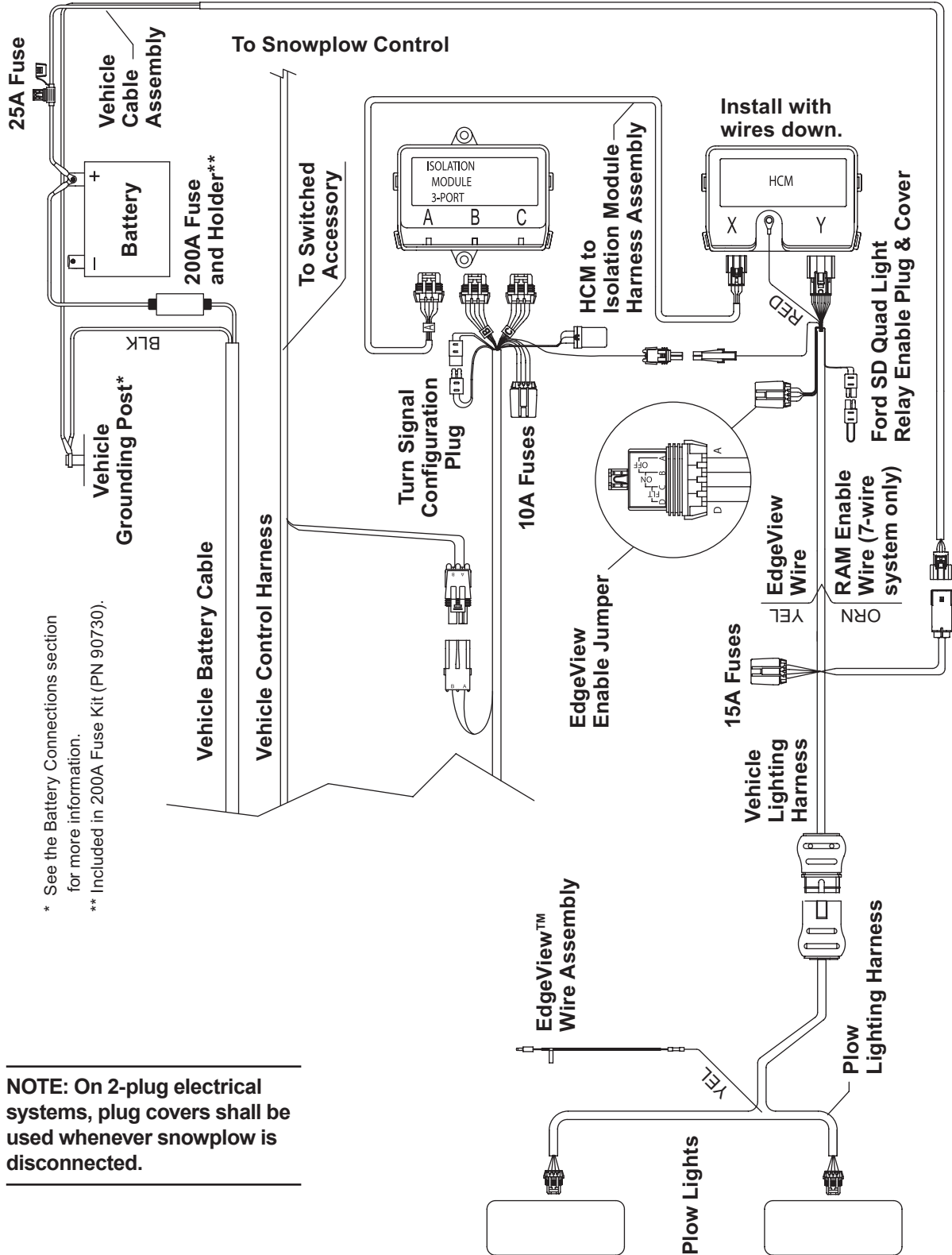

* See the Battery Connections section for more information.
 ** Included in 200A Fuse Kit (PN 90730).

NOTE: On 2-plug electrical systems, plug covers shall be used whenever snowplow is disconnected.

PLUG COVER INSTALLATION

Stretch the rectangular opening of the plug cover strap over the end of the HCM vehicle lighting harness. Place the plug cover over the molded plug whenever the snowplow is not in use.

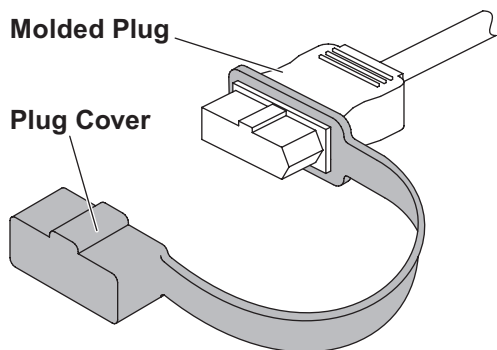

HCM TO ISOLATION MODULE HARNESS INSTALLATION

1. Make the following connections:
 - 10-pin connector to port A of the isolation module
 - 8-position connector to port X of the HCM.
2. Cable tie harnesses as needed, away from any sharp, hot, or moving parts.

BATTERY CONNECTIONS

NOTE: Use cable ties to secure cable assemblies and control and lighting harnesses away from any sharp edges and hot or moving parts.

NOTE: Follow OEM battery cable connection recommendations when attaching to the battery.

NOTE: Do NOT connect ground wires directly to the NEGATIVE (-) battery post. Direct connections to the NEGATIVE (-) battery post will cause the charging system to malfunction and shorten battery life. The NEGATIVE (-) cables should be connected to the vehicle grounding stud.

1. Make the following attachments to the POSITIVE (+) battery terminal:
 - a. POSITIVE (+) OEM cable assembly
 - b. Red 8" cable from fuse holder
 - c. Red cable from headlamp control module power cable.
2. Make the following attachments to the vehicle grounding stud:
 - a. NEGATIVE (-) OEM cable assembly
 - b. Black vehicle battery cable
 - c. Black cable from headlamp control module power cable.

CHANGING BLADE-EDGE ILLUMINATION MODE

On snowplows equipped with LED headlamps, the EdgeView™ technology feature offers three modes for blade-edge illumination. The factory default setting is ON.

To change the blade-edge illumination mode, remove the cover from the fuse holder located near the "Y" port of the headlamp control module installed in the vehicle engine compartment.

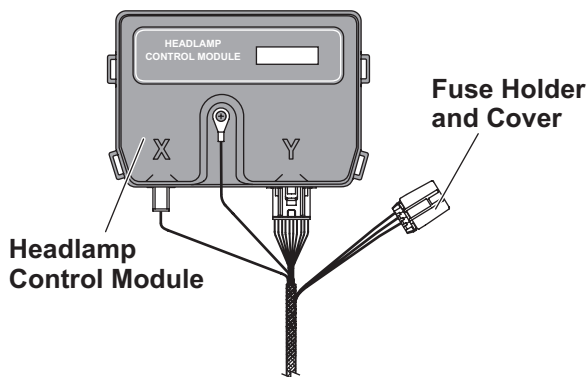

Remove the jumper fuse from the fuse holder and re-insert it in the desired mode position as shown below. Replace the fuse holder cover.

Default – ON:
Blade edge lights illuminate when plow has power.

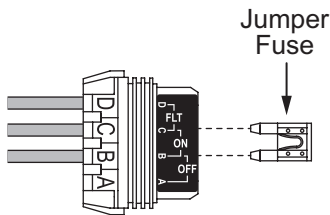

FLT: Blade edge lights illuminate when blade is in FLOAT mode.

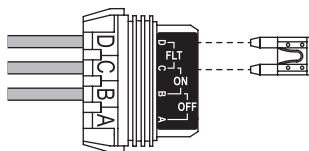

OFF: Blade edge lights disabled.

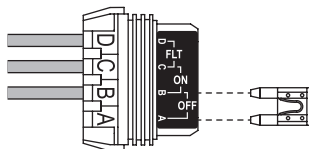

PLOW-SIDE EdgeView LIGHTING CONNECTIONS

The EdgeView Float (FLT) mode activation function will require a second plow-side electrical connection.

1. On the plow-side LED lighting harness, locate the yellow wire cable tied to the body of the harness near the "Y" section.
2. Strip the end of the yellow wire and insert stripped wire end into the pre-installed insulated butt connector on the supplied EdgeView wire assembly.
3. Crimp the connection and heat seal the insulated splice.
4. Remove the snowplow hydraulic unit cover. Route the EdgeView wire assembly along the snowplow structure to the snowplow hydraulic unit, and cable tie wires as needed.
5. Locate the solenoid on the snowplow hydraulic unit that is activated during the snowplow Lower/Float function. Refer to the Mechanic's Guide or snowplow manufacturer's website for further information.
6. Plug the bullet terminal on the end of the supplied EdgeView wire assembly into the receptacle on the corresponding solenoid wire. If a receptacle is not found on the correct solenoid wire, remove the bullet terminal from the EdgeView wire assembly and splice the end of the EdgeView wire into the correct solenoid wire.
7. Cable tie extra wire length to the snowplow assembly and reinstall the hydraulic unit covers.

NOTE: EdgeView light will turn ON or OFF approximately 5 seconds after EdgeView Mode is activated or canceled.

RECOMMENDED SPLICING PROCEDURE

1. Locate the wire to be spliced into.
 2. Cut the wire at least 1-1/2" from any other splice, connector, or terminal. If wires are covered by tubing or braid, remove enough of it to achieve the minimum clearance required.
 3. Strip away 5/16" of insulation from the ends of the wires to be spliced.
 4. Slide two wires into one end of the supplied parallel splice.
 5. Place a 1-1/4" length of 3/16" heatshrink tubing over the remaining wire to be spliced.
 6. Insert the wire into the open end of the splice and crimp using an appropriate crimp tool. One or two crimps may be necessary to ensure a good connection. No wire strands should be visible outside of the splice.
 7. Preheat a soldering tool for at least one minute to help promote even solder flow.
 8. Apply heat to the splice. Avoid heating too close to the insulation. Apply solder to the wires, using just enough solder to produce an even flow through the splice. **Use rosin core solder ONLY. Do not use acid core solder.**
- NOTE: Avoid using an excessive amount of solder, as it can result in wicking. Wicking occurs when solder travels up the wire core. This may cause the wire to become stiff or brittle, which could lead to a broken or open circuit.**
9. Check the circuits for continuity.
 10. Cover the splice with heatshrink tubing. The tubing should extend beyond the splice on both sides.
 11. Using a hot air source, starting in the center and working out to either side, apply heat until the tubing recovers and glue can be seen around the edges. Allow the tubing to cool before handling.

NOTE: The splices supplied will accommodate 18-gauge wires as shown. For larger gauge wires, cut the wire, strip the ends 3/8" to 1/2", and twist together. Apply solder to the splice and cover with heatshrink tubing.

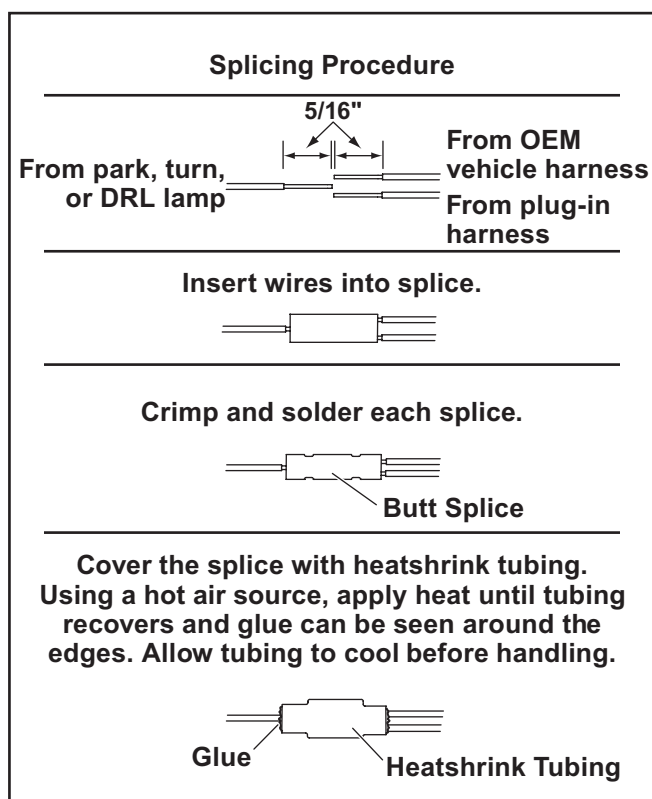

Copyright © 2020 Douglas Dynamics, LLC. All rights reserved. This material may not be reproduced or copied, in whole or in part, in any printed, mechanical, electronic, film, or other distribution and storage media, without the written consent of the company. Authorization to photocopy items for internal or personal use by the company's outlets or snowplow owner is granted.

The company reserves the right under its product improvement policy to change construction or design details and furnish equipment when so altered without reference to illustrations or specifications used. This equipment manufacturer or the vehicle manufacturer may require or recommend optional equipment for snow removal. Do not exceed vehicle ratings with a snowplow. The company offers a limited warranty for all snowplows and accessories. See separately printed page for this important information. The following is an unregistered (™) trademark of Douglas Dynamics, LLC: EdgeView™.

Printed in U.S.A.
