



Meyer Path Pro™ Moldboard

Model PP-50", PP-60" & PP-72"

ZTR Universal Mounting Instruction



Parts List

Item	PP-50" Part No.	PP-60" Part No.	PP-72" Part No.	Qty.	Description
	29010	29110	29210		ZTR Path Pro Kit
1	09344	09363	09419	1	• Path Pro™ Moldboard Assy
2	09337	09335	09418	1	•• Cutting Edge
3	21943	21943	21943	6	•• Bolt C 1/2-13 x 1-3/4" Gr. 5
4	20307	20307	20307	6	•• Locknut 1/2-13
	16617	16617	16617		• Path Pro™ ZTR PAF Carton
5	13243	13243	13243	1	•• Push Frame PP
6	13286	13286	13286	2	•• Trip Spring PP
7	13447	13447	13447	1	•• Horizontal Support
8	13348	13348	13348	1	•• Pivot Pin Handle PP
9	13453	13453	13453	1	•• ZTR Universal Mounting
	08331	08331	08331		•• Carton ZTR
10	07665	07665	07665	1	••• Auto Angle Ram PP
11	13250	13250	13250	1	••• Pivot Bar PP
12	13468	13468	13468	2	••• Strut Support
	08900	08900	08900		••• Hardware Bag Plow
13	13350	13350	13350	1	•••• Spring
14	20147	20147	20147	1	•••• Bolt H 5/8-11 x 3-1/2" Gr. 5
15	20305	20305	20305	2	•••• Locknut 3/8-16
16	20309	20309	20309	1	•••• Locknut 5/8-11
17	20353	20353	20353	2	•••• Flatwasher 3/8"
18	20364	20364	20364	1	•••• Flatwasher 3/8"
19	20385	20385	20385	1	•••• Cotter Pin 1/8 x 1-1/4"
20	20526	20526	20526	2	•••• Finish Nut 3/8-16
21	22845	22845	22845	4	•••• Hair Pin Cotter 1/8"
22	22850	22850	22850	2	•••• Clevis Pin 1/4 x 1-1/4"
23	22851	22851	22851	2	•••• Eyebolt 3/8-16 x 4"
24	22852	22852	22852	2	•••• Clevis Pin 3/8 x 2-1/4"
25	22880	22880	22880	1	•••• Rubber Lift Stop
	08349	08349	08349		•••• Hardware Bag ZTR Mount
26	13448	13448	13448	2	•••• Adjustable Support
27	13454	13454	13454	14	•••• Bolt Plate
28	20097	20097	20097	2	•••• Bolt H 1/2-13 x 2" Gr. 5
29	20307	20307	20307	4	•••• Locknut 1/2-13
30	20355	20355	20355	16	•••• Flatwasher 1/2"
31	20353	20353	20353	12	•••• Flatwasher 3/8"
32	20305	20305	20305	12	•••• Locknut 3/8-16
33	20049	20049	20049	2	•••• Bolt H 3/8-16 x 1" Gr. 5
34	22845	22845	22845	2	•••• Hair Pin 1/8 x 1-15/16"
35	22871	22871	22871	2	•••• Clevis Pin 3/8 x 1-1/2"
36	21540	21540	21540	2	•••• Chain 3/8 x 8.25
37	20100	20100	20100	2	•••• Bolt H 1/2-13 x 2-3/4" Gr. 5
38	22119	22119	22119	8	•••• Bolt H 3/8-16 x 3-1/4" Gr. 5
39	20051	20051	20051	4	•••• Bolt H 3/8-16 x 1-1/2" Gr. 2
40	22923	22923	22923	12	•••• Bolt H 3/8-16 x 3-3/4 Gr. 5
41	20027	20027	20027	2	•••• Bolt H 5/16-18 x 1" Gr. 2
42	20313	20313	20313	2	•••• Locknut 5/16-18
43	20096	20096	20096	2	•••• Bolt H 1/2-13 x 1-3/4" Gr. 5
44	20526	20526	20526	2	•••• Finnish Nut 3/8-16
45	20528	20528	20528	2	•••• Finnish Nut 1/2-13
	08353	08353	08353		•••• Hardware Bag Exmark
46	22938	22938	22938	2	•••• U-Bolt
47	20352	20352	20352	4	•••• Flatwasher 5/16"
48	20304	20304	20304	4	•••• Locknut 5/16-18

Parts indented are included in the assembly under which they are indented.

Meyer Products LLC reserves the right, under its continuing product improvement program, to change construction or design details, specifications and prices without notice or without incurring any obligation.

TORQUE CHART FOOT

Bolt Nut Size	Gr. 2 	Gr. 5 	Gr. 8 
1/4 - 20	4 - 5		
5/16 - 18	9 - 11		
3/8 - 16	17 - 20	26 - 29	
7/16 - 14		42 - 46	60 - 66
1/2 - 13		64 - 72	90 - 100
5/8 - 11		127 - 141	179 - 198

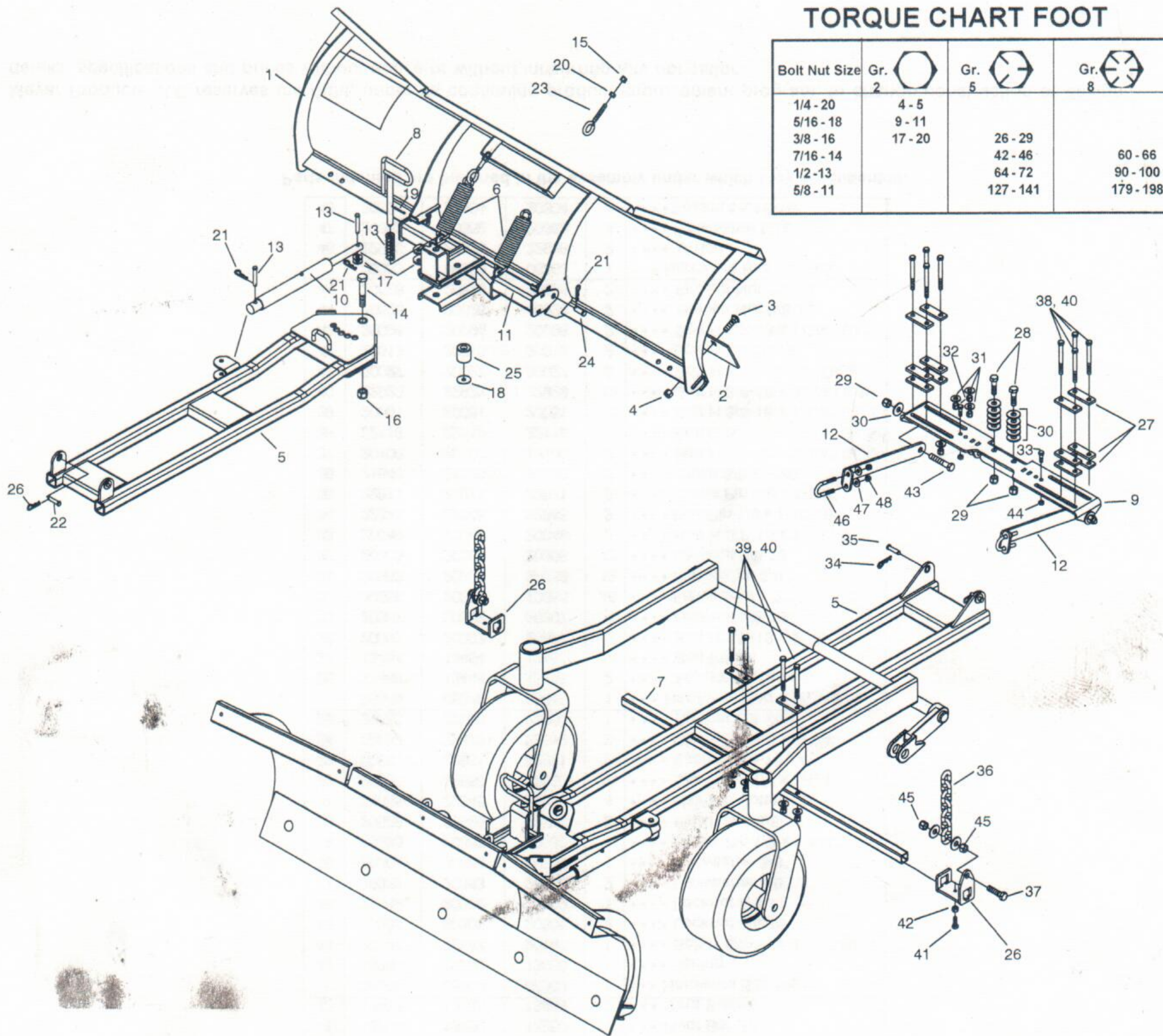

ZTR MOUNT ASSEMBLY INSTRUCTIONS

- A. Remove mower deck from ZTR.
- B. Attach ZTR universal mounting bracket to ZTR frame using hardware provided. See illustration above. All hardware will not be used since the mount is designed for many ZTR brands. See next page for pictures.
- C. ZTR lift mechanism is used to raise and lower plow. Spring tension on lift mechanism may need adjusted for the snow plow.
- D. Tighten all bolts to proper torque using torque chart below.
- E. See owners manual for plow assembly and attachment.

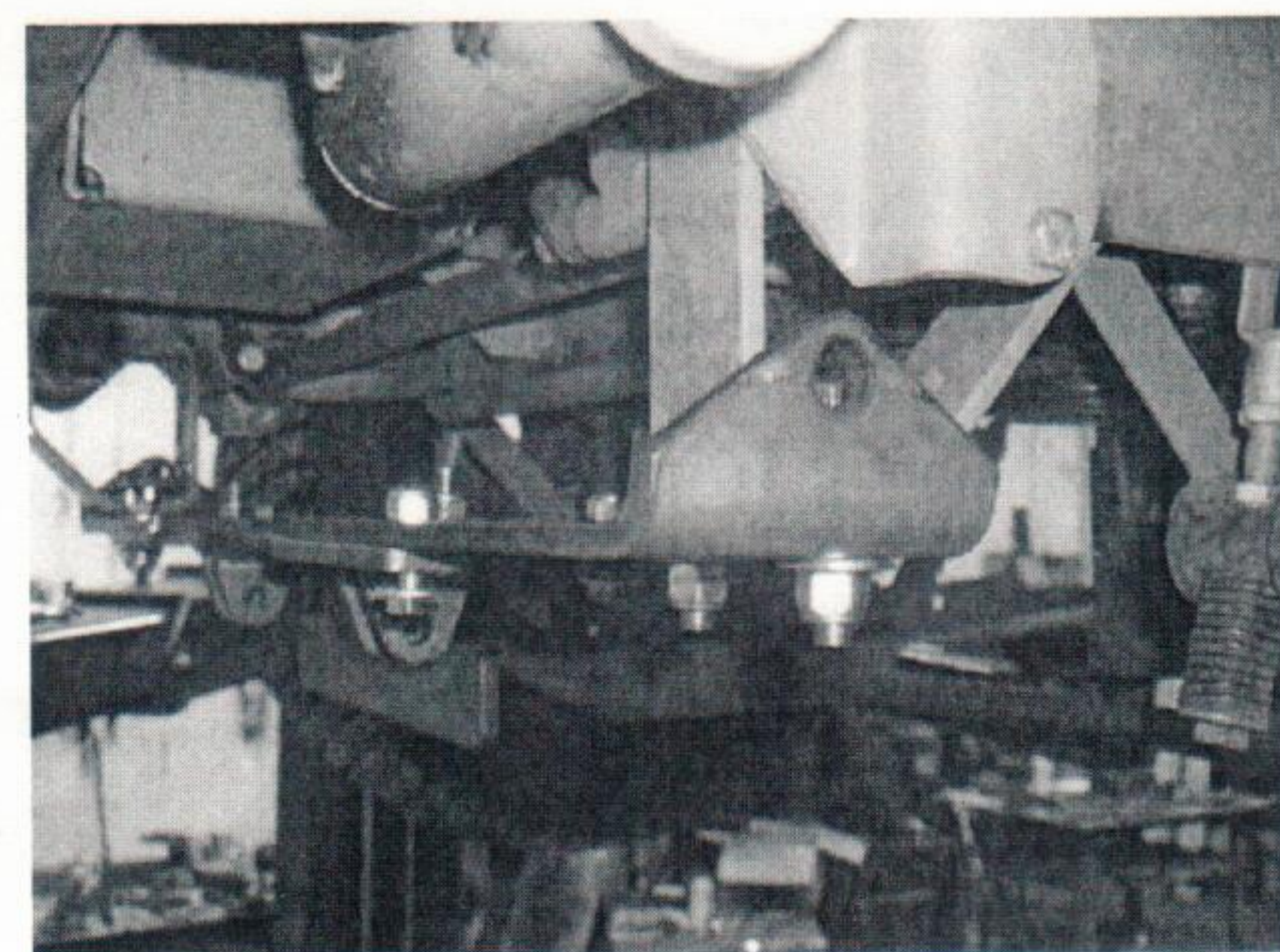
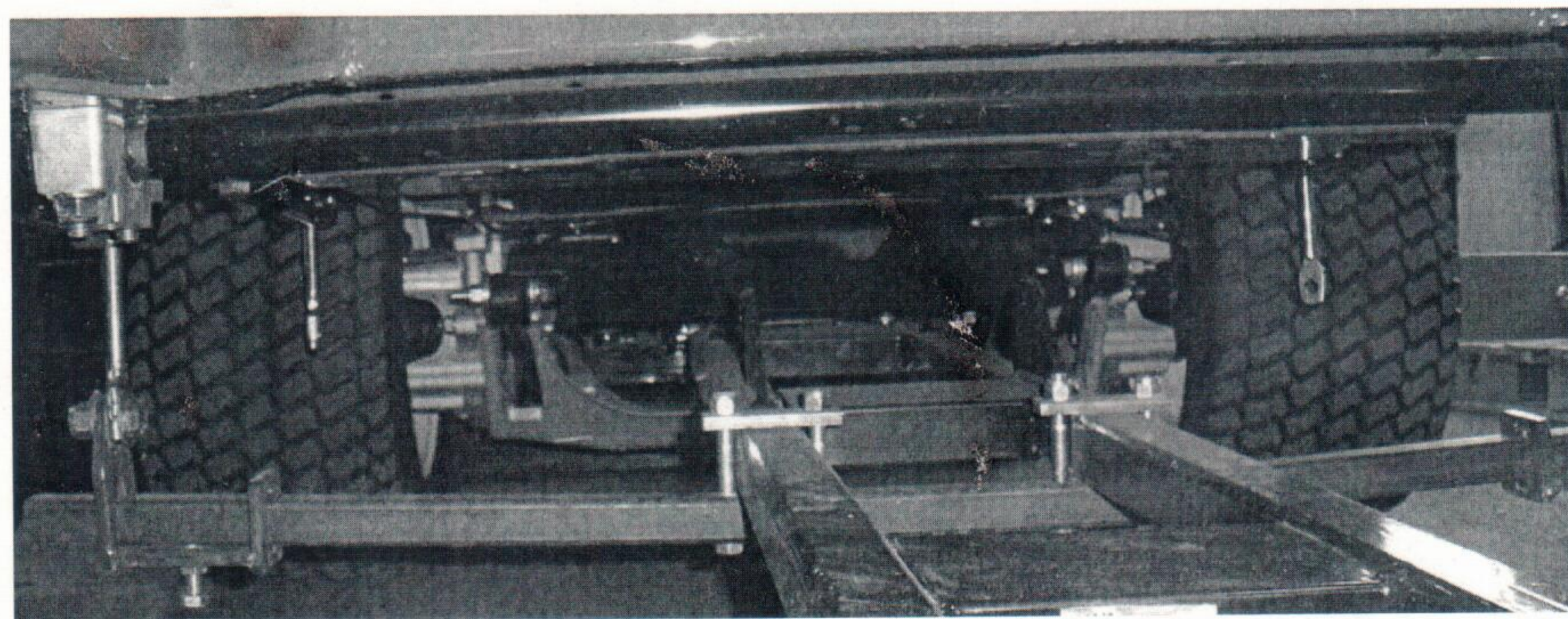
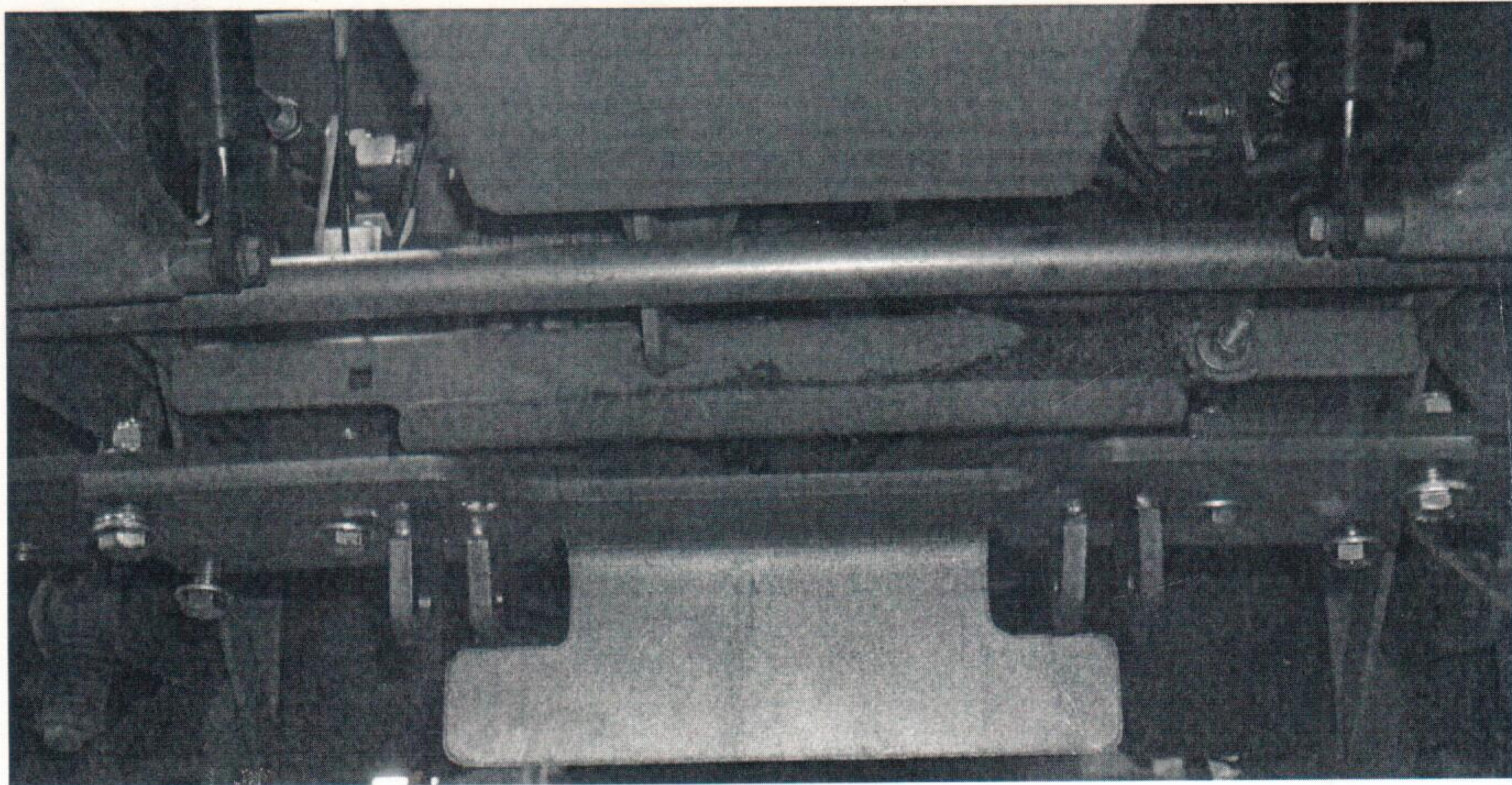

© 2012 Printed in the U.S.A.

Meyer

Meyer Products LLC
18513 Euclid Ave. • Cleveland, Ohio 44112-1084
Phone 486-1313 (Area Code 216)
www.meyerproducts.com • email info@meyerproducts.com