

Installation Instructions

⚠ DANGER

Vehicle engines contain moving parts and can become extremely hot, capable of causing severe burns and serious bodily harm.

Shut off the engine and allow it sufficient time to cool down before installing this kit.

⚠ DANGER

Vehicle batteries can cause dangerous electrical shocks that could lead to severe burns or death.

Disconnect your battery before installing this kit.

Determine the left and right sides of the machine from the normal operating position.

1. Disconnect the wire harness plug from the back of the left vehicle headlight.
2. Locate the end of the headlight adapter harness with 2 black plugs, and connect the square plug to the back of the left vehicle headlight.
3. Connect the black rubber female connector from the headlight adapter harness to the blue plug on the plow wire harness.
4. Connect the blue rounded plug on the opposite end of the headlight adapter harness to the black plug on the plow wire harness.
5. Connect the remaining black plug on the headlight adapter harness to the previously disconnected plug on the vehicle wire harness.
6. Connect the fused eyelet on the headlight adapter to a battery power source.
7. Mount the headlight adapter relay to the vehicle in an easily accessible location.

Note: Ensure that the relay is mounted upright.

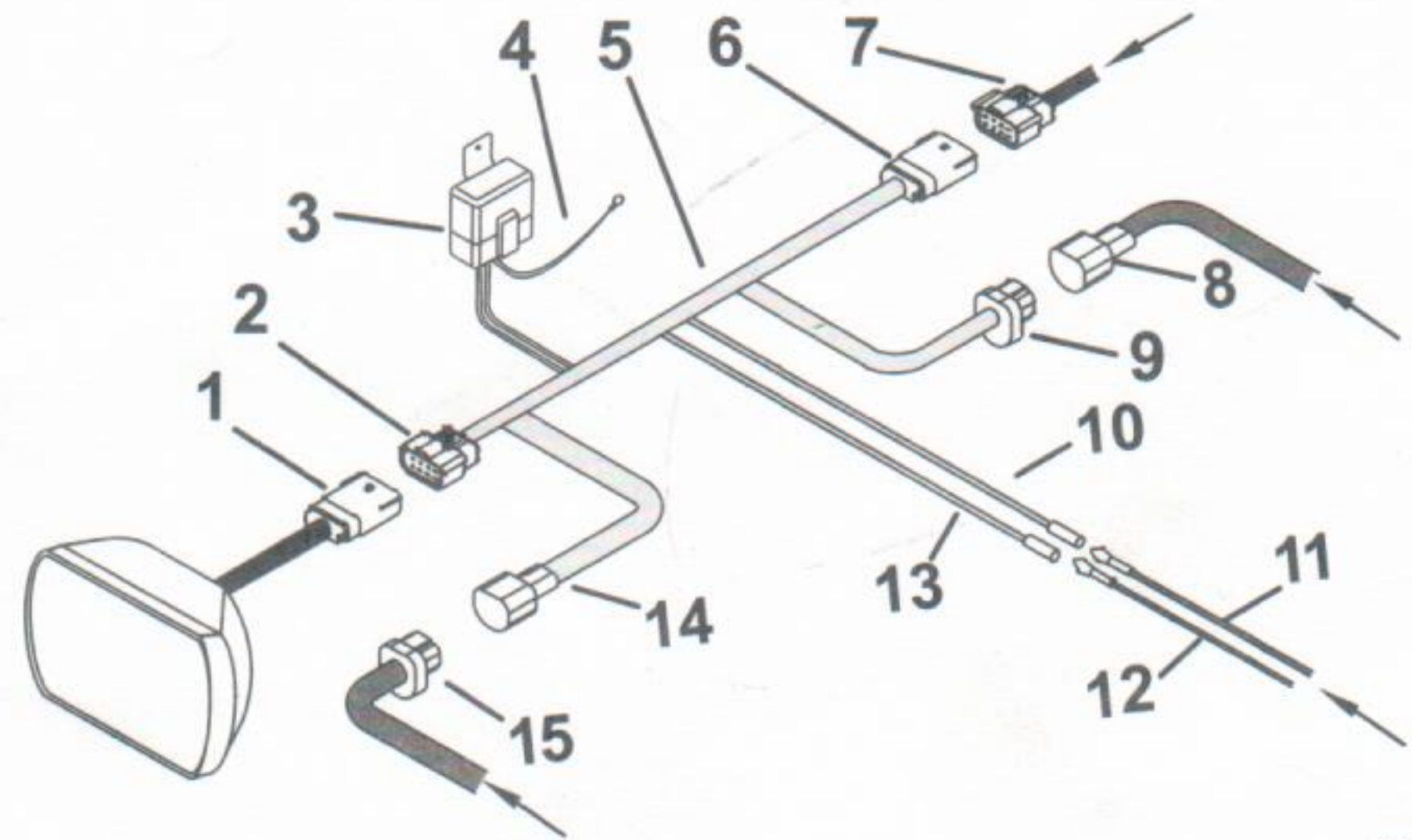

Figure 1

g325164

- | | |
|---|---|
| 1. Vehicle headlight plug | 9. Blue rounded plug |
| 2. Black square headlight adapter plug (female) | 10. Violet connector (headlight adapter harness) |
| 3. Relay | 11. Violet/Pink connector (headlight adapter harness) |
| 4. Fused eyelet | 12. Yellow connector (plow harness) |
| 5. Headlight adapter harness | 13. Yellow connector (headlight adapter harness) |
| 6. Black square plug (male) | 14. Black plug (headlight adapter harness) |
| 7. Vehicle harness | 15. Blue plug (plow harness) |
| 8. Black plug (plow harness) | |

8. Connect the yellow bullet plug from the headlight adapter harness to the yellow bullet plug on the left side plow wire harness.
9. Connect the violet bullet plug from the plow wire harness to the violet connector on the left side plow wire harness.
10. Repeat steps 1 through 8 on the right vehicle headlight.
11. Connect the violet bullet plug from the headlight adapter harness to the pink bullet plug on the right side plow wire harness.
12. Grease, tuck, and secure the yellow bullet plug from the headlight adapter harness.

Note: You will not use this connector.

13. Locate the vehicle option connector and align it in the standard orientation as shown below:

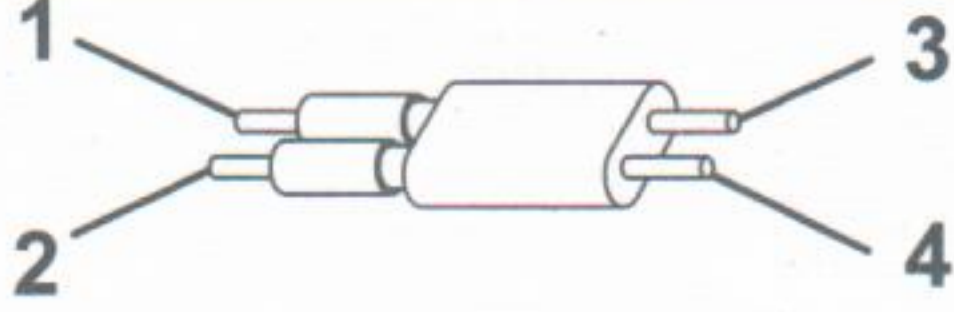
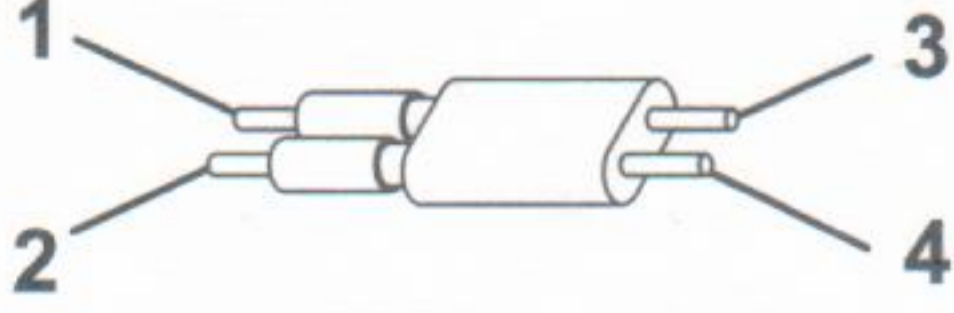

Orientation	Wire Colors
Standard orientation	 <p data-bbox="414 308 946 405"> 1. Red/yellow 3. Red/yellow 2. White/yellow 4. White/yellow </p>
Reverse orientation	 <p data-bbox="414 602 946 699"> 1. White/yellow 3. Red/yellow 2. Red/yellow 4. White/yellow </p>