



# **Minute<sup>2</sup> Mount<sup>®</sup>**

**SYSTEM**

## **MOUNT KIT**

**Dodge 4500/5500**

**2008–12**

**Sterling Bullet 45/55**

**2008–12**

### **Installation Instructions**

**⚠ CAUTION**

Read this document before installing the snowplow.

**⚠ CAUTION**

See your FISHER<sup>®</sup> outlet/Web site for specific vehicle application recommendations before installation. The Kit Selection Guide has specific vehicle and snowplow requirements.

**SAFETY DEFINITIONS**

**⚠ WARNING**

Indicates a potentially hazardous situation that, if not avoided, could result in death or serious personal injury.

**⚠ CAUTION**

Indicates a potentially hazardous situation that, if not avoided, may result in minor or moderate injury. It may also be used to alert against unsafe practices.

**NOTE:** Indicates a situation or action that can lead to damage to your snowplow and vehicle or other property. Other useful information can also be described.

**WARNING/CAUTION AND INSTRUCTION LABELS**

Become familiar with and inform users about the warning labels on the back of the blade and the instruction label on the headgear.

**NOTE:** If labels are missing or cannot be read, see your sales outlet.

Warning/Caution Label

**⚠ WARNING**

 Lower blade when vehicle is parked.

 Do not exceed GVWR or GAWR including blade and ballast.

---

**⚠ CAUTION**

 Read Owner's Manual before operating or servicing snowplow.

 Transport speed should not exceed 45 mph (72 km/h). Further reduce speed under adverse travel conditions.

 Plowing speed should not exceed 10 mph (16 km/h).

 See your sales outlet/Web site for specific vehicle application recommendations. 59903

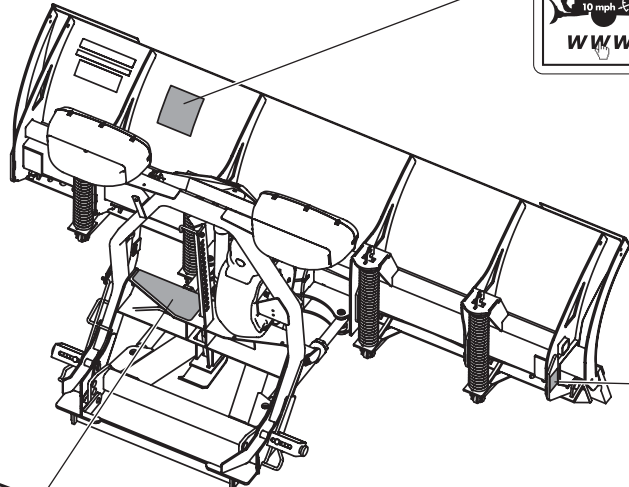

Multiple Pinch Points Label

**⚠ WARNING**



**Multiple Pinch Points**

**XLSTM™ Blades Only (both sides)**

Instruction Label

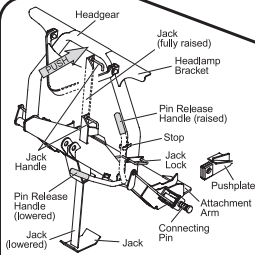

**ATTACH**

1. Push **Pin Release Handle** down to pull out **Connecting Pins**.
2. Drive vehicle slowly to engage **Pushplates** into **Attachment Arms**.
3. Stand in front of blade. Fully raise **Pin Release Handle** to release **Connecting Pins**.
4. Push **Headgear** toward vehicle to allow **Connecting Pins** to fully engage **Pushplates**. If unable to push **Headgear** from in front of blade, stand in front of **Headgear** on driver side and push **Headlamp Bracket**.
5. Pull out **Jack Lock**. Push **Pin Release Handle** into **Stop**.
6. While holding **Jack Lock** out, use **Jack Handle** to raise **Jack** fully. Release **Jack Lock**.
7. Attach all electrical connectors.

**DETACH**

1. Place control in **Lower/Float** to pull blade down.
2. Pull and hold **Jack Lock** out. **Jack** will drop to ground. Then pull **Pin Release Handle** away from **Stop** and **Jack Lock**. Release **Jack Lock**. Verify that **Jack** is locked by trying to lift **Jack**.
3. Stand in front of blade. While pushing **Headgear** toward vehicle with left hand, push **Pin Release Handle** down to disengage **Connecting Pins**. Make sure **Connecting Pins** are fully retracted. If unable to push **Headgear** from in front of blade, stand in front of **Headgear** on driver side and push **Headlamp Bracket**.
4. Detach all electrical connectors.

Read Owner's Manual for complete instructions.

U.S. patents 6,098,608; 6,028,877; 6,711,837; 6,028,707; 6,944,378; 7,400,098; 7,430,021; 7,981,134; 7,737,076; 7,707,858; 8,200,418; 8,302,563; CN patents 2,324,207; 2,326,206; 2,682,102; 2,683,052; and other patents pending. 27483.12

## SAFETY PRECAUTIONS

Improper installation and operation could cause personal injury and/or equipment and property damage. Read and understand labels and the Owner's Manual before installing, operating or making adjustments.

### **⚠ WARNING**

**Lower blade when vehicle is parked. Temperature changes could change hydraulic pressure, causing the blade to drop unexpectedly or damaging hydraulic components. Failure to do this could result in serious personal injury.**

### **⚠ WARNING**

**The driver shall keep bystanders clear of the blade when it is being raised, lowered, or angled. Do not stand between vehicle and blade or within 8 feet of a moving blade. A moving or falling blade could cause personal injury.**

### **⚠ WARNING**

**Keep hands and feet clear of the blade and A-frame when mounting or removing the snowplow. Moving or falling assemblies could cause personal injury.**

### **⚠ WARNING**

**Do not exceed GVWR or GAWR including the blade and ballast. The rating label is found on the driver-side vehicle door cornerpost.**

### **⚠ WARNING**

**To prevent accidental movement of the blade, always turn the control OFF whenever the snowplow is not in use. The power indicator light will turn OFF.**

### **⚠ WARNING**

**Remove blade assembly before placing vehicle on hoist.**

### **⚠ CAUTION**

**Refer to the Kit Selection Guide for minimum vehicle recommendations and ballast requirements.**

## PERSONAL SAFETY

- Remove ignition key and put the vehicle in park or in gear to prevent others from starting the vehicle during installation or service.
- Wear only snug-fitting clothing while working on your vehicle or snowplow.
- Do not wear jewelry or a necktie, and secure long hair.
- Wear safety goggles to protect your eyes from battery acid, gasoline, dirt and dust.
- Avoid touching hot surfaces such as the engine, radiator, hoses and exhaust pipes.
- Always have a fire extinguisher rated BC handy, for flammable liquids and electrical fires.

## FIRE AND EXPLOSION

### **⚠ WARNING**

**Gasoline is highly flammable and gasoline vapor is explosive. Never smoke while working on vehicle. Keep all open flames away from gasoline tank and lines. Wipe up any spilled gasoline immediately.**

Be careful when using gasoline. Do not use gasoline to clean parts. Store only in approved containers away from sources of heat or flame.

## CELL PHONES

A driver's first responsibility is the safe operation of the vehicle. The most important thing you can do to prevent a crash is to avoid distractions and pay attention to the road. Wait until it is safe to operate Mobile Communication Equipment such as cell phones, text messaging devices, pagers, or two-way radios.

## VENTILATION

### **⚠ WARNING**

**Vehicle exhaust contains lethal fumes. Breathing these fumes, even in low concentrations, can cause death. Never operate a vehicle in an enclosed area without venting exhaust to the outside.**

**NOISE**

Airborne noise emission during use is below 70 dB(A) for the snowplow operator.









**VIBRATION**

Operating snowplow vibration does not exceed 2.5 m/s<sup>2</sup> to the hand-arm or 0.5 m/s<sup>2</sup> to the whole body.

**TORQUE CHART**

**⚠ CAUTION**

**Read instructions before assembling. Fasteners should be finger tight until instructed to tighten according to the torque chart. Use standard methods and practices when attaching snowplow including proper personal protective safety equipment.**

<b>Recommended Fastener Torque Chart</b>					
<b>Inch Fasteners Grade 5 and Grade 8</b>					
<b>Size</b>	<b>Torque (ft-lb)</b>		<b>Size</b>	<b>Torque (ft-lb)</b>	
	 <b>Grade 5</b>	 <b>Grade 8</b>		 <b>Grade 5</b>	 <b>Grade 8</b>
1/4-20	8.4	11.9	9/16-12	109	154
1/4-28	9.7	13.7	9/16-18	121	171
5/16-18	17.4	24.6	5/8-11	150	212
5/16-24	19.2	27.3	5/8-18	170	240
3/8-16	30.8	43.6	3/4-10	269	376
3/8-24	35.0	49.4	3/4-16	297	420
7/16-14	49.4	69.8	7/8-9	429	606
7/16-20	55.2	77.9	7/8-14	474	669
1/2-13	75.3	106.4	1-8	644	909
1/2-20	85.0	120.0	1-12	704	995
<b>Metric Fasteners Class 8.8 and 10.9</b>					
<b>Size</b>	<b>Torque (ft-lb)</b>		<b>Size</b>	<b>Torque (ft-lb)</b>	
	 <b>Class 8.8</b>	 <b>Class 10.9</b>		 <b>Class 8.8</b>	 <b>Class 10.9</b>
M6 x 1.00	7.7	11.1	M20 x 2.50	325	450
M8 x 1.25	19.5	26.9	M22 x 2.50	428	613
M10 x 1.50	38.5	53.3	M24 x 3.00	562	778
M12 x 1.75	67	93	M27 x 3.00	796	1139
M14 x 2.00	107	148	M30 x 3.50	1117	1545
M16 x 2.00	167	231	M33 x 3.50	1468	2101
M18 x 2.50	222	318	M36 x 4.00	1952	2701
These torque values apply to fasteners except those noted in the instructions.					

## INSTALLATION INSTRUCTIONS

**NOTE: For easier assembly and installation, vehicle and all snowplow components should be on a smooth, level, hard surface, such as concrete.**

### Mount

1. Remove the lower plastic portion of the bumper. Set aside the bumper section and fasteners.
2. Remove the tow hooks. Retain the fasteners and tow hooks for future reinstallation if the mount kit is removed from the vehicle.
3. Position the passenger-side mount against the truck frame so that the holes in the mount line up with the tow hook holes. Install the mount to the frame using  $5/8"$  x  $4-1/2"$  cap screws and  $5/8"$  locknuts. Hand tighten the fasteners.
4. Repeat on the driver's side.
5. Install the mount cross bar using four  $1/2"$  x  $1-1/2"$  cap screws and  $1/2"$  locknuts. Hand tighten the fasteners.
6. Measure between the mount connecting arms as shown. The distance should be  $28-7/8" \pm 1/8"$ . If necessary, use the supplied  $5/8"$  washers to shim one or both mounts in the appropriate direction to obtain the desired distance.

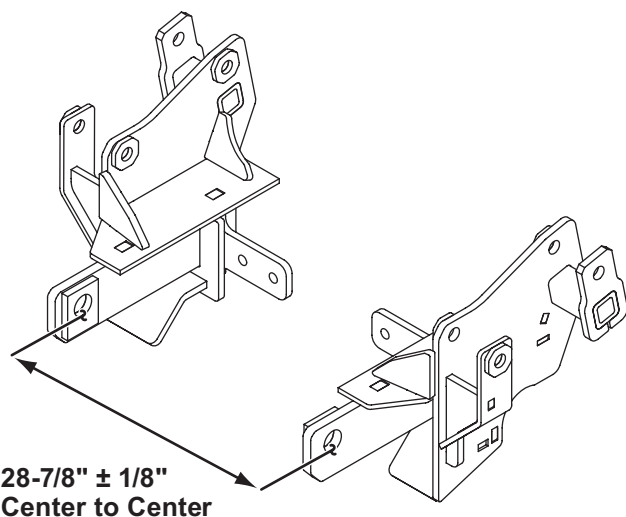

7. Tighten all fasteners according to the torque chart.
8. Reattach the lower plastic portion of the bumper using the original fasteners. Notch the bumper as needed to fit.

### Headlamp Extension Bracket

Install the supplied headlamp extension bracket according to the instructions packed with the 29596 Headlamp Extension Bracket Kit.

**NOTE: After five to ten hours of snowplow usage, retorque all mount assembly fasteners.**

Fisher Engineering reserves the right under its product improvement policy to change construction or design details and furnish equipment when so altered without reference to illustrations or specifications used. Fisher Engineering or the vehicle manufacturer may require or recommend optional equipment for snow removal. Do not exceed vehicle ratings with a snowplow. Fisher Engineering offers a limited warranty for all snowplows and accessories. See separately printed page for this important information. The following are registered (®) trademarks of Douglas Dynamics, LLC: FISHER®, Minute Mount® 2.

**Printed in U.S.A.**

---