

BLIZZARD[®] SNOWPLOW

VEHICLE UNDERCARRIAGE AND LIGHT ADAPTER SELECTION GUIDE

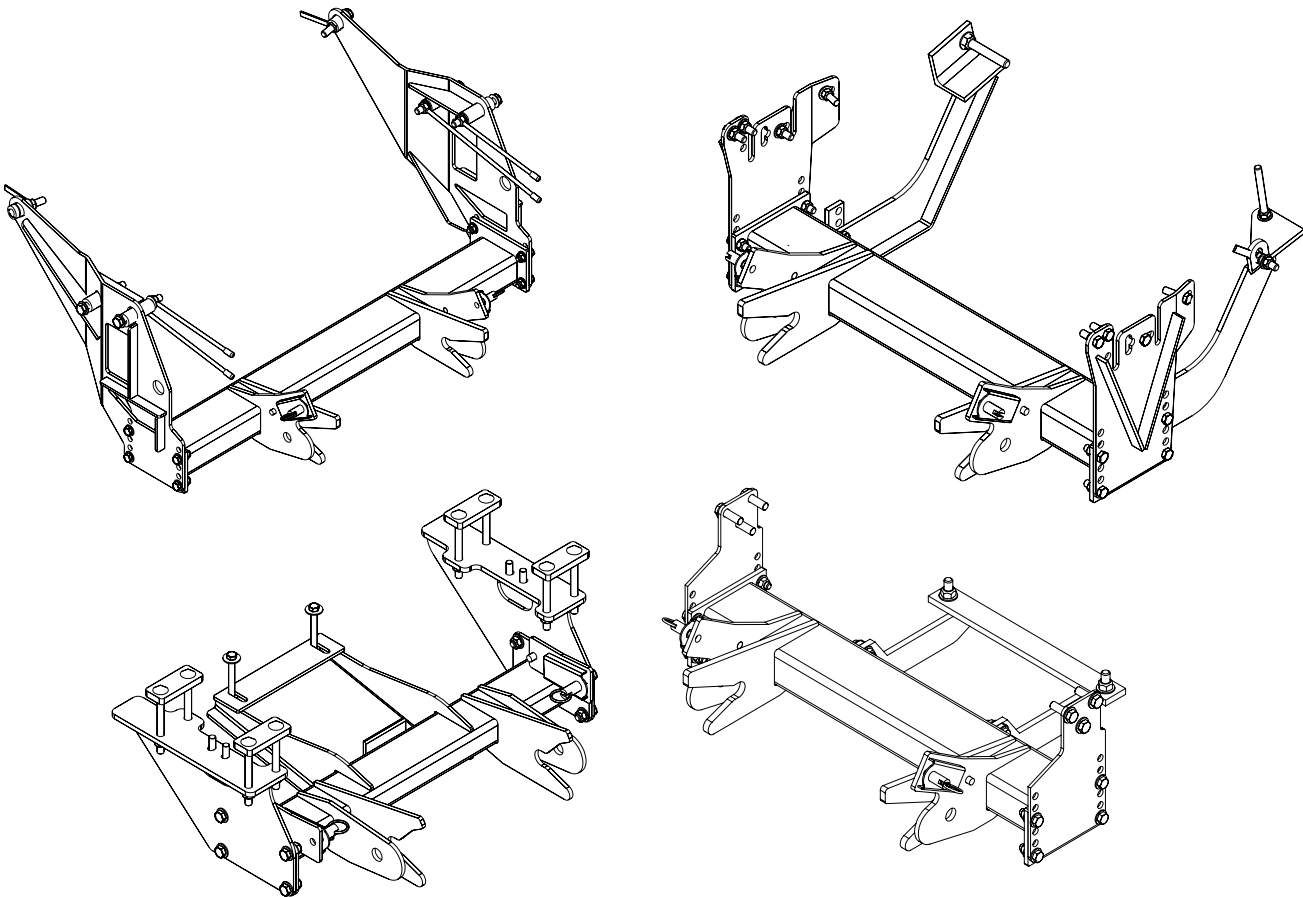

ABOUT THE SELECTION GUIDE

The Blizzard® Snowplows Vehicle Undercarriage & Light Adapter Selection Guide is a complete record of available undercarriage mounts and light adapters for use with Blizzard snowplows.

Additional undercarriage mounts and headlight adapters are continually being developed and will be added to this selection guide as they become available.

BLIZZARD CORPORATION RESERVES THE RIGHT, UNDER ITS CONTINUOUS IMPROVEMENT POLICY, TO CHANGE CONSTRUCTION OR DESIGN DETAILS AND FURNISH EQUIPMENT WHEN SO ALTERED WITHOUT REFERENCE TO ILLUSTRATIONS OR SPECIFICATIONS.

This guide provides recommended snowplow model applications for specific identified vehicle models. The use of this information by an authorized Blizzard dealer, or any person referencing or using this guide, for use in the process of a Blizzard snowplow installation, is solely the responsibility of that person or persons. Blizzard Corporation does not assume liability for damage to the purchaser's vehicle resulting from the attachment and use of a Blizzard snowplow. Vehicle risk is the sole responsibility of the purchaser. For additional information, review the Limited Consumer and Commercial Warranty documents at the back of this guide. These documents contain information regarding the term of warranty, warranty remedy, customer responsibility and warranty limitations for Blizzard Power Plow snowplows and Blizzard straight blade snowplows.

SAFETY

Review the Safety Precautions & Snowplow Undercarriage Installation Recommendations prior to performing an installation.

VEHICLE UNDERCARRIAGE MOUNTS

All truck-mounted Blizzard snowplows require a vehicle undercarriage mount to properly attach the snowplow to the vehicle. All available undercarriages (at the time of publication of this guide) can be referenced on the following pages.

In the event a Blizzard snowplow undercarriage mount does not fit, or requires modifications for proper installation (for a vehicle specified in the selection guide), complete the Vehicle Undercarriage Modification Notice form. Fax the document to Blizzard Engineering at 906-482-5445 or mail the document to: Blizzard Corporation Attn: Blizzard Engineering 95 Airpark Boulevard Calumet, MI 49913

LIGHT ADAPTERS

Review the Light Adapters to familiarize yourself with the construction of each Blizzard snowplow light adapter. The adapters are used to connect the vehicle headlights and original vehicle electrical harness to the main lighting harness on the snowplow vehicle electrical harness. *Note: Due to the differences in the construction of the headlight adapters, and the various make and model vehicles Blizzard snowplows can be installed on, light adapters are not included with the purchase of (or packaged with) a truck-mounted Blizzard snowplow.*

NOTE: The 64# on the lower left corner of the front cover is the part number for this manual. The letter in the box indicates the revision level.

TABLE OF CONTENTS

Safety..... 3
GM Selection Guide..... 4
GM Light Adapter Guide..... 5
Ford Selection Guide..... 6
Ford Light Adapter Guide..... 7
Dodge Selection Guide..... 8
Dodge Light Adapter Guide..... 9
Misc. Selection Guide..... 10
Misc. Light Adapter Guide..... 11
Installation instructions for
Light Adapters..... 12
Connector/Adapter Cross Ref... 13
62010..... 14
62011..... 16
62012..... 18
62013..... 20
62014..... 22
62015..... 24
62050..... 26
62051..... 28
62052..... 30
62053..... 32
62054..... 34
62170..... 36
62171..... 38
62197..... 40
62199..... 42
Vehicle Undercarriage
Modification Notice..... 43
Warranty..... 45

SAFETY PRECAUTIONS AND SNOWPLOW UNDERCARRIAGE INSTALLATION RECOMMENDATIONS

 **WARNING:** Always perform vehicle undercarriage installations with the keys removed from the vehicle's ignition. Properly tag the ignition switch to alert others work is being performed on the vehicle.

 **WARNING:** ALWAYS attach a "DO NOT OPERATE" tag to the ignition switch and/or steering wheel in the cab of the vehicle to alert others that service or maintenance is being performed. If necessary, place additional warning tags around the vehicle. Serious injury or death could occur if the engine is started and the vehicle and/or snowplow are moved while performing service or maintenance.

 **WARNING:** Most newer trucks are equipped with driver and passenger's side air bags. DO NOT remove, disable, or reposition any sensory equipment related to the safe operation of the air bags.

 **WARNING:** Vehicles equipped with air bags are designed to be activated in a frontal collision equivalent to hitting a solid object or barrier at approximately 14 mph or more. Careless or high speed driving while plowing snow, which results in vehicle impact deceleration equivalent to or greater than the airbag deployment threshold described above, would deploy the airbag. Review your vehicle Owner's Manual for specific information regarding airbag deployment.

 **WARNING:** ALWAYS follow the vehicle manufacturer's recommendations for installing snowplowing equipment.

 **CAUTION:** Always follow the maintenance guidelines in a timely manner. Failure to observe maintenance guidelines may result in poor snowplow operation, increased component wear or possibly lead to part failure.

- Note: Vehicles equipped with Blizzard Snowplows are recommended to be equipped with the vehicle manufacturer's recommended snowplow options (i.e. Snowplow prep packages).
- Note: The installation, modification or addition of accessories to Blizzard snowplow undercarriage mounts and/or snowplows must be in compliance with published Blizzard snowplow recommendations and instructions.
- Note: For some snowplow applications, it may be necessary to use a form of load boosting device to accommodate a snowplow installation. The use of suspension airbags, booster springs, Timbren kits or other similar load boosting devices is the responsibility of the snowplow purchaser. The selection, installation and purchase of load boosting devices is also the responsibility of the purchaser.
- Note: For some snowplow applications, it may be necessary to use a form of ballast to provide increased vehicle traction or maximum braking and handling. The use of ballast, such as sand bags, etc., is the responsibility of the snowplow purchaser. The selection, installation and purchase of ballast devices is also the responsibility of the purchaser.
- Note: For proper undercarriage installation, the vehicle must be parked on a level surface.
- Note: The recommended push beam height for Models 680LT and 720LT Blizzard straight blade snowplows is 10-1/2" from the center of the push beam to level ground. DO NOT exceed 12-1/2" in height for this push beam installation. Review the diagram to the right.
- Note: The recommended push beam height for Blizzard snowplow models 760LT, 760, 800, 860 810 and 8611 is 12-1/2" from the center of the push beam to level ground. DO NOT exceed 14-1/2" in height for these push beam installations. Review the diagram to the right.
- Note: Routinely inspect all undercarriage mount hardware for tightness. Review the recommended maximum bolt torque chart in your Blizzard snowplow Operation & Assembly manual.
- Note: Routinely clean and lubricate all electrical plugs, headlight connections, ground and battery cables, solenoid connections and switch connections to prevent corrosion. Apply dielectric grease for every 25 hours of snowplow use. You may need to grease more frequently depending on your plowing environment.
- Note: Follow all maintenance guidelines indicated in your Blizzard snowplow Operation & Assembly manual.
- Note: Follow all safety and warning labels indicated on the snowplow and/or in your Blizzard snowplow Operation & Assembly manual.

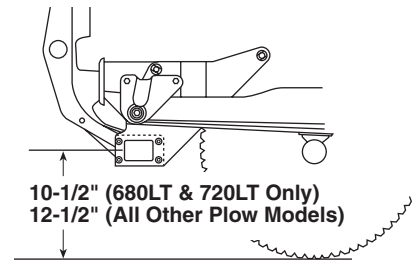

The recommended push beam height for the 680LT & 720LT undercarriage assembly is 10-1/2" from the center of the push beam to level ground.

The recommended push beam height for all other truck-mounted snowplow models is 12-1/2".

DO NOT exceed 12-1/2" (680LT & 720LT Only) or 14-1/2" (All other models) in height for these undercarriage assemblies.

 **CAUTION:** If your vehicle is equipped with oversize tires, they may come into contact with the undercarriage hanger plates when turning the vehicle.

The problem may be resolved by setting the steering stops on the vehicle. If this does not correct the problem, the original tires will need to be installed on the vehicle.

GM SELECTION GUIDE

VEHICLE MODEL APPLICATION	BLIZZARD MOUNT PN	SNOWPLOW MODEL APPLICATION							
		680LT	720LT	760LT	760	800	860	810	8611
04 COLORADO/CANYON	30186	X	X						
91-93 SONOMA									
83-94 S10 BLAZER/JIMMY									
83-93 S10 PICKUP	30185	X	X						
83-91 S15 JIMMY									
83-90 S15 PICKUP									
04 ENVOY	30174	X	X						
02-04 TRAILBLAZER									
95-03 BLAZER/JIMMY									
95-02 OLDS BRAVADA	30152	X	X						
94-03 S10 PICKUP/SONOMA									
95-03 BLAZER ZR2/JIMMY ZR2									
94-03 S10 ZR2/SONOMA ZR2	30141	X	X						
92-00 K1500 YUKON									
94-99 K1500 TAHOE									
92-99 K1500 SUBURBAN	30080			X					
92-94 K1500 BLAZER									
88-98 K1500 PICKUP									
02-03 K1500 AVALANCHE									
00-03 K1500 TAHOE/YUKON/YUKON XL	30087			X					
00-03 K1500 SUBURBAN									
99-04 K1500 SILVERADO/SIERRA									
99-03 K1500 SILVERADO/SIERRA W/ 3" LIFT	30088			X					
80-91 K1500 BLAZER/JIMMY									
80-91 K10/K1500 SUBURBAN	30089			X					
80-87 K10/K1500 PICKUP									
02-03 K2500 AVALANCHE					X	X	X		
01-03 K1500 HD SILVERADO/SIERRA					X	X	X	X	
01-03 K3500 PICKUP	30042				X	X	X	X	
00-03 K2500 SUBURBAN/YUKON XL					X	X	X		
99-05 K2500 SILVERADO/SIERRA					X	X	X	X	
92-99 K2500 SUBURBAN					X	X	X		
88-00 K2500 PICKUP	30043				X	X	X	X	
88-00 K3500 PICKUP					X	X	X	X	
82-91 K20/K2500 SUBURBAN					X	X	X		
82-87 K20/K2500 PICKUP	30055				X	X	X	X	
82-87 K30/K3500 PICKUP					X	X	X	X	
91-02 CHEV. C3500 HD CHASS. CAB (2WD)					X	X	X	X	
91-01 GMC C3500 HD CHASS. CAB	30071				X	X	X	X	
88-00 C3500 (2WD)					X	X	X	X	
03 C4500/5500 (2WD)	30172								X

www.storksplows.com
GM LIGHT ADAPTER GUIDE

VEHICLE MODEL APPLICATION	HEADLIGHT ADAPTER APPLICATION														
	62010	62011	62012	62013	62014	62015	62050	62051	62052	62053	62054	62170	62171	62197	62199
04 COLORADO/CANYON	X				X										
04 TRAILBLAZER/ENVOY														X	
02-03 TRAILBLAZER				X	X										
98-03 S10 PICKUP/BLAZER/JIMMY/SONOMA				X	X						X				
98-02 OLDS BRAVADA				X	X						X				
95-97 OLDS BRAVADA	X			X						X			X		
83-97 S10 PICKUP/BLAZER S15- JIMMY/PICKUP/SONOMA	X			X						X					
03 K1500 HD SILVERADO/SIERRA				X											
01-02 K1500 HD SILVERADO/SIERRA					X										
03-05 K1500 SILVERADO/SIERRA				X											
99-02 K1500 SILVERADO/SIERRA					X										
03 K1500 AVALANCHE/YUKON XL				X											
02 K1500 AVALANCHE					X										
03 K1500 TAHOE/YUKON				X											
00-02 K1500 TAHOE/YUKON/YUKON XL					X										
94-99 K1500 TAHOE	X			X		X									
92-00 K1500 YUKON	X			X		X									
03 K1500 SUBURBAN				X											
00-02 K1500 SUBURBAN					X										
92-99 K1500 SUBURBAN	X			X		X									
80-91 K10/K1500 SUBURBAN	X					X		X							
92-94 K1500 BLAZER	X			X		X									
88-98 K1500 PICKUP	X			X		X									
80-91 K1500 BLAZER/JIMMY	X					X		X							
80-87 K10/K1500 PICKUP	X					X		X							
03-04 K2500 SILVERADO/SIERRA				X											
99-02 K2500 SILVERADO/SIERRA					X										
03 K2500 AVALANCHE/YUKON XL				X											
02 K2500 AVALANCHE					X										
00-02 K2500 YUKON XL					X										
03 K2500 SUBURBAN				X											
00-02 K2500 SUBURBAN					X										
92-99 K2500 SUBURBAN	X			X		X									
73-91 K20/K2500 SUBURBAN	X					X		X							
88-00 K2500/K3500 PICKUP	X			X		X									
73-87 K20/K2500 K30/K3500 PICKUP	X					X		X							
03 K3500 PICKUP				X											
01-02 K3500 PICKUP					X										
91-02 CHEV.C3500 HD CHASS. CAB	X			X	X	X									
91-01 GMC C3500 HD CHASS. CAB	X			X	X	X									
88-00 C3500	X			X	X	X									
03 C4500/5500	X														
<i>Note: Some vehicle applications may have more than one headlight adapter identified. If so, please review adapter diagrams to help determine which adapter is needed.</i>															

GENERAL INSTALLATION INSTRUCTIONS FOR ALL HEADLIGHT ADAPTERS

- 1** Prior to installing the headlight adapters, verify the original vehicle equipment is in proper working order. Test the vehicle headlights (high and low beam), turn signals and run lights. Verify fog lamps or other optional lighting equipment is also in good working order if so equipped.
- 2** Remove the existing vehicle headlight connector from the headlight.
- 3** Plug the headlight adapter into the vehicle headlight receptacle. Note: If more than one plug is present, match the colors of each connector (gray to gray, black to black, Chevrolet daylight running: clear to gray, etc.).
- 4** Connect the existing vehicle headlight connector into the headlight adapter.
- 5** Plug the black (or gray depending on headlight adapter construction), 5-pin connector on the headlight adapter into the 5-pin connector on the vehicle wire harness.
- 6** Verify the vehicle and plow headlights are in proper working condition, including the turn lights. Adjust the plow headlight beams as needed.

CONNECTOR/ADAPTER CROSS REFERENCE

ADAPTER PN	CONNECTOR PN	DESCRIPTION	HEADLIGHT PN
62010	HB2, H4, 2B/2D	DUAL RECTANGULAR OR DUAL ROUND	9003, 6014/H6014, H6017, 6052, H6024, H6059, H6054/HP6054, H-54
62011	HB1	DUAL RECTANGULAR COMPOSITE HALOGEN	9004/H9004
62012	HB5	DUAL RECTANGULAR COMPOSITE HALOGEN	9007/H9007
62013	HB3/HB4	QUAD COMPOSITE HALOGEN	H9005, H9006
62014	HB3/HB4	QUAD COMPOSITE HALOGEN	H9005, H9006
62015	LF/UF	QUAD LOW PROFILE RECTANGULAR HALOGEN	H4701, H4703
62050	HB1/HB5	QUAD COMPOSITE HALOGEN	9004/H9004, 9007/H9007
62051	1A/2A	QUAD RECTANGULAR HEADLAMP	4651, H4651, 4652, H4652, H4656, H4662, HP6054
62052	H13	DUAL ROUND HALOGEN	H9008
62053	2E	DUAL RECTANGULAR (SMALL) HALOGEN	H4666, H6545, HP6545
62054	HB3/HB4	QUAD COMPOSITE HALOGEN	H9005, H9006
62170	HB3/HID	DUAL ROUND HIGH INTENSITY DISCHARGE LAMP	H9005, D1R-HID MODULE
62171	HB3/HB6	QUAD COMPOSITE HALOGEN	H9005, H9006
62197	HB3/HB7	QUAD COMPOSITE HALOGEN	H9005, H9006
62199			

Note: 62013 The switch between low and high beams is one the positive (power) side of the headlight bulb.

Note: 62014 The switch between low and high beams is one the negative (ground) side of the headlight bulb.

Note: 62053 Headlight adapter construction may contain loose spade terminals or a molded connector. Use a test light to determine the correct connections for each terminal.

Note: 62054 "A" Commons; The switch between high and low beams is on the negative (ground) side of the headlight bulb. Daytime running lights are run through the high beam bulbs.

Note: 62171 "B" Commons; The switch between high and low beams is on the negative (ground) side of the headlight bulb. Daytime running lights are run through the high beam bulbs.

LIGHT ADAPTER NUMBER	VEHICLE MODEL APPLICATION
	04 COLORADO/CANYON*
	95-97 OLDS BRAVADA*
	83-97 S10 PICKUP/BLAZER S15-JIMMY/PICKUP/SONOMA*
	94-99 K1500 TAHOE*
	92-00 K1500 YUKON*
	92-99 K1500 SUBURBAN*
	80-91 K10/K1500 SUBURBAN*
	92-94 K1500 BLAZER*
	88-98 K1500 PICKUP*
	80-91 K1500 BLAZER/JIMMY*
	80-87 K10/K1500 PICKUP*
	92-99 K2500 SUBURBAN*
	73-91 K20/K2500 SUBURBAN*
	88-00 K2500/K3500 PICKUP*
	73-87 K20/K2500 K30/K3500 PICKUP*
	91-02 CHEV. C3500 HD CHASS. CAB*
	91-01 GMC C3500 HD CHASS. CAB*
	88-00 C3500*
	03 C4500/5500
	83-03 RANGER PICKUP*
	91-01 EXPLORER*
62010	83-90 BRONCO II*
	80-91 F-150 PICKUP*
	80-91 BRONCO*
	00-03 EXCURSION*
	92-04 F-250 SUPER DUTY*
	80-91 F-250 PICKUP*
	99-04 F-350 PICKUP*
	80-91 F-350 PICKUP*
	04 F-650 SD COMMERCIAL*
	99-03 F-650 SD COMMERCIAL*
	72-93 W200/W250 PICKUP
	72-93 W300/W350 PICKUP
	97-03 WRANGLER TJ
	87-96 WRANGLER YJ
	84-01 CHEROKEE XJ
	84-93 WAGONEER LTD
	86-92 COMANCHE MJ
	99-03 FL 40/50/60/70*
	03 MITSUBISHI FUSO FG*
	98-00 NISSAN FRONTIER*
	86.5-97 NISSAN PICKUP*
	95-03 TOYOTA TACOMA
	00-03 TOYOTA TUNDRA
	NOTE: If vehicle model application is marked with an asterisk (*) then more than one light adapter may be specified. See light adapter diagrams and connector/adaptor cross reference pages to determine which adapter is required.

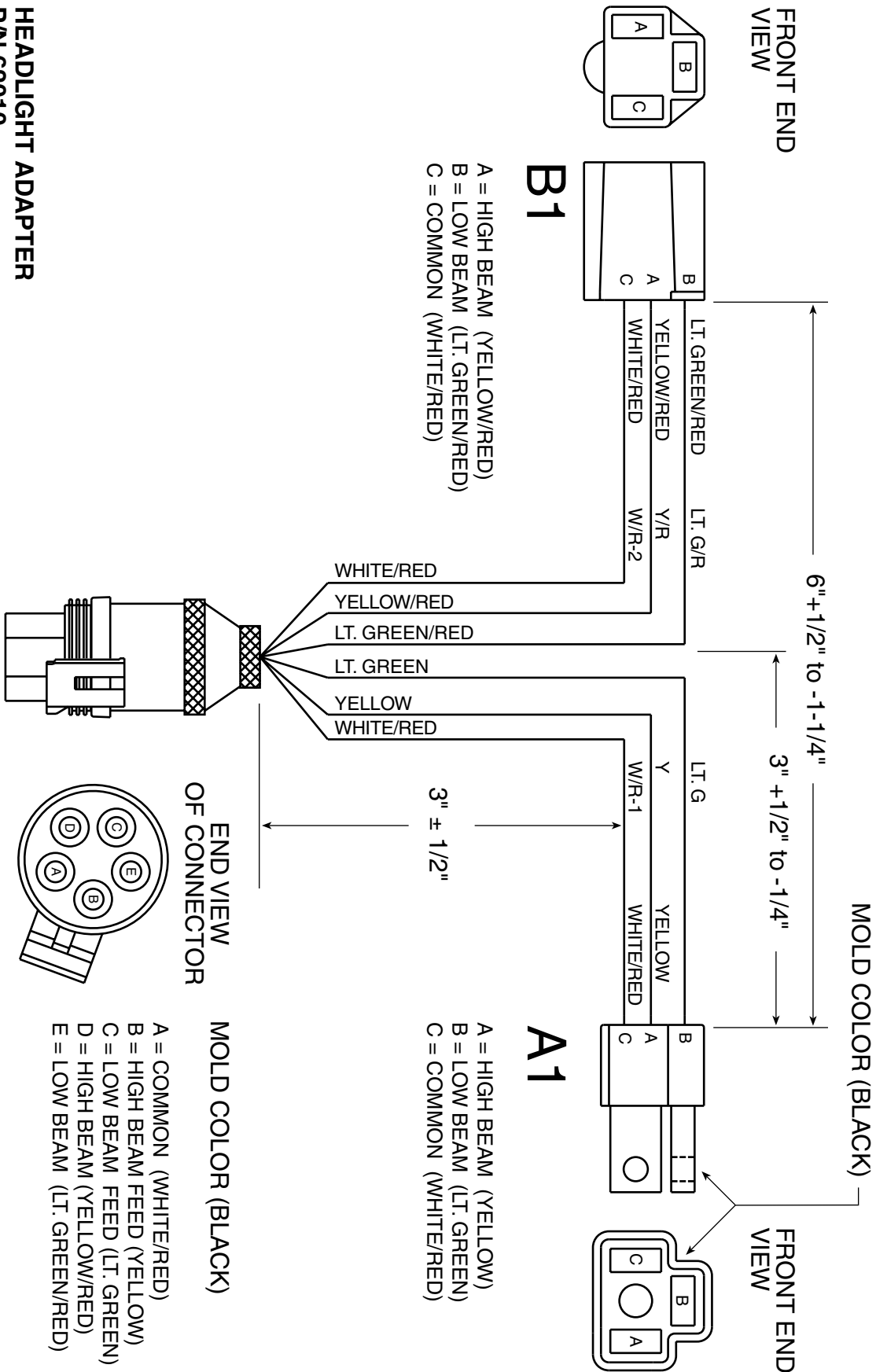

HEADLIGHT ADAPTER

P/N 62010

HEADLIGHT CONNECTOR(S): HB2, H4, 2B/2D
 HEADLIGHT DESCRIPTION: DUAL RECTANGULAR OR DUAL ROUND
 HEADLIGHT BULB NUMBER(S): 9003, 6014, H6014, H6017, 6052, H6024, H6059, H6054, HP6054, H-54

• NOT DRAWN TO SCALE
 • UNLESS OTHERWISE SPECIFIED ALL DIMENSIONS IN INCHES
 VENDOR P/N & DWG: 95-2331-00 REV A (REF. M.P.M. 90-2015-00)

LIGHT ADAPTER NUMBER	VEHICLE MODEL APPLICATION
62011	83-03 RANGER PICKUP*
	91-01 EXPLORER*
	83-90 BRONCO II*
	80-91 F-150 PICKUP*
	80-91 BRONCO*
	80-91 F-250 PICKUP*
	80-91 F-350 PICKUP*
	87-96 DAKOTA PICKUP*
	94-01 1500 RAM PICKUP
	03-04 2500 RAM PICKUP*
	94-02 2500 RAM PICKUP
	03 3500 RAM PICKUP
	94-02 3500 RAM PICKUP
	98-00 NISSAN FRONTIER*
86.5-97 NISSAN PICKUP*	
	NOTE: If vehicle model application is marked with an asterisk (*) then more than one light adapter may be specified. See light adapter diagrams and connector/adaptor cross reference pages to determine which adapter is required.

FRONT END VIEW

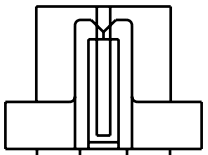
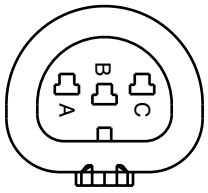

C YELLOW/RED
B LT. GREEN/RED
A WHITE/RED

B1

A = COMMON (WHITE/RED)
B = LOW BEAM (LT. GREEN/RED)
C = HIGH BEAM (YELLOW/RED)

6" ± 1/2"

WHITE/RED
YELLOW/RED
LT. GREEN/RED
LT. GREEN
YELLOW
WHITE/RED

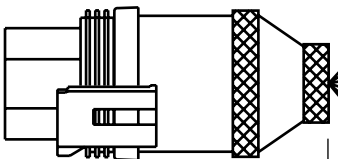

Y
LT. G
W/R-1
WHITE/RED

3" ± 1/2"

MOLD COLOR (GRAY)

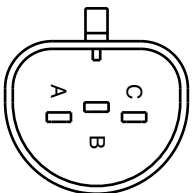
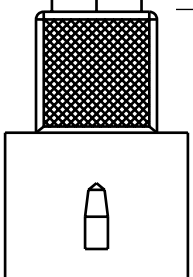

A1

A = COMMON (WHITE/RED)
B = LOW BEAM (LT. GREEN)
C = HIGH BEAM (YELLOW)

FRONT END VIEW

END VIEW OF CONNECTOR

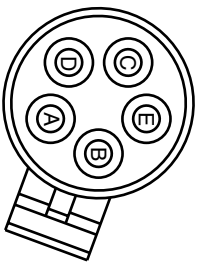

MOLD COLOR (BLACK)

A = COMMON (WHITE/RED)
B = HIGH BEAM FEED (YELLOW)
C = LOW BEAM FEED (LT. GREEN)
D = HIGH BEAM (YELLOW/RED)
E = LOW BEAM (LT. GREEN/RED)

HEADLIGHT ADAPTER

P/N 62011

HEADLIGHT CONNECTOR(S): HB1
HEADLIGHT DESCRIPTION: DUAL RECTANGULAR COMPOSITE HALOGEN
HEADLIGHT BULB NUMBER(S): 9004, H9004

• NOT DRAWN TO SCALE
• UNLESS OTHERWISE SPECIFIED ALL DIMENSIONS IN INCHES
VENDOR P/N & DWG: 95-2332-00 REV A (REF. M.P.M. 90-2016-00)

LIGHT ADAPTER NUMBER	VEHICLE MODEL APPLICATION
62012	01-04 EXPLORER SPORT TRAC
	04 RANGER PICKUP
	83-03 RANGER PICKUP*
	91-01 EXPLORER*
	98-01 MERCURY MOUNTAINEER
	83-90 BRONCO II*
	94-02 B3000/B4000
	02-03 F-150 FX4 PICKUP
	92-03 F-150 PICKUP
	99-03 EXPEDITION
	92-96 BRONCO
	00-03 EXCURSION*
	92-04 F-250 SUPER DUTY*
	92-99 F-250 HD PICKUP
	99-04 F-350 PICKUP
	92-98 F-350 PICKUP
	99-04 F-450/F-550 SUPER DUTY PICKUP
	04 DURANGO
	98-03 DURANGO/DURANGO SLT
	97-03 DAKOTA SLT EXT CAB/PICKUP
02-04 1500 RAM PICKUP	
03-04 2500 RAM PICKUP*	
04 LIBERTY	
01-03 NISSAN FRONTIER	
	NOTE: If vehicle model application is marked with an asterisk (*) then more than one light adapter may be specified. See light adapter diagrams and connector/adaptor cross reference pages to determine which adapter is required.

FRONT END VIEW

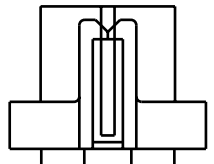
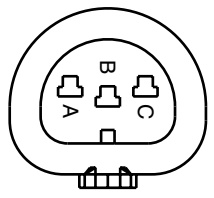

A = LOW BEAM (LT. GREEN/RED)
 B = COMMON (WHITE/RED)
 C = HIGH BEAM (YELLOW/RED)

B1

6" ± 1/2"

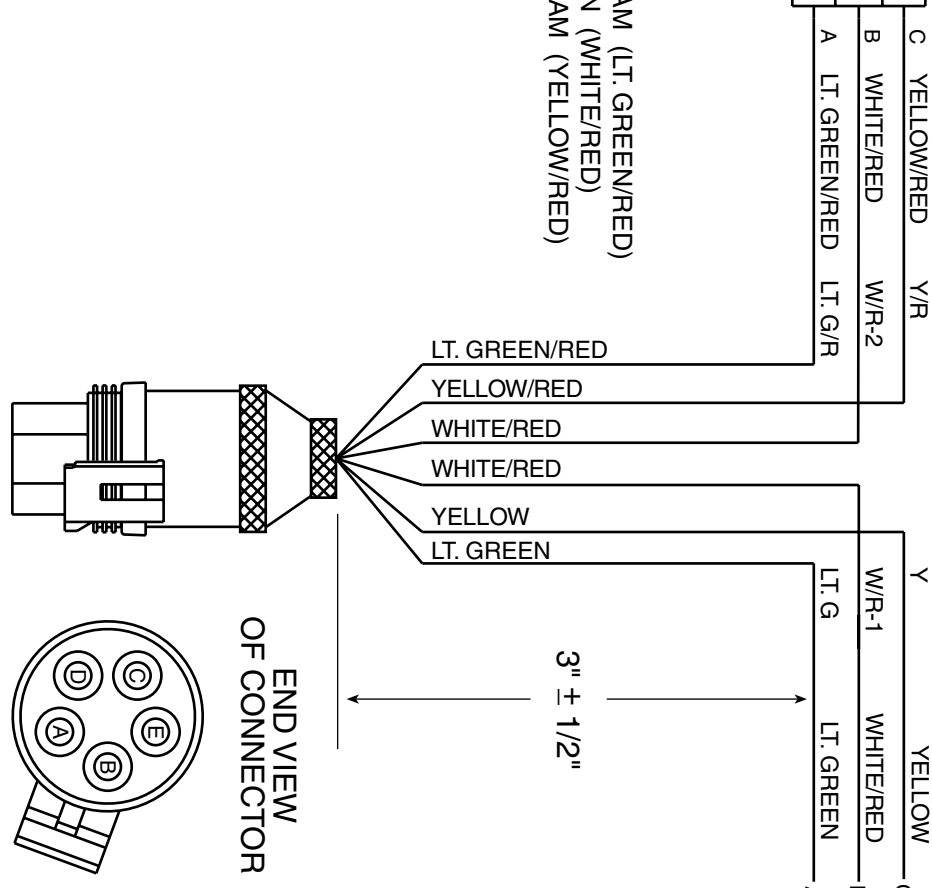

3" ± 1/2"

MOLD COLOR (BLACK)

FRONT END VIEW

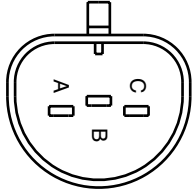
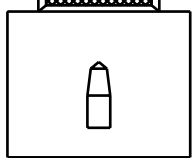

A = LOW BEAM (LT. GREEN)
 B = COMMON (WHITE/RED)
 C = HIGH BEAM (YELLOW)

A1

END VIEW OF CONNECTOR

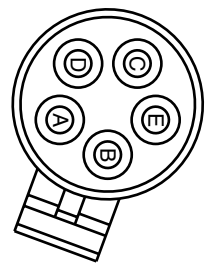

MOLD COLOR (BLACK)

A = COMMON (WHITE/RED)
 B = HIGH BEAM FEED (YELLOW)
 C = LOW BEAM FEED (LT. GREEN)
 D = HIGH BEAM (YELLOW/RED)
 E = LOW BEAM (LT. GREEN/RED)

HEADLIGHT ADAPTER

P/N 62012

HEADLIGHT CONNECTOR(S): HBS
 HEADLIGHT DESCRIPTION: DUAL RECTANGULAR COMPOSITE HALOGEN
 HEADLIGHT BULB NUMBER(S): 9007, H9007

• NOT DRAWN TO SCALE
 • UNLESS OTHERWISE SPECIFIED ALL DIMENSIONS IN INCHES
 VENDOR P/N & DWG: 95-2333-00 REV A (REF. M.P.M 90-2017-00)

LIGHT ADAPTER NUMBER	VEHICLE MODEL APPLICATION
62013	02-03 TRAILBLAZER*
	98-03 S10 PICKUP/BLAZER/JIMMY/SONOMA*
	98-02 OLDS BRAVADA*
	95-97 OLDS BRAVADA*
	83-97 S10 PICKUP/BLAZER S15-JIMMY/PICKUP/SONOMA*
	03 K1500 HD SILVERADO/SIERRA
	03-04 K1500 SILVERADO/SIERRA
	03 K1500 AVALANCHE/YUKON XL
	03 K1500 TAHOE/YUKON
	94-99 K1500 TAHOE*
	92-00 K1500 YUKON*
	03 K1500 SUBURBAN
	92-99 K1500 SUBURBAN*
	92-94 K1500 BLAZER*
	88-98 K1500 PICKUP*
	03-04 K2500 SILVERADO/SIERRA
	03 K2500 AVALANCHE/YUKON XL
	03 K2500 SUBURBAN
	92-99 K2500 SUBURBAN*
	88-00 K2500/K3500 PICKUP*
	03 K3500 PICKUP
	91-02 CHEV.C3500 HD CHASS. CAB*
	91-01 GMC C3500 HD CHASS. CAB*
	88-00 C3500*
	02-04 EXPLORER
	02 MERCURY MOUNTAINEER
04 EXPEDITION	
Note: 62013 The switch between low and high beams is one the positive (power) side of the headlight bulb.	
	NOTE: If vehicle model application is marked with an asterisk (*) then more than one light adapter may be specified. See light adapter diagrams and connector/adapter cross reference pages to determine which adapter is required.

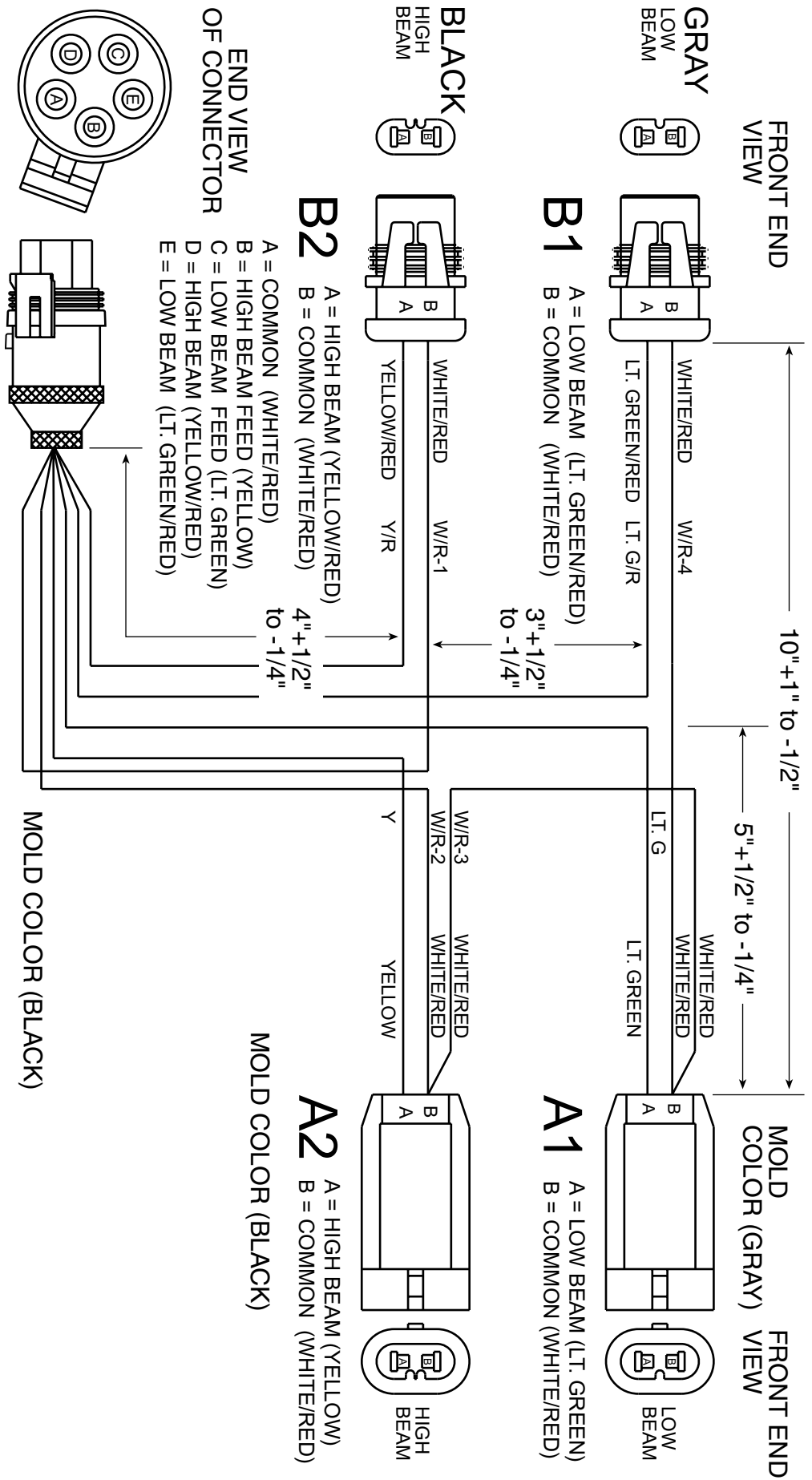

HEADLIGHT ADAPTER

P/N 62013

HEADLIGHT CONNECTOR(S): HB3/HB4
 HEADLIGHT DESCRIPTION: QUAD COMPOSITE HALOGEN
 HEADLIGHT BULB NUMBER(S): H9005, H9006

• NOT DRAWN TO SCALE
 • UNLESS OTHERWISE SPECIFIED ALL DIMENSIONS IN INCHES
 VENDOR P/N & DWG: 95-2394-00 REV A (REF. M.P.M. 90-2018-00)

NOTE: THE SWITCH BETWEEN LOW AND HIGH BEAMS IS ON THE POSITIVE (POWER) SIDE OF THE HEADLIGHT BULB.

LIGHT ADAPTER NUMBER	VEHICLE MODEL APPLICATION
62014	04 COLORADO/CANYON*
	02-03 TRAILBLAZER*
	98-03 S10 PICKUP/BLAZER/JIMMY/SONOMA*
	98-02 OLDS BRAVADA*
	01-02 K1500 HD SILVERADO/SIERRA
	99-02 K1500 SILVERADO/SIERRA
	02 K1500 AVALANCHE
	00-02 K1500 TAHOE/YUKON/YUKON XL
	00-02 K1500 SUBURBAN
	99-02 K2500 SILVERADO/SIERRA
	02 K2500 AVALANCHE
	00-02 K2500 YUKON XL
	00-02 K2500 SUBURBAN
	01-02 K3500 PICKUP
	91-02 CHEV.C3500 HD CHASS. CAB*
91-01 GMC C3500 HD CHASS. CAB*	
88-00 C3500*	
	04 NISSAN TITAN*
Note: 62014 The switch between low and high beams is one the negative (ground) side of the headlight bulb.	
	NOTE: If vehicle model application is marked with an asterisk (*) then more than one light adapter may be specified. See light adapter diagrams and connector/adapter cross reference pages to determine which adapter is required.

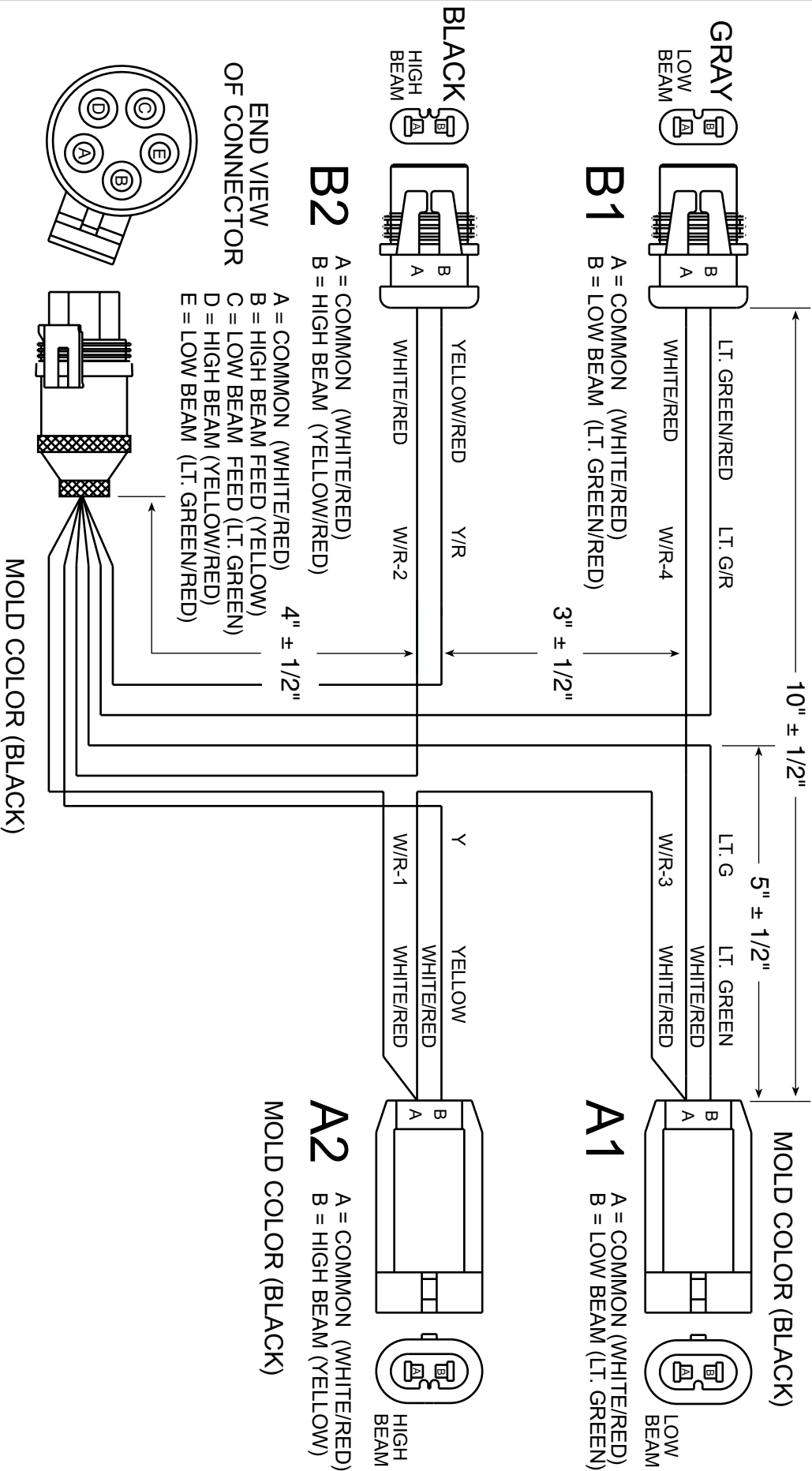

HEADLIGHT ADAPTER

P/N 62014

HEADLIGHT CONNECTOR(S): HB3/HB4

HEADLIGHT DESCRIPTION: QUAD COMPOSITE HALOGEN

HEADLIGHT BULB NUMBER(S): H9005, H9006

• NOT DRAWN TO SCALE

• UNLESS OTHERWISE SPECIFIED ALL DIMENSIONS IN INCHES

VENDOR P/N & DWG: 95-2341-00 REV A (REF: M.P. A. 90-2025-00)

NOTE: THE SWITCH BETWEEN LOW AND HIGH BEAMS IS ON THE NEGATIVE (GROUND) SIDE OF THE HEADLIGHT BULB.

LIGHT ADAPTER NUMBER	VEHICLE MODEL APPLICATION
62015	94-99 K1500 TAHOE*
	92-00 K1500 YUKON*
	92-99 K1500 SUBURBAN*
	80-91 K10/K1500 SUBURBAN*
	92-94 K1500 BLAZER*
	88-98 K1500 PICKUP*
	80-91 K1500 BLAZER/JIMMY*
	80-87 K10/K1500 PICKUP*
	92-99 K2500 SUBURBAN*
	73-91 K20/K2500 SUBURBAN*
	88-00 K2500/K3500 PICKUP*
	73-87 K20/K2500 K30/K3500 PICKUP*
	91-02 CHEV.C3500 HD CHASS. CAB*
	91-01 GMC C3500 HD CHASS. CAB*
	88-00 C3500*
85-98 WAGONEER	
	NOTE: If vehicle model application is marked with an asterisk (*) then more than one light adapter may be specified. See light adapter diagrams and connector/adaptor cross reference pages to determine which adapter is required.

FRONT END VIEW

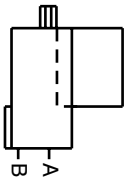
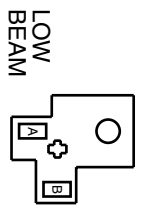

10" + 1" to -1/2"

5" + 1/2" to -1/4"

FRONT END VIEW

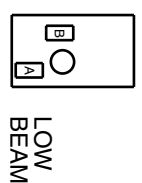

B1
A = COMMON (WHITE/RED)
B = LOW BEAM (LT. GREEN/RED)

A1
A = COMMON (WHITE/RED)
B = LOW BEAM (LT. GREEN)

FRONT END VIEW

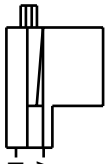
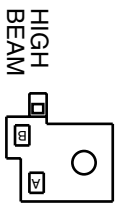

3" + 1/2" to -1/4"

PVC CONNECTOR MOLD COLOR (BLACK)

FRONT END VIEW

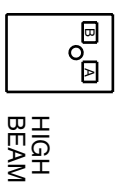

B2
A = COMMON (WHITE/RED)
B = HIGH BEAM (YELLOW/RED)

A2
A = COMMON (WHITE/RED)
B = HIGH BEAM (YELLOW)

END VIEW OF CONNECTOR

A = COMMON (WHITE/RED)
B = HIGH BEAM FEED (YELLOW)
C = LOW BEAM FEED (LT. GREEN)
D = HIGH BEAM (YELLOW/RED)
E = LOW BEAM (LT. GREEN/RED)

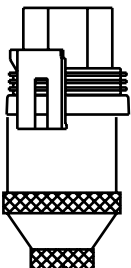
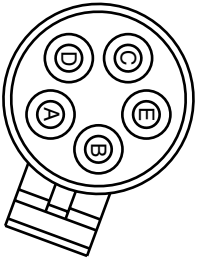

MOLD COLOR (BLACK)

HEADLIGHT ADAPTER

P/N 62015

HEADLIGHT CONNECTOR(S): LF/UF
HEADLIGHT DESCRIPTION: QUAD LOW PROFILE RECTANGULAR HALOGEN
HEADLIGHT BULB NUMBER(S): H4701, H4703

* NOT DRAWN TO SCALE
* UNLESS OTHERWISE SPECIFIED ALL DIMENSIONS IN INCHES
VENDOR P/N & DWG: 95-2335-00 REV A (REF M.P.M. 90-2019-00)

LIGHT ADAPTER NUMBER	VEHICLE MODEL APPLICATION
62050	97-03 DAKOTA SPORT PICKUP
	99-01 1500 RAM SPORT
	99-02 2500 RAM SPORT
	99-02 3500 RAM SPORT
	NOTE: If vehicle model application is marked with an asterisk (*) then more than one light adapter may be specified. See light adapter diagrams and connector/adapter cross reference pages to determine which adapter is required.

FRONT END VIEW

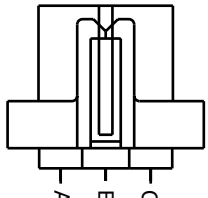
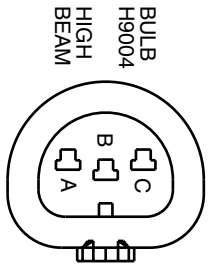

YELLOW/RED Y/R-2
CAVITY PLUG NOT USED
WHITE/RED W/R-2
9" ± 1/4"

B2

A = COMMON (WHITE/RED)
B = NOT USED (CAVITY PLUG)
C = HIGH BEAM (YELLOW/RED)

MOLD COLOR (BLACK)
FRONT END VIEW

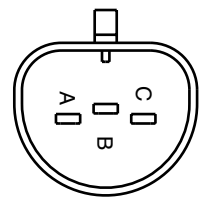
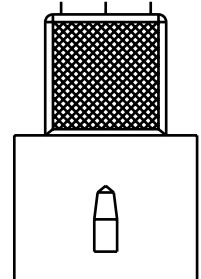

A1

A = LOW BEAM (LT. GREEN)
B = COMMON (WHITE/RED)
C = HIGH BEAM (YELLOW)

FRONT END VIEW

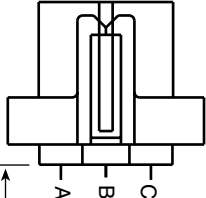
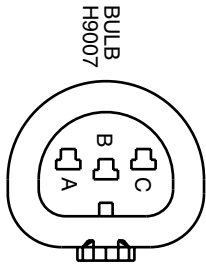

YELLOW/RED Y/R-1
WHITE/RED W/R-3
LT. GREEN/RED LT.G/R
6" - 1/2" ± 1/2"

B1

A = LOW BEAM (LT. GREEN/RED)
B = COMMON (WHITE/RED)
C = HIGH BEAM (YELLOW/RED)

3" - 1/4" ± 1/4"
YELLOW Y
WHITE/RED W/R-1
WHITE/RED W/R-2
LT. GREEN LT.G

3" - 1/4" ± 1/4"

END VIEW OF CONNECTOR

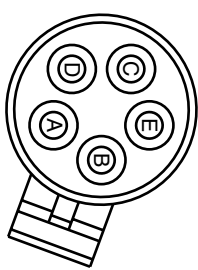

MOLD COLOR (BLACK)

A = COMMON (WHITE/RED)
B = HIGH BEAM FEED (YELLOW)
C = LOW BEAM FEED (LT. GREEN)
D = HIGH BEAM (YELLOW/RED)
E = LOW BEAM (LT. GREEN/RED)

HEADLIGHT ADAPTER

P/N 62050

HEADLIGHT CONNECTOR(S): HB1/HB5
HEADLIGHT DESCRIPTION: QUAD COMPOSITE HALOGEN
HEADLIGHT BULB NUMBER(S): 9004, H9004, 9007, H9007

• NOT DRAWN TO SCALE
• UNLESS OTHERWISE SPECIFIED ALL DIMENSIONS IN INCHES
VENDOR P/N & DWG: 95-2338-00 REV A (REF. M.P.M. 90-2022-00)

LIGHT ADAPTER NUMBER	VEHICLE MODEL APPLICATION
62051	80-91 K10/K1500 SUBURBAN*
	80-91 K1500 BLAZER/JIMMY*
	80-87 K10/K1500 PICKUP*
	73-91 K20/K2500 SUBURBAN*
	73-87 K20/K2500 K30/K3500 PICKUP*
	04 F-650 SD COMMERCIAL*
	99-03 F-650 SD COMMERCIAL*
	99-03 FL 40/50/60/70*
	03 MITSUBISHI FUSO FG*
	NOTE: If vehicle model application is marked with an asterisk (*) then more than one light adapter may be specified. See light adapter diagrams and connector/adaptor cross reference pages to determine which adapter is required.

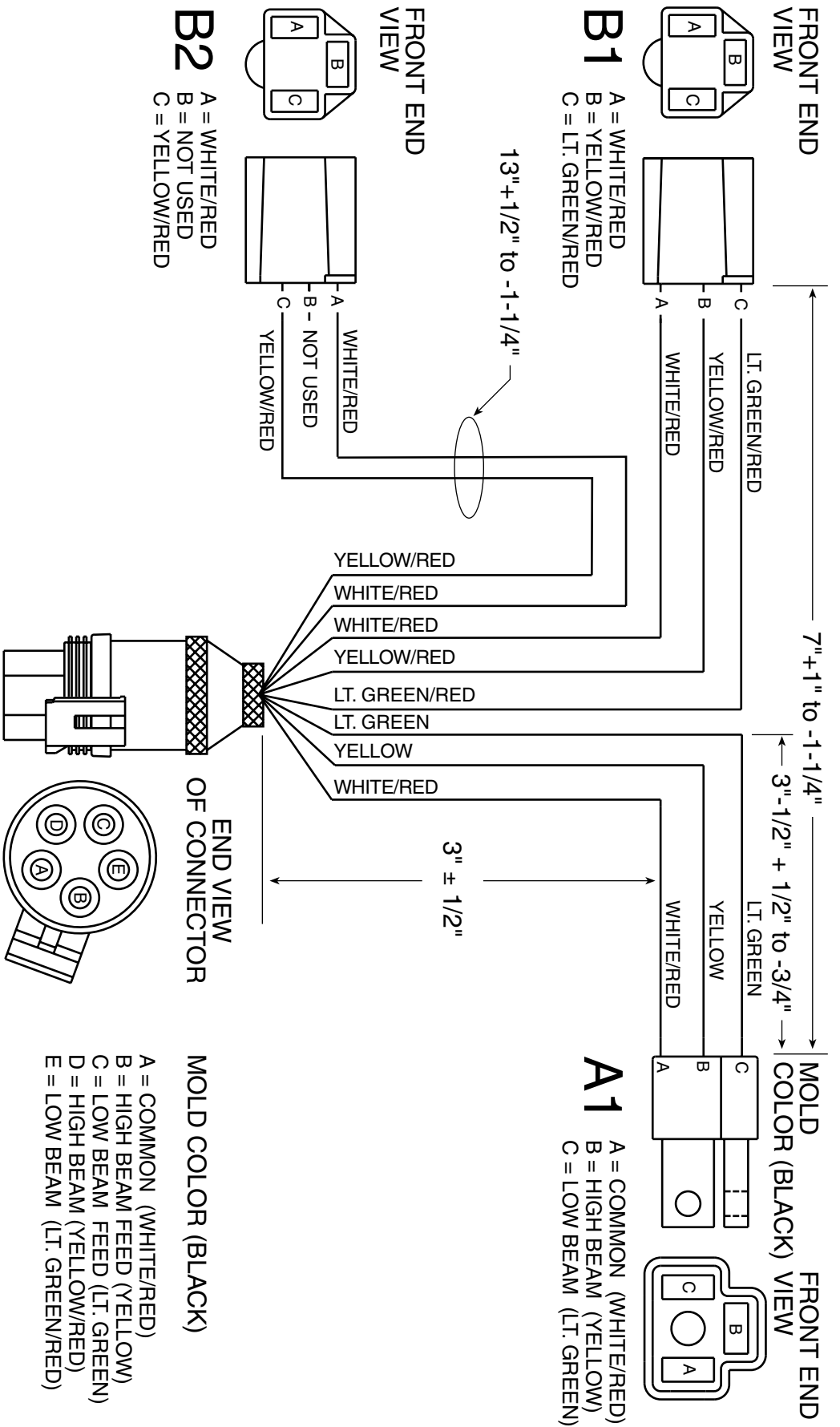

HEADLIGHT ADAPTER
P/N 62051
 HEADLIGHT CONNECTOR(S): 1A/2A
 HEADLIGHT DESCRIPTION: QUAD RECTANGULAR
 HEADLIGHT BULB NUMBER(S): 4651, H4651, 4652, H4652, H4656, H4662, HP6054

* NOT DRAWN TO SCALE
 * UNLESS OTHERWISE SPECIFIED ALL DIMENSIONS IN INCHES
 VENDOR P/N & DWG: 95-2337-00 REV A (REF. M.P.M. 90-2021-00)

LIGHT ADAPTER NUMBER	VEHICLE MODEL APPLICATION
62052	04 F-150 PICKUP
	NOTE: If vehicle model application is marked with an asterisk (*) then more than one light adapter may be specified. See light adapter diagrams and connector/adapter cross reference pages to determine which adapter is required.

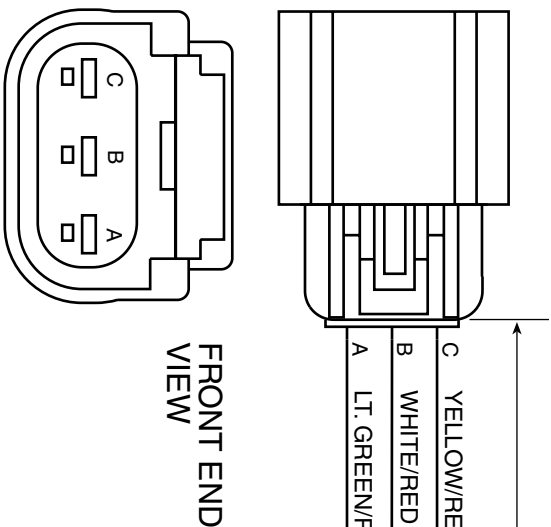

B1
 A = LOW BEAM (LT. GREEN/RED)
 B = COMMON (WHITE/RED)
 C = HIGH BEAM (YELLOW/RED)

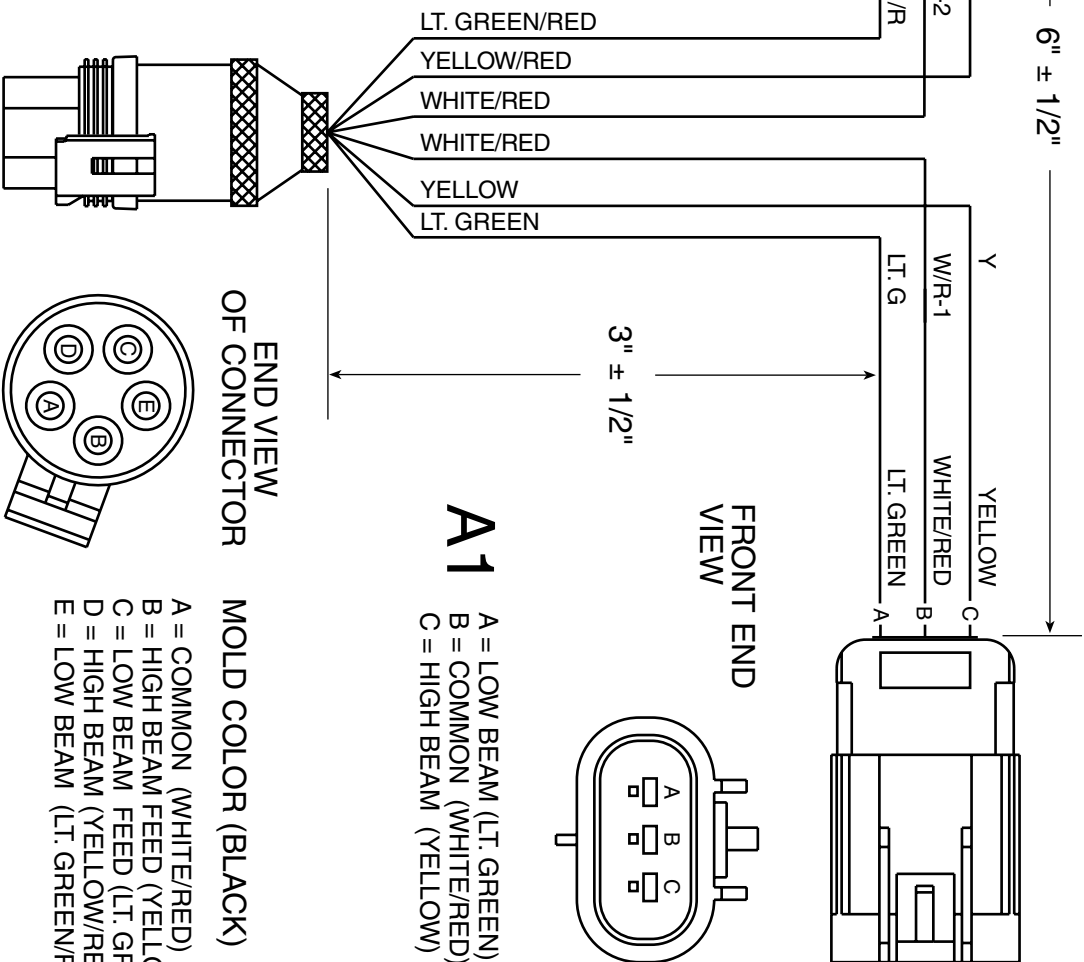

A1
 A = LOW BEAM (LT. GREEN)
 B = COMMON (WHITE/RED)
 C = HIGH BEAM (YELLOW)

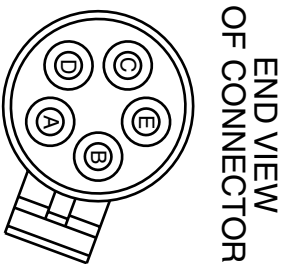

MOLD COLOR (BLACK)
 A = COMMON (WHITE/RED)
 B = HIGH BEAM FEED (YELLOW)
 C = LOW BEAM FEED (LT. GREEN)
 D = HIGH BEAM (YELLOW/RED)
 E = LOW BEAM (LT. GREEN/RED)

HEADLIGHT ADAPTER
P/N 62052
 HEADLIGHT CONNECTOR(S): H13
 HEADLIGHT DESCRIPTION: DUAL ROUND HALOGEN
 HEADLIGHT BULB NUMBER(S): H9008

• NOT DRAWN TO SCALE
 • UNLESS OTHERWISE SPECIFIED ALL DIMENSIONS IN INCHES
 VENDOR P/N & DWG: 95-2343-00 REV A (REF. M.P.M. 90-2027-00)

LIGHT ADAPTER NUMBER	VEHICLE MODEL APPLICATION
62053	95-97 OLDS BRAVADA*
	83-97 S10 PICKUP/BLAZER S15-JIMMY/PICKUP/SONOMA*
	87-96 DAKOTA PICKUP*
<p>Note: 62053 Headlight adapter construction may contain loose spade terminals or a molded connector. Use a test light to determine the correct connections for each terminal.</p>	
	<p>NOTE: If vehicle model application is marked with an asterisk (*) then more than one light adapter may be specified. See light adapter diagrams and connector/adapter cross reference pages to determine which adapter is required.</p>

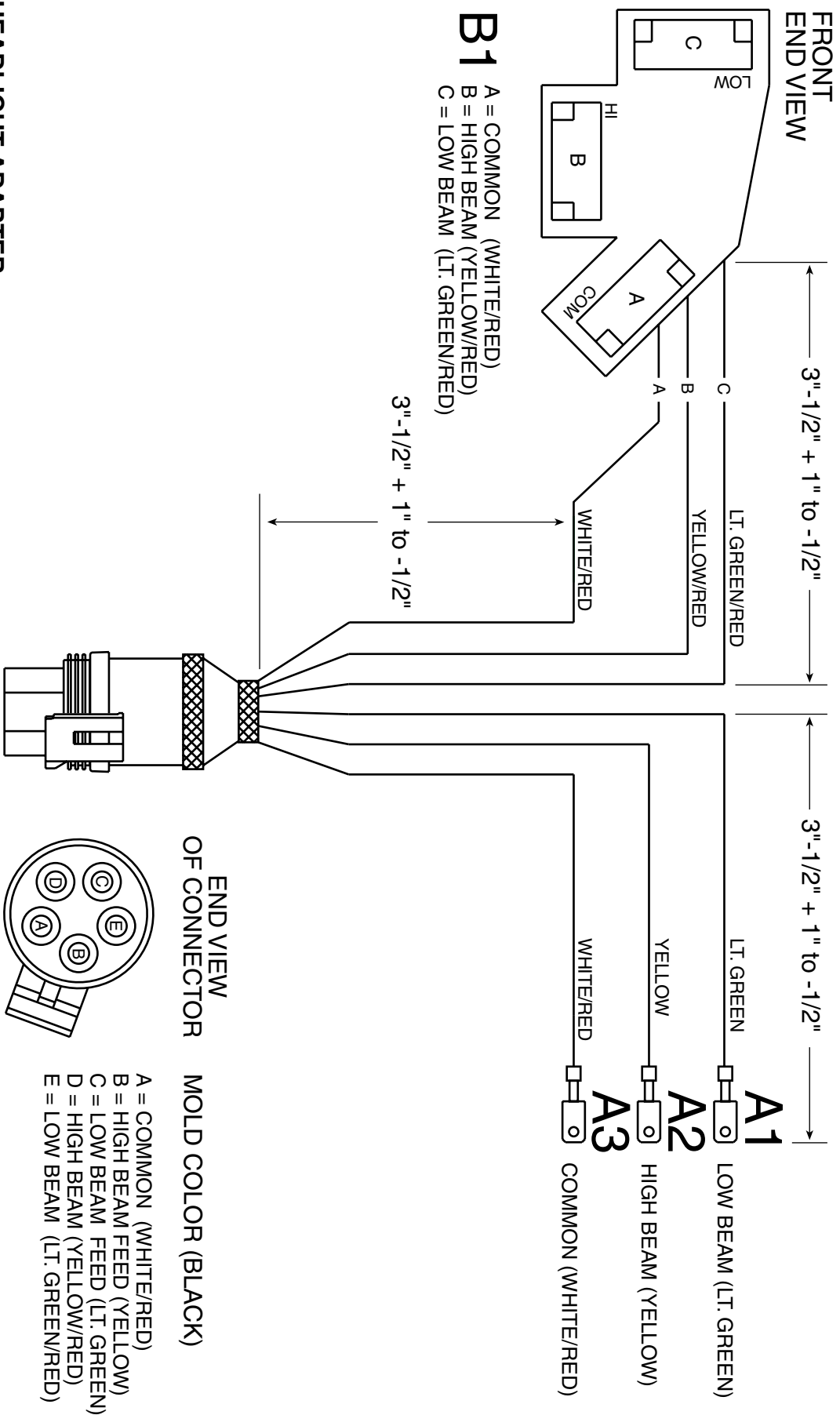

HEADLIGHT ADAPTER

P/N 62053

HEADLIGHT CONNECTOR(S): 2E
 HEADLIGHT DESCRIPTION: DUAL RECTANGULAR (SMALL) HALOGEN
 HEADLIGHT BULB NUMBER(S): H4666, H6545, HP6545

• NOT DRAWN TO SCALE
 • UNLESS OTHERWISE SPECIFIED ALL DIMENSIONS IN INCHES
 VENDOR P/N & DWG.: 95-2336-00 REV A (REF. M.P.M. 90-2020-00)

LIGHT ADAPTER NUMBER	VEHICLE MODEL APPLICATION
62054	98-03 S10 PICKUP/BLAZER/JIMMY/SONOMA*
	98-02 OLDS BRAVADA*
<p>Note: 62054 "A" Commons; The switch between high and low beams is on the negative (ground) side of the headlight bulb. Daytime running lights are run through the high beam bulbs.</p>	
	<p>NOTE: If vehicle model application is marked with an asterisk (*) then more than one light adapter may be specified. See light adapter diagrams and connector/adapter cross reference pages to determine which adapter is required.</p>

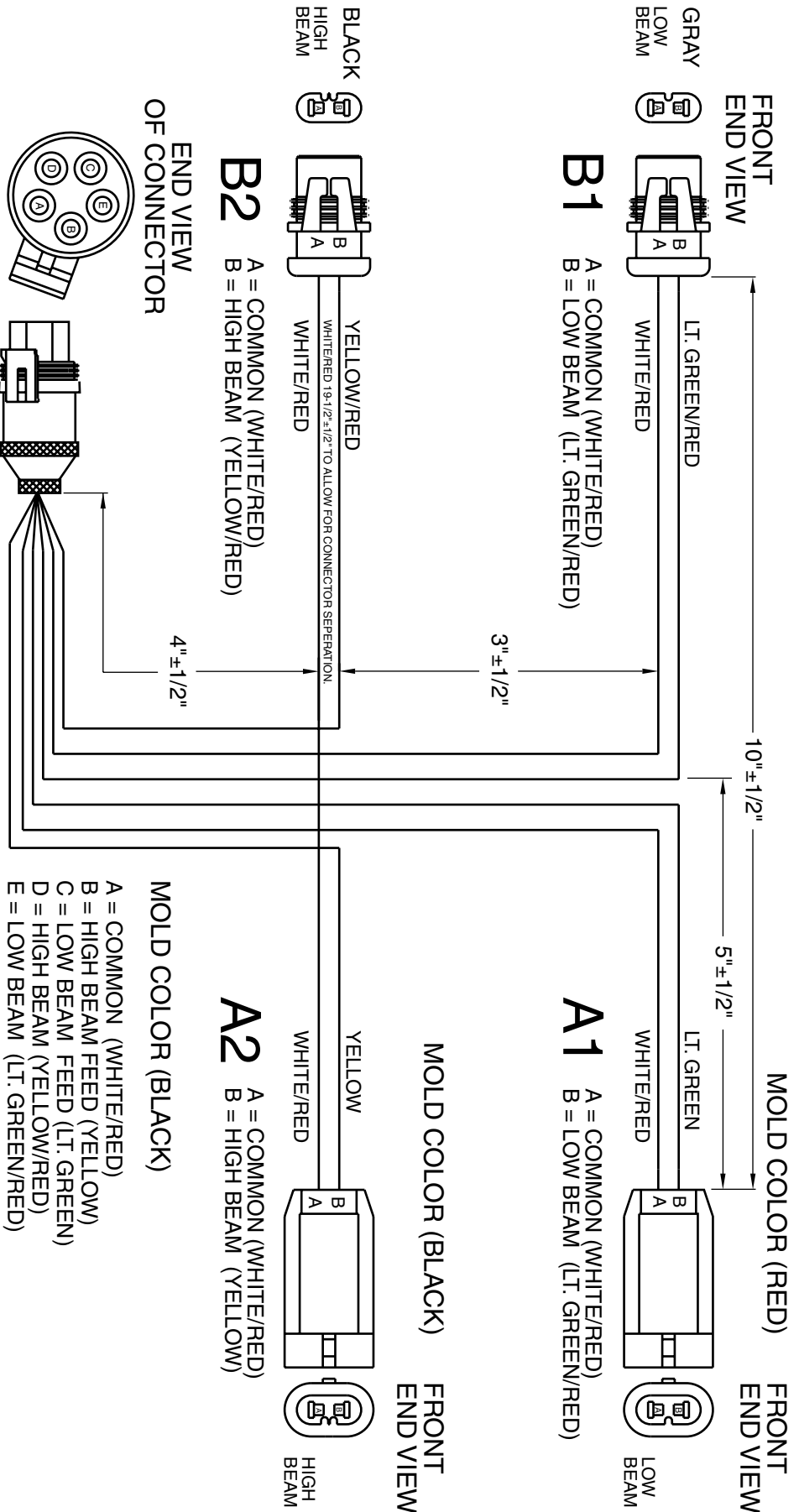

HEADLIGHT ADAPTER

P/N 62054

HEADLIGHT CONNECTOR(S): HB3/HB4
 HEADLIGHT DESCRIPTION: QUAD COMPOSITE HALOGEN LAMP
 HEADLIGHT BULB NUMBER(S): H9005, H9006

- NOT DRAWN TO SCALE
- UNLESS OTHERWISE SPECIFIED ALL DIMENSIONS IN INCHES

VENDOR P/N & DWG: 95-2357-00 (REF. M.P.M. 90-2030-01B REV A)

“A” COMMONS

NOTE: THE SWITCH BETWEEN LOW AND HIGH BEAMS IS ON THE NEGATIVE (GROUND) SIDE OF THE HEADLIGHT BULB. DAYTIME RUNNING LIGHTS ARE THROUGH THE HIGH BEAM BULBS.

HID MODULE

FRONT
END VIEW



FRONT
END VIEW

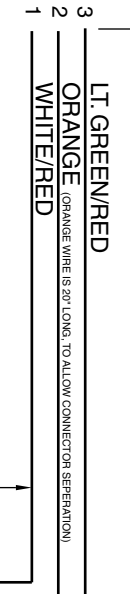
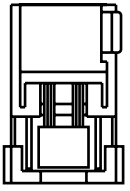
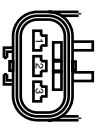

B1

- 1 = COMMON (WHITE/RED)
 - 2 = BATTERY POS + (ORANGE)
 - 3 = LOW BEAM (LT. GREEN/RED)
- NOTE: GM DOC I.D.# 1209020 IS INCORRECT

3" + 1/2"
to -1/4"

A1

- 1 = COMMON (WHITE/RED)
 - 2 = BATTERY POS + (ORANGE)
 - 3 = LOW BEAM (LT. GREEN/RED)
- NOTE: GM DOC I.D.# 1209020 IS INCORRECT

H9005

HIGH BEAM
BLACK

B2

- A = HIGH BEAM (YELLOW/RED)
- B = COMMON (WHITE/RED)

4" + 1/2"
to -1/4"

END VIEW
OF CONNECTOR

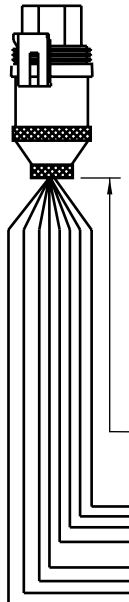
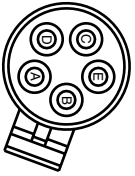

MOLD COLOR (BLACK)

A2

- A = HIGH BEAM (YELLOW)
- B = COMMON (WHITE/RED)

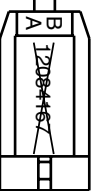

HIGH BEAM
BLACK

HEADLIGHT ADAPTER

P/N 62170

- HEADLIGHT CONNECTOR(S): HB3/HID
- HEADLIGHT DESCRIPTION: DUAL ROUND HIGH INTENSITY DISCHARGE (HID) LAMP
- HEADLIGHT BULB NUMBER(S): H9005 (HIGH BEAM), D1R-HID MODULE (LOW BEAM)

• NOT DRAWN TO SCALE
 • UNLESS OTHERWISE SPECIFIED ALL DIMENSIONS IN INCHES
 VENDOR P/N & DWG: 95-2356-00 (REF. M.P.M. 90-2029-01B)

LIGHT ADAPTER NUMBER	VEHICLE MODEL APPLICATION
62171	95-97 OLDS BRAVADA*
<p>Note: 62171"B" Commons; The switch between high and low beams is on the negative (ground) side of the headlight bulb. Daytime running lights are run through the high beam bulbs.</p>	
	<p>NOTE: If vehicle model application is marked with an asterisk (*) then more than one light adapter may be specified. See light adapter diagrams and connector/adapter cross reference pages to determine which adapter is required.</p>

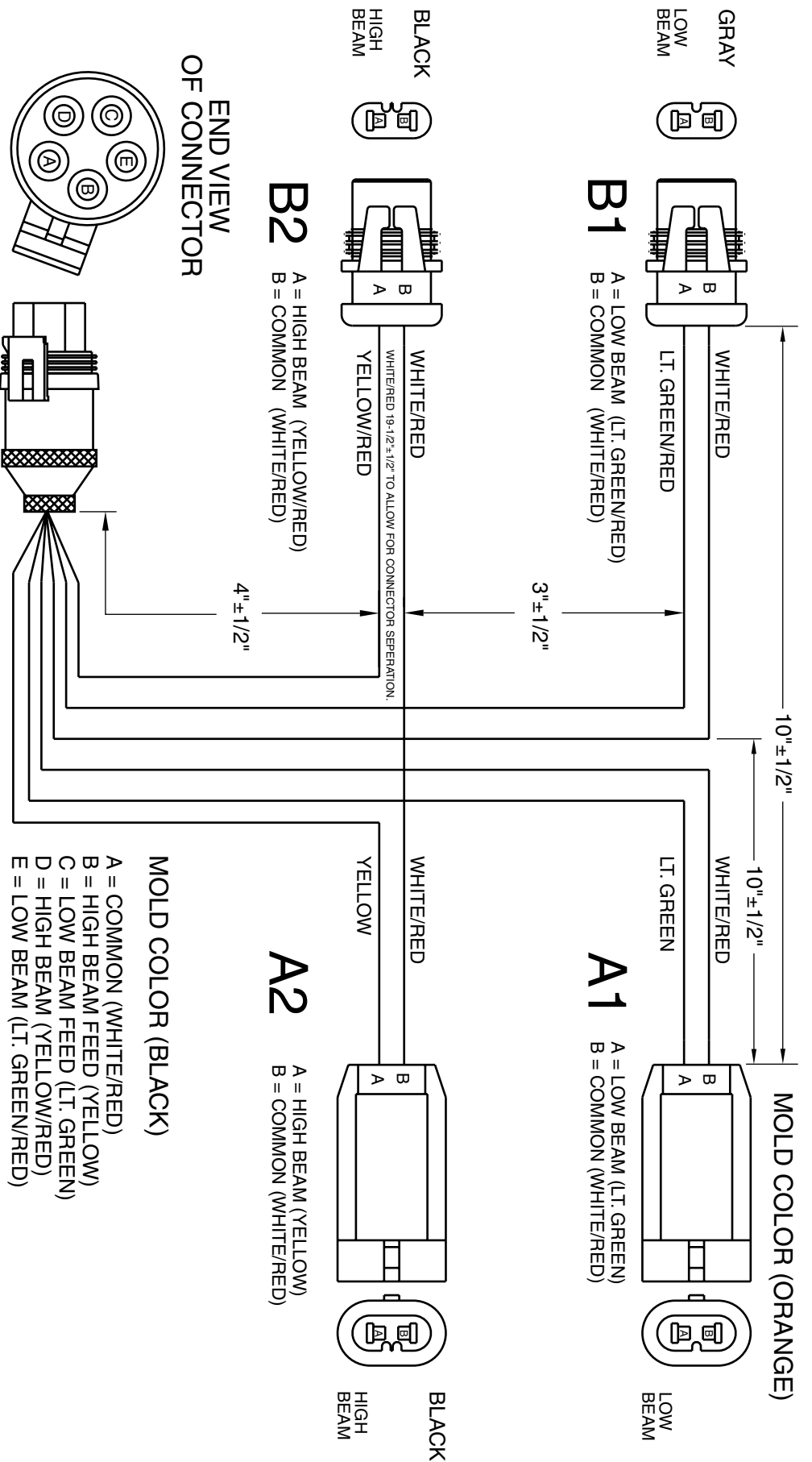

HEADLIGHT ADAPTER

P/N 62171

HEADLIGHT CONNECTOR(S):

HB3/HB4

HEADLIGHT DESCRIPTION:

QUAD COMPOSITE HALOGEN LAMP

HEADLIGHT BULB NUMBER(S): H9005, H9006

• NOT DRAWN TO SCALE

• UNLESS OTHERWISE SPECIFIED ALL DIMENSIONS IN INCHES

VENDOR P/N & DWG: 95-2358-00 (REF. M.P.M. 90-2031-01B REV A)

"B" COMMONS

NOTE: THE SWITCH BETWEEN LOW AND HIGH BEAMS IS ON THE NEGATIVE (GROUND) SIDE OF THE HEADLIGHT BULB. DAYTIME RUNNING LIGHTS ARE THROUGH THE HIGH BEAM BULBS.

LIGHT ADAPTER NUMBER	VEHICLE MODEL APPLICATION
62197	04 TRAILBLAZER/ENVOY
	NOTE: If vehicle model application is marked with an asterisk (*) then more than one light adapter may be specified. See light adapter diagrams and connector/adapter cross reference pages to determine which adapter is required.

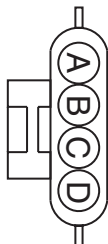
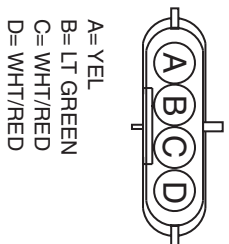

A= YEL/RED
B= GRN/RED
C= WHT/RED
D= WHT/RED

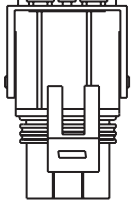
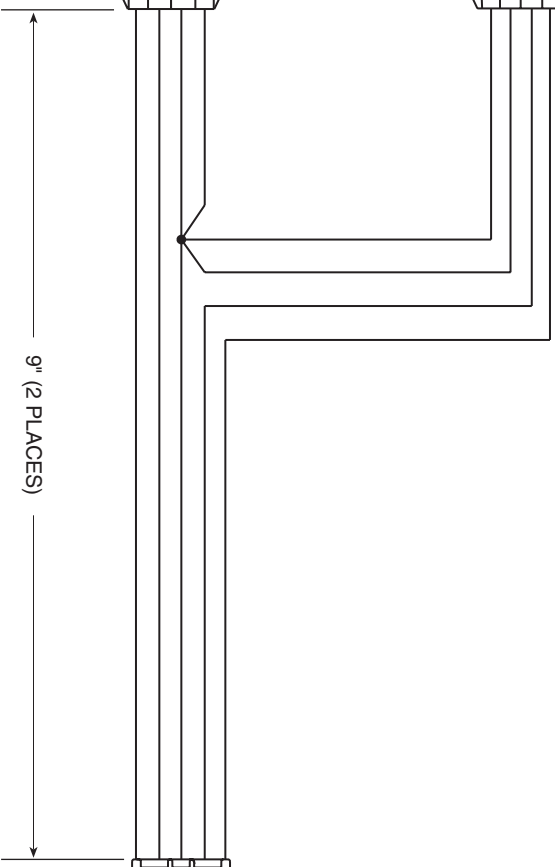
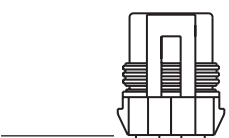
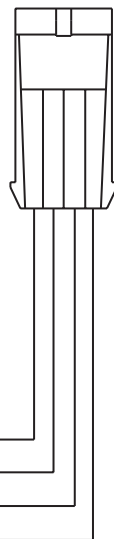

A= WHT/RED
B= YEL
C= LT GRN
D= YEL/RED
E= GRN/RED

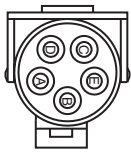

(COMMON)
(HIGH BEAM FEED)
(LOW BEAM FEED)
(HIGH BEAM)
(LOW BEAM)

HEADLIGHT ADAPTER

P/N 62197

HEADLIGHT CONNECTOR(S): HB3/HB4

HEADLIGHT DESCRIPTION: QUAD COMPOSITE HALOGEN

HEADLIGHT BULB NUMBER(S): H9005, H9006

- NOT DRAWN TO SCALE
 - UNLESS OTHERWISE SPECIFIED ALL DIMENSIONS IN INCHES
 - WIRE - 16 GA GPT
 - ALL CONNECTORS VIEWED FROM WIRE END EXCEPT WHERE NOTED
- VENDOR P/N & DWG: P-5607-FG REV A (REF: PCA DWG# P-5607-FG-DWG)

LIGHT ADAPTER NUMBER	VEHICLE MODEL APPLICATION
62199	04 NISSAN TITAN*
	NOTE: If vehicle model application is marked with an asterisk (*) then more than one light adapter may be specified. See light adapter diagrams and connector/adapter cross reference pages to determine which adapter is required.



VEHICLE UNDERCARRIAGE MODIFICATION NOTICE

CUSTOMER NAME:		DEALER:	
CUSTOMER ADDRESS:		STATE:	ZIP:
CUSTOMER TELEPHONE:	()		
VIN:			

MAKE:	FORD CHEV GMC DODGE	TOYOTA OTHER:	
MODEL:	(Ex. Silverado K2500 HD Pickup)		
YEAR:			
DATE OF MANUFACTURE:			
DRIVE TRAIN:	2WD 4WD ALL WHEEL	OTHER:	
DRW (DUAL REAR WHEELS)	YES NO		
BODY STYLE:	REG CAB X-CAB	OTHER:	
BOX OPTION(S):	DUMP BOX STAKE BED	OTHER:	
ENGINE TYPE:	GAS DIESEL		
ENGINE SIZE:	(Example: 6.0L V8)		
GFAWR:	LB	KG	
GRAWR:	LB	KG	
GVWR:	LB	KG	
HEADLAMP NUMBER(S):		DAYTIME RUNNING LIGHTS:	YES NO
HEADLAMP CONNECTOR:	(Ex. HB3/HB4, 1A/2A, LF/UF, etc.)		
BLIZZARD ADAPTER KIT:	62010 62011 62012 62013 62014 62015 62050 62051 62052 OTHER:		

MODIFY BUMPER:	YES NO		
BUMPER MOD IF. MADE:			
U.C. MOUNT INSTALLED:	P/N:		
MODIFY U.C. MOUNT:	YES NO	(IF YES: FAX OR MAIL TO BLIZZARD ENGINEERING -DOCUMENT CHANGE BELOW)	
U.C. MODIFICATION MADE:			
MAIL TO: BLIZZARD CORP. • 95 AIRPARK BLVD. • CALUMET, MI 49913		FAX TO: 906-482-5445	

BLIZZARD INSTALLER:		DATE OF INSTALL:	
PLOW MODEL INSTALLED:	680LT 720LT 760LT 760 800 860 810 8611 OTHER:		



LIMITED CONSUMER WARRANTY

This warranty covers defects in material and workmanship except as set forth below.

WARRANTED PARTY:

This warranty applies only to the "Original Purchaser" who purchased this plow from an Authorized Blizzard Dealer, for personal, family or household use.

TERM OF WARRANTY:

This Blizzard Power Plow snowplow is warranted for the following period:
Parts and labor are warranted for one year from date of purchase.

BLIZZARD CORPORATION'S WARRANTY REMEDY:

Blizzard Corporation will, at its sole discretion, repair or replace defective parts at no charge.

CUSTOMERS RESPONSIBILITY:

To obtain warranty service, the purchaser must return the defective snowplow to any Authorized Blizzard Dealer. The purchaser must verify the original purchase date. Transportation costs to and from the dealer will be the responsibility of the purchaser.

ITEMS NOT COVERED UNDER THIS WARRANTY:

This limited warranty does not cover the following:

1. Expendable parts such as cutting edges, plow shoes, hoses, fasteners, blade guides, paint finish, etc.
2. Any snowplow or part thereof which has been repaired or altered by anyone other than an Authorized Blizzard Dealer.
3. Any snowplow or part thereof which has been subject to neglect, misuse, accident, improper installation, maintenance, or storage. This includes, but is not limited to, corrosion of any electrical components.
4. Snowplows mounted on vehicles other than those for whom Blizzard Corporation has provided a specific undercarriage system.
5. Blizzard Corporation does not assume liability for damage to the purchaser's vehicle resulting from the attachment and use of a Blizzard Power Plow snowplow. Vehicle risk is the sole responsibility of the purchaser.

WARRANTY LIMITATIONS:

THIS WARRANTY IS OFFERED IN LIEU OF ANY OTHER EXPRESS WARRANTY.

THE DURATION OF ALL IMPLIED WARRANTIES, INCLUDING BUT NOT LIMITED TO THE IMPLIED WARRANTIES OF MERCHANTABILITY AND FITNESS FOR A PARTICULAR PURPOSE, ARE LIMITED TO THE DURATION OF THIS WARRANTY.

BLIZZARD CORPORATION'S LIABILITY IS EXPRESSLY LIMITED TO REPAIR OR REPLACEMENT OF DEFECTIVE PARTS. BLIZZARD CORPORATION SHALL NOT BE LIABLE FOR CONSEQUENTIAL, INCIDENTAL OR CONTINGENT DAMAGES WHATSOEVER, EVEN IF DAMAGES ARE CAUSED BY THE NEGLIGENCE OR FAULT OF BLIZZARD CORPORATION.

State Laws: Some states do not allow exclusion of incidental or consequential damages or the limitations on how long an implied warranty lasts, so these limitations or exclusions may not apply to you. This warranty gives you specific legal rights and you may also have other rights which vary from state to state.

This warranty does not apply if you purchased your snowplow for other than personal, family, or household use. If purchased for other than personal, family or household use, refer to the Blizzard Power Plow Commercial Warranty.





COMMERCIAL WARRANTY

This warranty covers defects in material and workmanship except as set forth below.

WARRANTED PARTY:

This warranty applies only to the "Original Purchaser" who purchased this plow from an Authorized Blizzard Dealer, for commercial use.

TERM OF WARRANTY:

This Blizzard Power Plow snowplow is warranted for the following period:
Parts and labor are warranted for one year from date of purchase.

BLIZZARD CORPORATION'S WARRANTY REMEDY:

Blizzard Corporation will, at its sole discretion, repair or replace defective parts at no charge.

CUSTOMERS RESPONSIBILITY:

To obtain warranty service, the purchaser must return the defective snowplow to any Authorized Blizzard Dealer within the warranty period. The purchaser must verify the original purchase date. Transportation costs to and from the Dealer will be the responsibility of the purchaser.

ITEMS NOT COVERED UNDER THIS WARRANTY:

This warranty does not cover the following:

1. Expendable parts such as cutting edges, plow shoes, hoses, fasteners, blade guides, paint finish, etc.
2. Any snowplow or part thereof which has been repaired or altered by anyone other than an Authorized Blizzard Dealer.
3. Any snowplow or part thereof which has been subject to neglect, misuse, accident, improper installation, maintenance, or storage. This includes, but is not limited to, corrosion of any electrical components.
4. Snowplows mounted on vehicles other than those for whom Blizzard Corporation has provided a specific undercarriage system.
5. Blizzard Corporation does not assume liability for damage to the purchaser's vehicle resulting from the attachment and use of a Blizzard Power Plow snowplow. Vehicle risk is the sole responsibility of the purchaser.

LIMITS OF BLIZZARD CORPORATION'S LIABILITIES:

BLIZZARD CORPORATION'S LIABILITY IS EXPRESSLY LIMITED TO REPAIR OR REPLACEMENT OF DEFECTIVE PARTS. BLIZZARD CORPORATION SHALL NOT BE LIABLE FOR CONSEQUENTIAL, INCIDENTAL OR CONTINGENT DAMAGES WHATSOEVER, EVEN IF DAMAGES ARE CAUSED BY THE NEGLIGENCE OR FAULT OF BLIZZARD CORPORATION.

THE FOREGOING WARRANTIES ARE EXCLUSIVE AND IN LIEU OF ALL OTHER EXPRESSED AND IMPLIED WARRANTIES INCLUDING, BUT NOT LIMITED TO, THE IMPLIED WARRANTIES OF MERCHANTABILITY AND FITNESS FOR A PARTICULAR PURPOSE.

This warranty does not apply if you purchased your snowplow for personal, family, or household use.
In this case, refer to the Blizzard Power Plow Limited Consumer Warranty.





LIMITED CONSUMER WARRANTY

This warranty covers defects in material and workmanship except as set forth below.

WARRANTED PARTY:

This warranty applies only to the "Original Purchaser" who purchased this plow from an Authorized Blizzard Dealer, for personal, family or household use.

TERM OF WARRANTY:

This Blizzard straight blade snowplow is warranted for the following period:
Parts and labor are warranted for one year from date of purchase.

BLIZZARD CORPORATION'S WARRANTY REMEDY:

Blizzard Corporation will, at its sole discretion, repair or replace defective parts at no charge.

CUSTOMERS RESPONSIBILITY:

To obtain warranty service, the purchaser must return the defective snowplow to any Authorized Blizzard Dealer. The purchaser must verify the original purchase date. Transportation costs to and from the dealer will be the responsibility of the purchaser.

ITEMS NOT COVERED UNDER THIS WARRANTY:

This limited warranty does not cover the following:

1. Expendable parts such as cutting edges, plow shoes, hoses, fasteners, blade guides, paint finish, etc.
2. Any snowplow or part thereof which has been repaired or altered by anyone other than an Authorized Blizzard Dealer.
3. Any snowplow or part thereof which has been subject to neglect, misuse, accident, improper installation, maintenance, or storage. This includes, but is not limited to, corrosion of any electrical components.
4. Snowplows mounted on vehicles other than those for whom Blizzard Corporation has provided a specific undercarriage system.
5. Blizzard Corporation does not assume liability for damage to the purchaser's vehicle resulting from the attachment and use of a Blizzard straight blade snowplow. Vehicle risk is the sole responsibility of the purchaser.

WARRANTY LIMITATIONS:

THIS WARRANTY IS OFFERED IN LIEU OF ANY OTHER EXPRESS WARRANTY.

THE DURATION OF ALL IMPLIED WARRANTIES, INCLUDING BUT NOT LIMITED TO THE IMPLIED WARRANTIES OF MERCHANTABILITY AND FITNESS FOR A PARTICULAR PURPOSE, ARE LIMITED TO THE DURATION OF THIS WARRANTY.

BLIZZARD CORPORATION'S LIABILITY IS EXPRESSLY LIMITED TO REPAIR OR REPLACEMENT OF DEFECTIVE PARTS. BLIZZARD CORPORATION SHALL NOT BE LIABLE FOR CONSEQUENTIAL, INCIDENTAL OR CONTINGENT DAMAGES WHATSOEVER, EVEN IF DAMAGES ARE CAUSED BY THE NEGLIGENCE OR FAULT OF BLIZZARD CORPORATION.

State Laws: Some states do not allow exclusion of incidental or consequential damages or the limitations on how long an implied warranty lasts, so these limitations or exclusions may not apply to you. This warranty gives you specific legal rights and you may also have other rights which vary from state to state.

This warranty does not apply if you purchased your snowplow for other than personal, family, or household use. If purchased for other than personal, family or household use, refer to the Blizzard Straight Blade Commercial Warranty.





COMMERCIAL WARRANTY

This warranty covers defects in material and workmanship except as set forth below.

WARRANTED PARTY:

This warranty applies only to the "Original Purchaser" who purchased this plow from an Authorized Blizzard Dealer, for commercial use.

TERM OF WARRANTY:

This Blizzard straight blade snowplow is warranted for the following period:
Parts and labor are warranted for one year from date of purchase.

BLIZZARD CORPORATION'S WARRANTY REMEDY:

Blizzard Corporation will, at its sole discretion, repair or replace defective parts at no charge.

CUSTOMERS RESPONSIBILITY:

To obtain warranty service, the purchaser must return the defective snowplow to any Authorized Blizzard Dealer within the warranty period. The purchaser must verify the original purchase date. Transportation costs to and from the Dealer will be the responsibility of the purchaser.

ITEMS NOT COVERED UNDER THIS WARRANTY:

This warranty does not cover the following:

1. Expendable parts such as cutting edges, plow shoes, hoses, fasteners, blade guides, paint finish, etc.
2. Any snowplow or part thereof which has been repaired or altered by anyone other than an Authorized Blizzard Dealer.
3. Any snowplow or part thereof which has been subject to neglect, misuse, accident, improper installation, maintenance, or storage. This includes, but is not limited to, corrosion of any electrical components.
4. Snowplows mounted on vehicles other than those for whom Blizzard Corporation has provided a specific undercarriage system.
5. Blizzard Corporation does not assume liability for damage to the purchaser's vehicle resulting from the attachment and use of a Blizzard straight blade snowplow. Vehicle risk is the sole responsibility of the purchaser.

LIMITS OF BLIZZARD CORPORATION'S LIABILITIES:

BLIZZARD CORPORATION'S LIABILITY IS EXPRESSLY LIMITED TO REPAIR OR REPLACEMENT OF DEFECTIVE PARTS. BLIZZARD CORPORATION SHALL NOT BE LIABLE FOR CONSEQUENTIAL, INCIDENTAL OR CONTINGENT DAMAGES WHATSOEVER, EVEN IF DAMAGES ARE CAUSED BY THE NEGLIGENCE OR FAULT OF BLIZZARD CORPORATION.

THE FOREGOING WARRANTIES ARE EXCLUSIVE AND IN LIEU OF ALL OTHER EXPRESSED AND IMPLIED WARRANTIES INCLUDING, BUT NOT LIMITED TO, THE IMPLIED WARRANTIES OF MERCHANTABILITY AND FITNESS FOR A PARTICULAR PURPOSE.

This warranty does not apply if you purchased your snowplow for personal, family, or household use. In this case, refer to the Blizzard Straight Blade Limited Consumer Warranty.





95 Airpark Boulevard
Calumet, MI 49913
[888] 680-8600
[906] 482-5555
[906] 482-5445 Fax
www.blizzardplows.com

Blizzard, Power Plow, WidePass, BucketBlade, Power Hitch and Seat Cinch are trademarks of Blizzard Corporation. Blizzard and Power Plow are registered in the United States Patent and Trademark Office. All other trademarks and registered trademarks are the property of their respective owners. All Blizzard snowplows are protected by one or more of the following United States Patents: 5,638,618; 5,899,007; 6,178,669; 6,276,076; 6,393,737 and 6,615,513. Other patents pending. © 2004 Blizzard Corporation. All rights reserved. 64008-A